



ROLLER CHAIN SPROCKETS

PRODUCT	PAGE
INDEX	E-1 - E-2
MADE-TO-ORDER CAPABILITIES	E-3
SECTION I – STANDARD SPROCKETS	E-4 - E-112
Shear Pin Sprockets, Bolt-On	E-4 - E-6
Type D Sprockets, Detachable Hubs Split and Solid	E-7
Instant Split® Sprockets	E-8
Torque Limiter	E-9 - E-10
Double Pitch Sprockets	E-11 - E-15
Double Single Sprockets	(See Pitch Below)
Sprockets, Stock	E-16 - E-112
No. 25 – ¼" pitch	E-16 - E-17
No. 35 – ⅜" pitch	E-18 - E-26
No. 41 – ½" pitch	E-27 - E-29
No. 40 – ½" pitch	E-30 - E-42
No. 50 – ⅝" pitch	E-43 - E-55
No. 60 – ¾" pitch	E-56 - E-68
No. 80 – 1" pitch	E-69 - E-81
No. 100 – 1¼" pitch	E-82 - E-91
No. 120 – 1½" pitch	E-92 - E-97
No. 140 – 1¾" pitch	E-98- E-102
No. 160 – 2" pitch	E-103 - E-107
No. 180 – 2¼" pitch	E-108
No. 200 – 2½" pitch	E-109 - E-111
No. 240 – 3" pitch	E-112
SECTION II – METRIC SPROCKETS	E-113 - E-151
ISO - 06B-1, Metric 35 - 0.375 in. (9.525mm) Pitch, Simplex	E-114 – E-115
ISO - 06B-2, Metric 35-2 - 0.375 in. (9.525mm) Pitch, Duplex	E-116 – E-117
ISO - 06B-3, Metric 35-3 - 0.375 in. (9.525mm) Pitch, Triplex	E-118
ISO - 08B-1, Metric 40 - 0.500 in. (12.70mm) Pitch, Simplex	E-119 – E-120
ISO - 08B-2, Metric 40-2 - 0.500 in. (12.70mm) Pitch, Duplex	E-121 – E122
ISO - 08B-3, Metric 40-3 - 0.500 in. (12.70mm) Pitch, Triplex	E-123
ISO - 10B-1, Metric 50 - 0.625 in. (15.88mm) Pitch, Simplex	E-124 – E-125
ISO - 10B-2, Metric 50-2 - 0.625 in. (15.88mm) Pitch, Duplex	E-126 – E-127
ISO - 10B-3, Metric 50-3 -0.625 in. (15.88mm) Pitch, Triplex	E-128
ISO - 12B-1, Metric 60 - 0.750 in. (19.05mm) Pitch, Simplex	E-129 – E-130
ISO - 12B-2, Metric 60-2 - 0.750 in. (19.05mm) Pitch, Duplex	E-131 – E-132
ISO - 12B-3, Metric 60-3 - 0.750 in. (19.05mm) Pitch, Triplex	E-133
ISO - 16B-1, Metric 80 - 1.000 in. (25.40mm) Pitch, Simplex	E-134 – E-135

SPROCKETS

ROLLER CHAIN SPROCKETS

PRODUCT

PAGE

SECTION II – METRIC SPROCKETS (continued)

ISO - 16B-2, Metric 80-2 - 1.000 in. (25.40mm) Pitch, Duplex.....	E-136 – E-137
ISO - 16B-3, Metric 80-3 - 1.000 in. (25.40mm) Pitch, Triplex	E-138
ISO - 20B-1, Metric 100 - 1.250 in. (31.75mm) Pitch, Simplex	E-139 – E-140
ISO - 20B-2, Metric 100-2 - 1.250 in. (31.75mm) Pitch, Duplex	E-141
ISO - 20B-3, Metric 100-3 - 1.250 in. (31.75mm) Pitch, Triplex	E-142
ISO - 24B-1, Metric 120 - 1.500 in. (38.10mm) Pitch, Simplex	E-143 – E-144
ISO - 24B-2, Metric 120-2 - 1.500 in. (38.10mm) Pitch, Duplex	E-145
ISO - 28B-1, Metric 140 - 1.750 in. (44.45mm) Pitch, Simplex	E-146 – E-147
ISO - 28B-2, Metric 140-2 - 1.750 in. (44.45mm) Pitch, Duplex	E-148
ISO - 32B-1, Metric 160 - 2.00 in. (50.80mm) Pitch, Simplex	E-149 – E-150
ISO - 32B-2, Metric 160-2 - 2.00 in. (50.80mm) Pitch, Simplex	E-151

SECTION III – ENGINEERING.....E-152 – E-192

Sprocket Nomenclature	E-153 – E-155
Roller Chain Dimensions.....	E-156
Sprocket Tooth Dimensions.....	E-157
Maximum Bore and Hub Size	E-158 – E-159
Sprocket Selection	E-160– E-163
Sprocket Engineering	E-164 – E-166
Hardening.....	E-167
Chain Drive Engineering	E-168 – E-169
Roller Chain Lengths.....	E-169
Speed Ratios.....	E-170
Sprocket Diameters.....	E-171 – E-183
Horsepower Ratings.....	E-184 – E-192

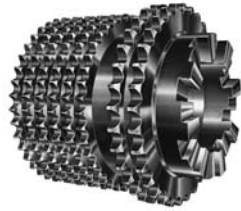

Multi-Strand Oil Field Sprocket with Clutch Jaws



Triple 160 Shaft Sprocket



Quadruple 160 Sprocket



Triple 200 Sprocket



Double 200 Sprocket and Pinion



Large Triple Strand Sprocket with Mounting Flange



Sprocket with Mud Relief



Standard RC Sprocket with Spline Bore



Special Dryer Sprocket



Special Plastic Sprocket



Block Chain

Martin manufactures numerous Made-To-Order (MTO) sprockets. If you do not see the sprocket you need in this section, call us. Chances are if chain runs on it, we have made the sprocket before. Special materials, special bores, duplex, triplex, double-single-doubles, etc. are all familiar to *Martin*.

Bolt-On Shear Pin Sprockets



Shear Pin sprockets provide simple, dependable protection against expensive machinery damage caused by overloads or jamming. Torque is transmitted by a single pin, necked to shear when the safe load is exceeded. When an overload occurs, the pin shears, disconnecting the drive immediately.

The Bolt-on Shear Pin Adapter converts any plate sprocket into a stock Shear Pin sprocket allowing immediate delivery of stock Shear Pin sprockets.

Selection guide on page E-6 gives complete procedure to select the proper Shear Pin assembly.

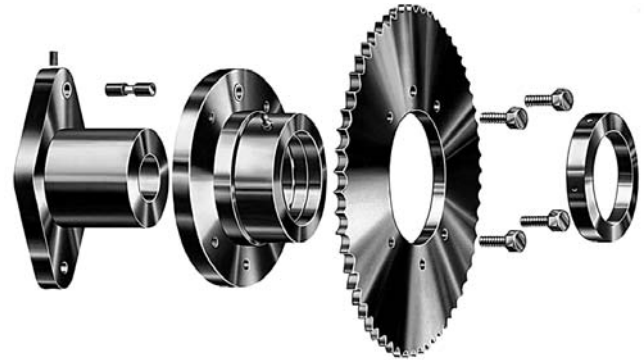

SPROCKETS

Stock Shear Pin Assemblies

Shear Pin Assembly Number	Hub Bore Range	Shear Pin Hub	Shear Pin Adapter
		Catalog Number	Catalog Number
SP-17	1" & UNDER	SPH-17	SPA-17
SP-18	1 ¹ / ₆ -1 ¹ / ₄	SPH-18	SPA-18
SP-19	1 ¹ / ₆ -1 ¹ / ₂	SPH-19	SPA-19
SP-20	1 ¹ / ₆ -1 ³ / ₄	SPH-20	SPA-20
SP-21	1 ¹ / ₆ -2	SPH-21	SPA-21
SP-22	2 ¹ / ₆ -2 ¹ / ₄	SPH-22	SPA-22
SP-23	2 ¹ / ₆ -2 ¹ / ₂	SPH-23	SPA-23
SP-24	2 ¹ / ₆ -2 ³ / ₄	SPH-24	SPA-24
SP-25	2 ³ / ₆ -3	SPH-25	SPA-25
SP-26	3 ¹ / ₆ -3 ¹ / ₄	SPH-26	SPA-26
SP-27	3 ¹ / ₆ -4	SPH-27	SPA-27
SP-28	4 ¹ / ₆ -4 ¹ / ₂	SPH-28	SPA-28
SP-29	4 ¹ / ₆ -5	SPH-29	SPA-29
SP-30	4 ¹ / ₆ -5 ¹ / ₂	SPH-30	SPA-30
SP-31	5 ¹ / ₆ -6	SPH-31	SPA-31

Notes on Pricing:

Shear Pin Hub List Price includes any finished bore within the stated range, standard keyway, setscrew, and hardened steel shear pin bushing.

Shear Pin Adapter List Price includes the Shear Pin bushin and grease fitting.

Complete Assembly List Price includes all components of the Shear Pin assembly as described above. Total list price of any Shear Pin sprocket is the complete assembly list price plus the list price of the desired plate sprocket (from tables of stock sprocket list prices).

Replacement Sprockets should be priced as altered stock sprockets directly from List Price and Alteration Charge tables.

Shear Pin Components may be ordered separately and will be treated as stock items when conforming to standard specifications and descriptions above.

Pricing Examples:

1. Stock Shear Pin Sprocket

To price a 35 tooth shear pin sprocket for 160 chain (160SP35) using SP-26 shear pin assembly with 3¹/₆" bore, standard keyway and setscrew:

SP-26 Assembly List Price.....
160A35 List Price

See List Price Sheet

Total List Price

2. Shear Pin Adapter and Sprocket for Existing Hub

To price a "Bolt-on" shear pin adapter and sprocket to replace the sprocket part of existing 50SP40 using SP-19 hub:

SPA-19 Adapter List Price.....
50A40 List Price

See List Price Sheet

Total List Price

Shear Pin Sprockets can also be furnished in other standard styles or made to customer's specifications. Price on application.

It is important that the torque requirement for the selected hub be checked in the torque rating table on page E-6 and the neck diameter of Shear Pin be specified.

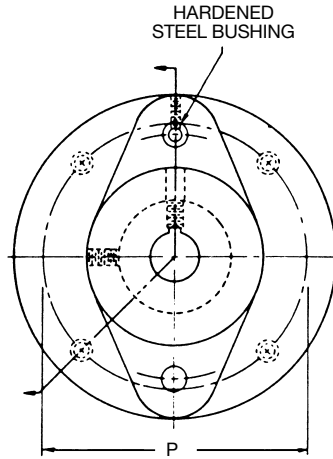
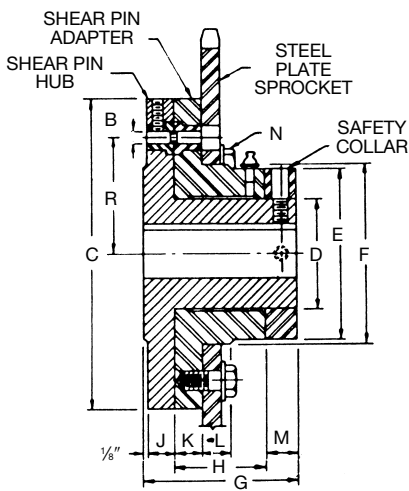

Shear Pin Assembly Dimensions (Inches)

Table I

Shear Pin Assembly Number	Shear Pin		Diameters				Length Thru			Hub Flange Thickness	Adapt. Flange Thickness	Sprocket Seat Width	Bolts		Weights (lbs.)	
	Radius	Pin Dia.	Flange	Shear Pin Hub	Adapt. Hub & Collar	Sprocket Seat	Shear Pin Hub	Adapt.	Collar				Number & Size	Bolt Circle	Shear Pin Hub	Shear Pin Adapt.
	R	B	C	D	E	F	G	H	M				J	K	L	N
SP-17	1 ¹³ / ₁₆	1/4	5 ¹ / ₄	1 ¹ / ₄	2 ¹ / ₂	2 ³ / ₈	2 ⁷ / ₁₆	1 ¹ / ₈	3/8	3/16	3/16	3/16	4-3/8"	4	2.7	3.2
SP-18	2 ¹ / ₁₆	1/4	6	2 ¹ / ₄	3 ¹ / ₄	3 ³ / ₈	2 ¹ / ₁₆	1 ¹ / ₈	1/2	3/16	3/16	3/16	4-3/8"	4 ³ / ₈	4.6	4.7
SP-19	2 ¹ / ₁₆	3/8	6 ¹ / ₄	2 ¹ / ₄	4	4 ¹ / ₈	3 ¹ / ₁₆	2 ¹ / ₈	3/8	1/16	1/16	1/16	4-1/2"	5 ¹ / ₂	7.2	7.6
SP-20	3	3/8	7 ¹ / ₄	3 ¹ / ₄	4 ¹ / ₄	4 ¹ / ₈	4 ¹ / ₁₆	2 ¹ / ₂	3/4	1/16	1/16	1/16	4-1/2"	6 ¹ / ₄	11.0	11.9
SP-21	3 ³ / ₁₆	7/8	8 ¹ / ₄	3 ¹ / ₄	5 ¹ / ₄	5 ¹ / ₈	4 ¹ / ₁₆	2 ¹ / ₈	7/8	1/16	1/16	1/16	4-5/8"	7	16.2	16.9
SP-22	3 ³ / ₁₆	1/2	9 ¹ / ₄	4 ¹ / ₄	6 ¹ / ₄	6 ¹ / ₈	5 ¹ / ₁₆	3	1	1/16	1/16	1/16	4-5/8"	8	23.3	24.5
SP-23	4	1/2	10	4 ¹ / ₂	6 ¹ / ₂	6 ¹ / ₈	5 ¹ / ₁₆	3 ¹ / ₂	1	1/16	1/16	1/16	4-5/8"	8 ¹ / ₄	26.3	27.7
SP-24	4 ³ / ₈	3/8	11 ¹ / ₂	5	7	7 ¹ / ₈	6 ¹ / ₁₆	3 ¹ / ₄	1 ¹ / ₂	1/16	1/16	1/16	4-5/8"	9 ¹ / ₄	40.4	38.6
SP-25	4 ³ / ₈	3/8	12 ¹ / ₂	5 ¹ / ₂	8	8 ¹ / ₈	6 ¹ / ₁₆	4 ¹ / ₄	1 ¹ / ₄	1/16	1/16	1/16	6-5/8"	10 ¹ / ₄	52.6	53.6
SP-26	5 ⁵ / ₁₆	1/16	13 ¹ / ₂	6 ¹ / ₄	8 ³ / ₄	8 ¹ / ₄	7 ¹ / ₁₆	4 ¹ / ₄	1 ¹ / ₂	1/16	1/16	1/16	6-5/8"	11 ¹ / ₄	66.7	66.8
SP-27	6 ¹ / ₁₆	3/8	15 ¹ / ₂	7	10	10 ¹ / ₈	8 ¹ / ₁₆	5 ¹ / ₂	1 ¹ / ₂	1/16	1/16	1/16	6-5/8"	12 ¹ / ₂	96.5	100.0
SP-28	6 ¹ / ₁₆	3/8	16 ¹ / ₄	7 ¹ / ₄	10 ¹ / ₄	10 ¹ / ₈	9 ¹ / ₁₆	6 ¹ / ₂	1 ¹ / ₂	1/16	1/16	1/16	6-3/4"	13 ¹ / ₂	125.0	115.0
SP-29	7 ¹ / ₈	7/8	17 ¹ / ₂	8 ¹ / ₂	12	12 ¹ / ₈	10 ¹ / ₁₆	7	1 ¹ / ₂	1 ¹ / ₁₆	1/16	1/16	6-1"	14 ¹ / ₂	160.0	150.0
SP-30	8 ¹ / ₈	1	20 ¹ / ₄	9 ¹ / ₄	13 ¹ / ₄	13 ¹ / ₈	11 ¹ / ₁₆	7 ¹ / ₂	2	2 ¹ / ₁₆	1/16	1/16	6-1"	17	215.0	207.0
SP-31	8 ¹ / ₈	1 ¹ / ₈	22 ¹ / ₂	10 ¹ / ₄	15	15 ¹ / ₈	12 ¹ / ₁₆	8 ¹ / ₂	2 ¹ / ₄	2 ¹ / ₁₆	1/16	1/16	6-1"	18 ¹ / ₂	318.0	265.0

NOTE: Shear Pin "Pin" length equals 2 x "J" dimension.

Sprocket Sizes For Stock Shear Pin Assemblies

Table II

Shear Pin Assembly Number	Hub Bore Range	Minimum Number of Teeth for Single Sprockets												
		Chain Number												
		35	41	40	50	60	80	100	120	140	160	180	200	240
SP-17	1" & UNDER	48	37	37	30	26	—	—	—	—	—	—	—	—
SP-18	1 ¹ / ₁₆ -1 ¹ / ₄	55	42	42	34	29	23	—	—	—	—	—	—	—
SP-19	1 ¹ / ₁₆ -1 ¹ / ₂	61	46	47	38	32	25	21	—	—	—	—	—	—
SP-20	1 ¹ / ₁₆ -1 ³ / ₄	69	53	53	43	36	28	23	—	—	—	—	—	—
SP-21	1 ¹ / ₁₆ -2	78	59	59	48	41	31	26	22	19	—	—	—	—
SP-22	2 ¹ / ₁₆ -2 ¹ / ₄	86	65	66	53	45	34	28	24	21	19	17	—	14
SP-23	2 ¹ / ₁₆ -2 ¹ / ₂	89	67	67	55	46	35	29	25	22	19	18	16	14
SP-24	2 ¹ / ₁₆ -2 ³ / ₄	101	76	77	62	52	40	33	28	24	22	20	18	16
SP-25	2 ¹ / ₁₆ -3	110	83	83	67	56	43	35	30	26	23	21	19	17
SP-26	3 ¹ / ₁₆ -3 ¹ / ₂	—	98	98	72	61	46	38	32	28	25	23	20	18
SP-27	3 ¹ / ₁₆ -4	—	102	102	82	69	53	43	36	32	28	25	23	20
SP-28	4 ¹ / ₁₆ -4 ¹ / ₂	—	107	107	86	72	55	45	38	33	29	26	24	21
SP-29	4 ¹ / ₁₆ -5	—	—	—	92	77	59	48	40	35	31	28	26	22
SP-30	5 ¹ / ₁₆ -5 ¹ / ₂	—	—	—	106	89	68	55	46	40	35	32	29	25
SP-31	5 ¹ / ₁₆ -6	—	—	—	—	98	75	61	51	44	39	35	32	27

Bolt-On Shear Pin Sprockets



Shear Pin Sprocket Selection

- The shear pin assembly required is determined by the shaft size. Select the smallest shear pin assembly which will accommodate the required bore. Table on page E-5 contains the bore ranges and minimum sprocket sizes which allow chain clearance over the shear pin assembly flange.
- Using one of the following formulas, compute the torque load the pin must transmit and find the value in the torque rating table below to obtain the proper shear pin neck diameter.

$$T = \frac{HP \times 63,000 \times 1.5}{RPM} \quad \text{or} \quad T = \frac{D \times CP \times 1.5}{2}$$

or T = Output of reducer x speed ratio of chain drive x 1.5

- Where:
- T = Torque in pound inches
 - HP = Horsepower at Sprocket
 - RPM = Sprocket Speed
 - D = Pitch Diameter of Sprocket
 - CP = Chain pull in pounds
 - 1.5 = Safety factor for starting load

Example:

- Determine the shear pin assembly and pin neck diameter to transmit 20 horsepower at 67 RPM with a 45 tooth, No. 100 sprocket on a 2¹⁵/₁₆" shaft.

(1) Referring to Table I (page E-5), shear pin assembly SP-25 is required for a 2¹⁵/₁₆" bore. The 45 tooth sprocket is well above the minimum size.

(2) Torque and neck diameter:

$$T = \frac{HP \times 63,000 \times 1.5}{RPM}$$

$$T = \frac{20 \times 63,000 \times 1.5}{67} = 28,200 \text{ lb. in.}$$

Referring to Table II (page E-5) under SP-25, a pin necked to ³/₈" shows a torque rating of 29,810 lb. in., which exceeds the 28,200 lb. in. required.

(3) Order: 100SP45, SP-25 assembly with 2¹⁵/₁₆" bore and ³/₈" pin neck diameter.

Shear Pin Torque Ratings

Shear Pin Neck Diameter (inches)	TORQUE RATING — POUND INCHES															
	Shear Pin Hub Number															
	SP17	SP18	SP19	SP20	SP21	SP22	SP23	SP24	SP25	SP26	SP27	SP28	SP29	SP30	SP31	
¹ / ₂	728	875	1022	1204	1323	1556	1603									
¹ / ₄	1248	1500	1752	2064	2268	2616	2748									
³ / ₃₂	1976	2375	2774	3268	3591	4142	4351	4750								
¹ / ₁₆	2808	3375	3942	4944	5103	5886	6183	6750	7317							
⁷ / ₃₂	3848	4625	5402	6364	6993	8066	8473	9250	10027							
¹ / ₄	5200	6250	7300	8600	9450	10900	11450	12500	13550	15200	17300	18400				
⁹ / ₃₂			9052	10664	11718	13516	14198	15500	16802	18848	21452	22816				
⁵ / ₁₆			11096	13072	14364	16568	17403	19000	20596	23140	26296	27968	30932			
¹¹ / ₃₂				15824	17388	20056	21068	23000	24932	27968	31832	33856	37440			
³ / ₈				18920	20790	23980	25190	27500	29810	33440	38060	40480	44770	51040		
¹³ / ₃₂					24570	28340	29170	32500	35230	39520	44980	47840	52910	60320		
⁷ / ₁₆					28350	32700	34350	37500	41650	45600	51900	55200	61050	69600		
¹⁵ / ₃₂						37060	38930	42500	46070	51680	58820	62560	69190	78880		
¹ / ₂						42728	44884	49000	53116	59584	67816	72128	79772	90944		
¹⁷ / ₃₂								55000	59620	66880	76120	80960	89540	102080		
⁹ / ₁₆								62000	67280	75392	85808	91264	100936	115072		
¹⁹ / ₃₂									73220	82080	93420	99360	109890	125280	136890	
⁵ / ₈									82800	92720	105530	112240	124135	141520	154635	
²¹ / ₃₂										103360	117640	126120	138380	157760	172380	
¹¹ / ₁₆										112480	128020	136160	150590	171680	187590	
²³ / ₃₂											138400	147200	162800	185600	202800	
³ / ₄											152240	161920	179080	204160	223080	
²⁵ / ₃₂													195360	222720	243360	
¹³ / ₁₆													211640	241280	263640	
²⁷ / ₃₂													227920	259840	283920	
⁷ / ₈													244200	278400	304200	
²⁹ / ₃₂														296960	324480	
¹⁵ / ₁₆														301600	329550	
³¹ / ₃₂														338720	370110	
1														371200	405600	
1 ¹ / ₁₆															446160	
1 ¹ / ₈															507000	

Type D Sprockets — Stock Detachable Hubs

Type D sprockets consist of a Type A plate sprocket bolted to a detachable hub. A solid or split plate sprocket may be assembled to a solid or split hub. When ordering a Type D sprocket, be sure to select a plate sprocket large enough to allow chain clearance over the hub flange diameter, dimension D.

Bolt holes of Type D hubs are drilled for interchangeability. Speed ratios may be changed simply by removing the plate sprocket and substituting another with a different number of teeth. When worn, the sprocket may be reversed to use the unworn tooth surfaces, increasing the life of the sprocket.

Split Hubs-Cast Iron — Dimensions (Inches)

Hub Number	Bore Range A		Hub Diameter B	Bolt Circle C	Flange Diameter D	Bolt Holes		E	F	L	Wt. Lbs.
	Stock	*Maximum				Number	Bolt Size				
102S	1 ¹ / ₁₆	1 ¹ / ₂	3	4	5	4	7 ¹ / ₁₆	1 ¹ / ₄	1 ¹ / ₂	3 ¹ / ₂	7.7
103S	1 ¹ / ₈	2 ¹ / ₄	4	5 ¹ / ₁₆	6	4	1/2	2	1 ¹ / ₂	3 ¹ / ₂	14.5
104S	2 ¹ / ₁₆	2 ¹ / ₂	4 ¹ / ₂	5 ¹ / ₂	7	4	5/8	2 ¹ / ₄	1 ¹ / ₄	4	18.3
105S	2 ¹ / ₈	2 ³ / ₄	5	6 ¹ / ₄	7 ¹ / ₂	4	5/8	2 ¹ / ₄	1 ¹ / ₄	4 ¹ / ₂	23.6
106S	2 ¹ / ₄	3 ¹ / ₄	5 ¹ / ₂	7	8 ¹ / ₂	4	5/8	2 ¹ / ₂	2	4 ¹ / ₂	28.2
107S	3 ¹ / ₁₆	3 ¹ / ₂	6	7 ¹ / ₂	9	4	5/8	3	1 ¹ / ₄	4 ¹ / ₂	37.4
108S	3 ¹ / ₈	4	7	8 ¹ / ₂	10 ¹ / ₂	4	5/8	3 ¹ / ₂	1 ¹ / ₄	5 ¹ / ₂	55.1
109S	4 ¹ / ₁₆	6	10 ¹ / ₂	13	15 ¹ / ₂	4	1	4 ¹ / ₂	1 ¹ / ₄	5 ¹ / ₂	155.0

*Maximum bores shown are maximum bores with standard keyseat and setscrew.

To obtain the price of a complete Type D sprocket, add the list price of hub, plus alteration charges and the list price of the desired Type A plate sprocket, including rebore, bolt hole drilling, and splitting charge if desired. These hubs may also be used with Accu-Torch Sprockets.

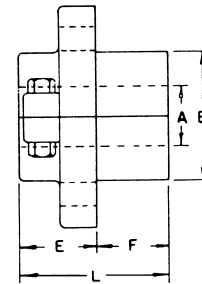
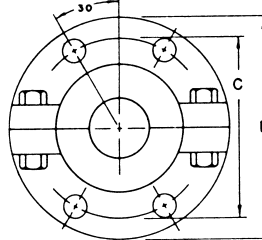
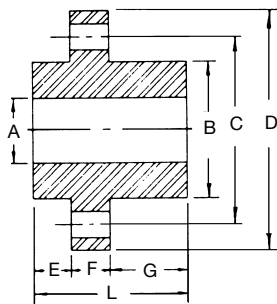

Alteration Charges

See current discount sheet for alteration charges.

Solid Hubs-Steel — Dimensions (Inches)

Hub Number	Bore Range A		Hub Diameter B	Bolt Circle C	Flange Diameter D	Bolt Holes		E	F	G	L	Wt. Lbs.
	Stock	*Maximum				Number	Bolt Size					
101	5/8	1 ¹ / ₄	2 ¹ / ₂	3 ³ / ₈	4 ¹ / ₄	6	5/8	1/2	5/8	1 ¹ / ₄	2	3.4
102	1 ¹ / ₁₆	2	3	4	5	6	7 ¹ / ₁₆	1/2	1/2	1 ¹ / ₂	2 ¹ / ₂	5.4
103	1 ¹ / ₈	2 ¹ / ₂	4	5 ¹ / ₁₆	6	6	1/2	1/2	5/8	1 ¹ / ₂	2 ³ / ₄	10.2
104	2 ¹ / ₁₆	3	4 ¹ / ₂	5 ¹ / ₂	7	6	5/8	1/2	3/4	2	3 ¹ / ₄	14.2
105	2 ¹ / ₈	3 ¹ / ₄	5	6 ¹ / ₄	7 ¹ / ₂	6	5/8	5/8	1 ¹ / ₁₆	2 ¹ / ₂	4	22.2
106	2 ³ / ₁₆	3 ¹ / ₄	5 ¹ / ₂	7	8 ¹ / ₂	6	5/8	5/8	1	2 ¹ / ₂	4	28.4
107	3 ¹ / ₁₆	4	6	7 ¹ / ₂	9	6	5/8	5/8	1 ¹ / ₄	2 ¹ / ₂	4 ¹ / ₂	34.7
108	3 ¹ / ₈	4 ¹ / ₂	7	8 ¹ / ₂	10 ¹ / ₂	6	5/8	5/8	1 ¹ / ₂	2 ¹ / ₂	4 ¹ / ₂	52.4
109	4 ¹ / ₁₆	7	10 ¹ / ₂	13	15 ¹ / ₂	6	1	3/4	1 ¹ / ₂	2 ¹ / ₂	5	143.0

*Maximum bores shown are maximum bores with standard keyseat and setscrew.

All Steel Instant Split[®] Sprocket



Manufactured from stock plate sprockets, *Martin's* Instant Split-Sprocket offers unlimited design and is simply installed with a hand wrench . . . greatly reducing costly downtime.



Single-Style B and C — Steel-Instant Split-Sprocket

Hub Number	Bore	Hub O.D.	Hub* Length	Bolts	Wt. Lbs.
S-1	3/4"-1 1/2"	3 1/2"	1"	3/8" x 2 1/2"	1.8
S-2	1 1/8"-2 1/4"	4 3/8"	1 1/4"	1/2" x 3"	4.1
S-3	2"-3"	6"	1 1/2"	5/8" x 4 1/2"	8.4
S-4	2 3/4"-4"	7 5/8"	1 1/2"	3/4" x 5 1/2"	14.4
S-5	3 3/4"-5"	9 1/4"	2"	1" x 6"	27.8
S-6	4 3/4"-6"	10 1/4"	2 1/4"	1" x 6"	35.4
S-7	5 3/4"-7"	12 1/2"	2 1/2"	1" x 7"	64.4
S-8	6 1/4"-8"	14 1/2"	3"	1" x 8"	98.5

*Add hub length to plate thickness to determine length thru bore.

For style C, add hub length x 2.

SPROCKETS

TOTAL LIST PRICE OF *Martin* SPLIT-SPROCKET IS SIMPLY THE HUB PRICE PLUS THE PLATE PRICE.

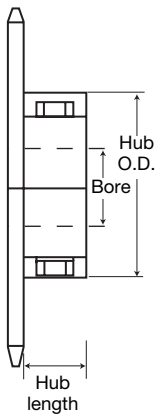

PRICING EXAMPLE STYLE B

**120B45 Split with S-3 Hub,
2 15/16" Bore, KW & SS**

**S-3 Hub
120A45 Plate**

SEE HUB LIST
+ SEE PLATE LIST
TOTAL LIST PRICE

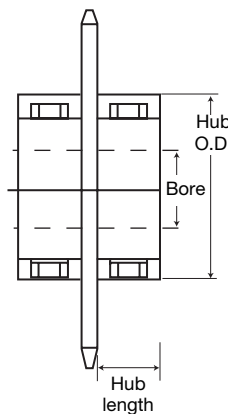

PRICING EXAMPLE STYLE C

**120C45 Split with S-3 Hubs,
2 15/16" Bore, KW & SS**

**Two S-3 Hubs
120A45 Plate**

SEE HUB LIST
+ SEE PLATE LIST
TOTAL LIST PRICE

Instant Split Hubs are for use with plate sprockets only. For multiple strand split sprockets, consult *Martin*.

Sprocket Size For Instant Split Hubs

Split Hub No.	Bore	Minimum Number of Teeth for Single Sprockets										
		Chain Number										
		40	50	60	80	100	120	140	160	180	200	240
S-1	3/4"-1 1/2"	28	23	20	16	—	—	—	—	—	—	—
S-2	1 1/8"-2 1/4"	38	30	26	20	17	15	14	—	—	—	—
S-3	2"-3"	46	37	32	25	20	18	16	15	14	—	—
S-4	2 3/4"-4"	—	48	40	30	25	21	19	17	16	15	12
S-5	3 3/4"-5"	—	—	—	—	30	25	22	20	18	17	14
S-6	4 3/4"-6"	—	—	—	—	32	27	24	22	19	18	15
S-7	5 3/4"-7"	—	—	—	—	—	32	28	25	22	21	18
S-8	6 1/4"-8"	—	—	—	—	—	—	—	28	25	23	20

Martin TORQUE-LIMITER clutch offers thrifty overload protection that's easy to adjust.



Here is low cost protection for your machinery . . . a torque limiting clutch that is easy to install.

Torque-Limiter clutches feature an exclusive "Easy-Set Adjustment." With "Easy-Set," torque adjustment is accomplished quickly! The need for hammer and block, brute strength, and spanner wrenches is eliminated.

These simple steps and the job is done:

1. Snug up the adjusting nut, finger tight, locate set screw over nearest spline notch, and tighten. See table at right.
2. Tighten three cap screws until heads bottom — with a small wrench; this gives maximum torque.
3. For less torque — back off the cap screws, loosen the set screw, back off adjusting nut to one of the six spline notches as required, and retighten set screw and cap screws.

"Easy-Set Adjustment" not only simplifies installation, it provides solid support for pressure plates by compression at their peripheries.

The Torque-Limiter clutch gives machinery permanent protection against overloads during starting, reversing, or driving — by slipping at any desired load. It resumes driving without resetting when the overload is relieved. It is simple in design, compact, efficient, and built for long life. It provides low cost torque limiting service for a wide variety of applications. No lubrication . . . minimum maintenance.

Starting shock from electric motors is a major cause of maintenance of moving parts. Torque-Limiter clutches provide a cushion by slipping until the torque drops to a pre-set level. They can be set to reduce shock loads on motors and driven equipment during reversing or inching. They provide mechanical protection against breakage due to sudden overload — by slipping when the pre-set torque limit is reached.

Torque-Limiter clutches may be used with a sprocket, gear, sheave, flange, or other driven member. It is recommended that the rubbing sides of the driven member be ground to provide a smooth rubbing surface of 63 to 125 micro-inches. See torque rating table on following page.

The driven member is mounted on an oil-impregnated bushing and clamped between two, high quality friction discs by spring pressure. Each Torque-Limiter unit, completely assembled, contains one spring. Higher torque ratings can be obtained by the use of a second spring nested within the original spring. See rating table on following page.

When an overload occurs, the driven member slips between long-life, clutch-type friction discs. After slipping has started, it will continue at approximately 90% of the torque setting, due to the lower coefficient of friction when slipping, until the overload condition has been corrected.

TORQUE-LIMITER CLUTCH CALIBRATION

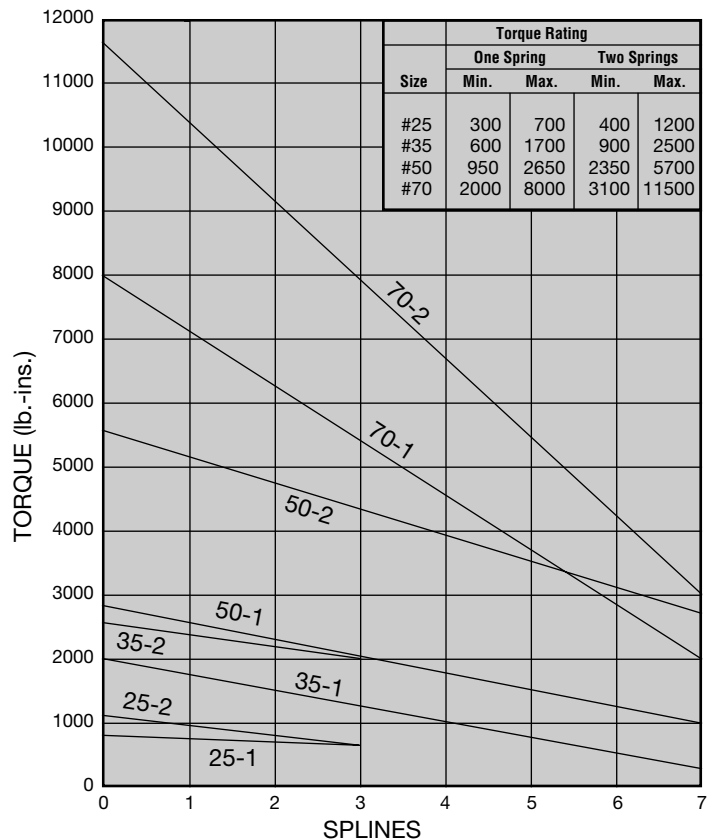

Note:

Graph indicates approximate rated torque vs number of splines adjusting nut is backed off from finger tight.

Torque-Limiter Clutches



TORQUE-LIMITER CLUTCHES



Each assembled unit contains one spring. Higher ratings can be obtained by ordering a second spring to nest in the original one. Bushings need to be ordered separately, if required.

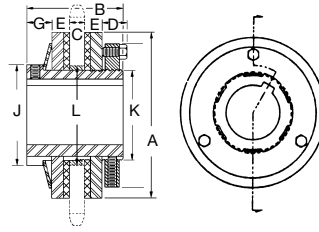

The rubbing sides of the center member should be ground parallel — 63 to 125 micro-inches.

Torque-Limiter Clutch Ratings

Size No.	Avg. Wt.	Torque Rating ▲ (Pound-Inches)				C										K +.000 - .002 Spline O. D.	L +.003 - .000 Spt. Bore
		With One Spring		With Two Springs**		A	B	Min.		D	E	G	H	J			
		Min.	Max.	Min.	Max.			1/2	3/4								
TT25	1	300	700	400	1200	2 1/2	1 3/4	1/2	3/4	1/2	3/4	1/2	3/4	1 1/2	1.368	1.631/1.628	
TT35	2.5	600	1700	900	2500	3 1/2	2 3/4	1/2	3/4	5/8	3/4	1/2	3/4	1 5/8	1.675	2.006/2.003	
TT50	6	950	2650	2350	5700	5	2 3/4	1/2	3/4	3/4	1/2	3/4	1 1/2	2.625	3.008/3.005		
TT70	18	2100	8000	3100	11500	7	3 3/4	1/2	3/4	1 1/4	1 1/4	1 1/2	2	3.811	4.197/4.194		

▲ Using a center member with rubbing sides ground parallel — 63 to 125 micro-inches. Center member must be clean and free from oil, rust, etc.

** Second spring may be nested in one originally furnished. Order if required.

◆ Nominal for maximum torque setting. For minimum torque setting, add 3/8" for No. 25; 1/2" for Nos. 35 and 50. When two springs are used this dimension is increased approximately 1/16" on Nos. 25, 35 and 50 — 3/32" on No. 70.

Stock Bores — Torque Limiters (No KW 1-SS†)

Size No.	Stock Bore	Max. Bore	
		Std. KW*	Shallow KW*
TT25	1/2	3/8	1
TT35	3/4	1 1/8	1 1/4
TT50	1	1 1/4	2
TT70	1 1/2	2 1/4	3

† Additional SS See List Price Alterations

* KW To Be Cut Central w/Threaded Spline

Standard Keyways

Torque-Limiter Bore	Keyway	Torque-Limiter Bore	Keyway
1/2-3/8	1/8 x 1/16	1 1/8-1 1/4	3/8 x 3/16
3/8-1/2	3/16 x 3/32	1 1/4-2 1/4	1/2 x 1/4
1/2-1 1/4	1/4 x 1/8	2 1/4-2 3/4	5/8 x 5/16
1 1/8-1 1/2	5/16 x 3/32	2 3/4-3	3/4 x 3/8

Bored to Size Torque Limiters w/Std. KW & 1-SS†

Size No.	Finished Bores											
	1/2	3/4	1	1 1/4	1 1/2	1 3/4	2	2 1/4	2 1/2	2 3/4	3	3 1/2
TT25												
TT35			1									
TT50			1	1 1/2	1 3/4	2	2 1/4	2 1/2	2 3/4	3	3 1/2	3 3/4
TT70								1 1/2	1 3/4	2	2 1/4	2 1/2

† KW Same as Std. Listed in Tables Above. Additional S.S. See List Price

Unit Size	Min. Allowable Sprocket Teeth and Length of Bushing Req'd for Chain Number											
	Sprocket Pitch	35	41	40	50	60	80	100	120	140	160	
TT25	Min. Teeth	STK. ★	25	19	19	16	
		MTO ●	25	19	19	16	
	Bush. Lght. Req'd.		1/2	1/2	1/4	1/4	
TT35	Min. Teeth	STK. ★	35	25	26	21	18	15	
		MTO ●	33	25	26	21	18	15	
	Bush. Lght. Req'd.		1/2	1/2	1/4	1/4	3/8	3/8	
TT50	Min. Teeth	STK. ★	48	35	35	29	25	19	
		MTO ●	46	35	35	29	25	19	
	Bush. Lght. Req'd.		1/2	1/2	1/4	1/4	3/8	3/8	
TT70	Min. Teeth	STK. ★	48	38	33	26	21	18	16	14
		MTO ●	48	38	33	26	21	18	16	14
	Bush. Lght. Req'd.		1/4	1/4	3/8	3/8	1/2	1/2	1/2	1 ◆

★ Min. number of teeth on sprocket stocked by Martin which can be used w/Torque-Limiter clutch.

◆ Min. number of teeth on made-to-order sprocket which will permit chain to clear friction disc.

* Use one 3/8" long bushing and one 1/2" long.

◆ Use two 1/2" long bushings.

Stock Plate Sprockets with Ground Face and Bored to Fit the Martin Torque Limiter

UNIT TT25

Sprocket Size
35TTA25-25
35TTA26-25
40TTA20-25
40TTA22-25
40TTA24-25
40TTA28-25
40TTA30-25
50TTA17-25
50TTA21-25
50TTA22-25

UNIT TT35

Sprocket Size
35TTA35-35
35TTA40-35
40TTA28-35
40TTA30-35
40TTA32-35
50TTA22-35
50TTA24-35
50TTA25-35
50TTA26-35
60TTA18-35
60TTA20-35

UNIT TT50

Sprocket Size
40TTA35-50
50TTA30-50
50TTA32-50
60TTA25-50
60TTA26-50
60TTA28-50
60TTA30-50
80TTA20-50
80TTA22-50
80TTA24-50

UNIT TT70

Sprocket Size
60TTA36-70
80TTA26-70
80TTA28-70
80TTA30-70
80TTA36-70
100TTA22-70
100TTA24-70

SPARE PARTS

TT25 TT50 TT35 TT70	QTY. REQ. *
PRESSURE PLATE	2
FRICTION DISC	2
ADJ. NUT ASSY. & S.S.	1
ADJ. TENSION NUT	3
HUB	1

* PER UNIT





**Standard Roller
Double Duty**



**Carrier
Roller**

Double-Pitch Sprockets

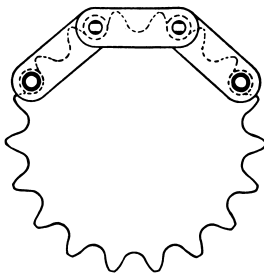

Standard Rollers

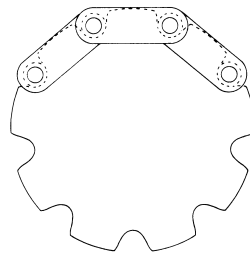

**Double Pitch
Single Duty
Made-To-Order**

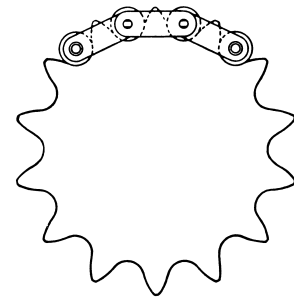

Carrier Rollers

Series C-2000 chains have rollers of the same diameters and widths as American Standard Roller Chains of one half the conveyor chain pitch. Engaged by every other tooth, double duty sprockets have two teeth per chain pitch. During each revolution only half the teeth function effectively. Sprockets with odd numbers of teeth will allow any given tooth to engage only on every other revolution, automatically increasing sprocket life. Double duty sprockets with even number of teeth may be manually advanced one tooth periodically to increase sprocket life. *Martin* Stock C-2000 series sprockets are furnished double duty only.

Sprockets for the C-2002 series chain with carrier rollers are cut with space cutters or standard hobs for the American Standard roller Chain of the same diameter. Each sprocket tooth meshes with these chains. Double-duty sprockets cannot be made for double pitch chain with Carrier Rollers.

NOTE: For drives of 31 teeth or more we recommend using Standard sprockets with series C-2000 chains.

All altered double pitch sprockets requiring a keyway will be furnished with keyway on center line of tooth, unless otherwise specified.

Double Pitch All Steel Stock Sprockets

1-Inch Double-Pitch

Conveyor or Drive Series — Standard Roller Double Pitch — 2040/C2040

No. Teeth Actual	Eff. No. Teeth	Outside Diameter	Pitch Diameter	Catalog Number	Type	Bore		Hub		Wt. Lbs. (Approx.)
						Stock	Rec. Max.	Diameter	Length Thru	
11	5.5	2.000	1.852	2040B11	B	1/2	13/16	1 1/8*	3/8	.34
12	6	2.170	2.000	2040B12	B	1/2	13/16	1 1/8*	3/8	.44
13	6.5	2.330	2.152	2040B13	B	1/2	21/32	1 1/8*	3/8	.48
14	7	2.490	2.305	2040B14	B	1/2	1 1/2	1 1/8*	3/8	.60
15	7.5	2.650	2.458	2040B15	B	5/8	1 1/2	1 3/8	3/8	.66
16	8	2.810	2.613	2040B16	B	5/8	1 3/2	1 1/8	3/8	.76
17	8.5	2.980	2.768	2040B17	B	5/8	1 1/2	2 5/16	1	1.00
18	9	3.140	2.924	2040B18	B	5/8	1 13/32	2 1/2	1	1.16
19	9.5	3.300	3.080	2040B19	B	5/8	1 1/2	2 3/8	1	1.36
20	10	3.460	3.236	2040B20	B	5/8	1 1/2	2 5/8	1	1.54
21	10.5	3.620	3.392	2040B21	B	5/8	1 3/2	2 3/4	1	1.74
22	11	3.780	3.549	2040B22	B	5/8	1 1/2	2 1/2	1	1.92
23	11.5	3.940	3.706	2040B23	B	5/8	2	3	1	2.16
24	12	4.100	3.864	2040B24	B	5/8	2 1/4	3 1/4	1	2.44
25	12.5	4.260	4.021	2040B25	B	5/8	2 1/4	3 1/4	1	2.48
26	13	4.420	4.179	2040B26	B	5/8	2 1/4	3 1/4	1	2.60
28	14	4.740	4.494	2040B28	B	5/8	2 1/4	3 1/4	1	2.74
30	15	5.060	4.810	2040B30	B	5/8	2 1/4	3 1/4	1	2.92

★ Has recessed groove in hub for chain clearance.

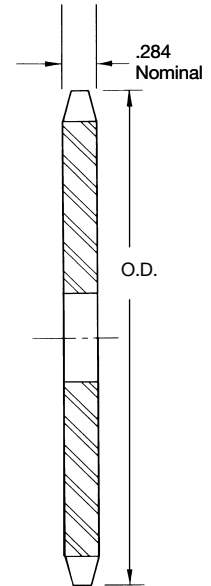

TYPE A

Conveyor Series — Carrier Roller Double Pitch — 2042/C2042

No. Teeth Actual	Outside Diameter	Pitch Diameter	Catalog Number	Type	Bore		Hub		Wt. Lbs. (Approx.)	Type	Catalog Number	Stock Bore	Wt. Lbs. (Approx.)
					Stock	Rec. Max.	Dia.	Length Thru					
8	3.010	2.613	2042B8	B	5/8	1 1/2	1 1/8	3/8	.72				
9	3.350	2.924	2042B9	B	5/8	1 13/32	2 1/32	3/8	1.02				
10	3.680	3.236	2042B10	B	5/8	1 1/4	2 5/16	1	1.50				
11	4.000	3.549	2042B11	B	5/8	1 1/8	2 1/2	1	1.68				
12	4.330	3.864	2042B12	B	5/8	2 1/4	3 1/16	1	2.22				
13	4.660	4.179	2042B13	B	5/8	2 1/4	3 1/4	1	2.56				
14	4.980	4.494	2042B14	B	5/8	2 1/4	3 1/4	1	2.72				
15	5.300	4.810	2042B15	B	5/8	2 1/4	3 1/4	1	2.90				
16	5.630	5.126	2042B16	B	5/8	2 1/4	3 1/4	1	3.10	A	2042A16	19/32	1.38
17	5.950	5.442	2042B17	B	5/8	2 1/4	3 1/4	1	3.40	A	2042A17	19/32	1.66
18	6.270	5.759	2042B18	B	5/8	2 1/4	3 1/4	1	3.56	A	2042A18	19/32	1.88
19	6.590	6.076	2042B19	B	5/8	2 1/4	3 1/4	1	3.72	A	2042A19	19/32	2.06
20	6.910	6.392	2042B20	B	5/8	2 3/4	3 1/2	1 1/8	4.72	A	2042A20	23/32	2.40
21	7.240	6.710	2042B21	B	5/8	2 3/4	3 1/2	1 1/8	4.84	A	2042A21	23/32	2.62
22	7.560	7.027	2042B22	B	5/8	2 3/4	3 1/2	1 1/8	5.18	A	2042A22	23/32	2.88
23	7.880	7.344	2042B23	B	5/8	2 3/4	3 1/2	1 1/8	5.04	A	2042A23	23/32	3.14
24	8.200	7.661	2042B24	B	5/8	2 3/4	3 1/2	1 1/8	5.58	A	2042A24	23/32	3.22
25	8.520	7.979	2042B25	B	5/8	2 3/4	3 1/2	1 1/8	5.96	A	2042A25	23/32	3.50
26	8.840	8.296	2042B26	B	5/8	2 3/4	3 1/2	1 1/8	6.22	A	2042A26	23/32	3.74
28	9.480	8.931	2042B28	B	5/8	2 3/4	3 1/2	1 1/8	6.78	A	2042A28	23/32	4.76
30	10.110	9.567	2042B30	B	5/8	2 3/4	3 1/2	1 1/8	7.56	A	2042A30	23/32	5.08

★ Has recessed groove in hub for chain clearance.

Maximum bores shown will accommodate standard keyseat and setscrew over keyseat.
Slightly larger bores are possible with no keyseat, shallow keyseat, or setscrew at angle to keyseat.

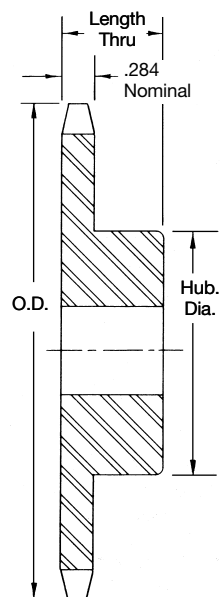

TYPE B

1/4-Inch Double-Pitch

Conveyor or Drive Series — Standard Roller Double Pitch — 2050/C2050

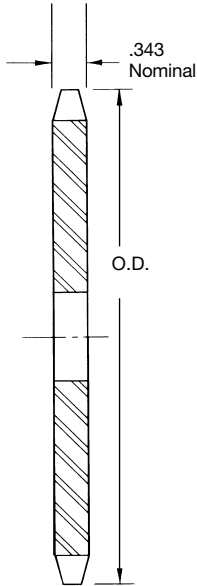

TYPE A

No. Teeth Actual	Eff. No. Teeth	Outside Diameter	Pitch Diameter	Catalog Number	Type	Bore		Hub		Wt. Lbs. (Approx.)	Type	Catalog Number	Stock Bore	Wt. Lbs. (Approx.)
						Stock	Rec. Max.	Dia.	Length Thru					
11	5.5	2.500	2.315	2050B11	B	5/8	1/16	1 1/4*	1	.62				
12	6	2.710	2.500	2050B12	B	5/8	1	1 5/8	1	.80				
13	6.5	2.910	2.690	2050B13	B	5/8	1 1/32	1 29/32	1	.82				
14	7	3.110	2.881	2050B14	B	5/8	1 1/2	1 1/16	1	1.00				
15	7.5	3.320	3.073	2050B15	B	5/8	1 1/32	2 29/32	1	1.22				
16	8	3.520	3.266	2050B16	B	5/8	1 1/32	2 3/4	1	1.44				
17	8.5	3.720	3.460	2050B17	B	5/8	1 1/4	2 1/16	1	1.68				
18	9	3.920	3.655	2050B18	B	5/8	1 29/32	2 5/32	1	1.94				
19	9.5	4.120	3.850	2050B19	B	5/8	1 3/32	2 3/4	1	2.24				
20	10	4.320	4.045	2050B20	B	3/4	2	3	1	2.30				
21	10.5	4.520	4.241	2050B21	B	3/4	2	3	1	2.40				
22	11	4.720	4.437	2050B22	B	3/4	2	3	1	2.54				
23	11.5	4.920	4.633	2050B23	B	3/4	2	3	1	2.66				
24	12	5.120	4.830	2050B24	B	3/4	2	3	1 1/4	3.30	A	2050A24	29/32	1.58
25	12.5	5.320	5.026	2050B25	B	3/4	2	3	1 1/4	3.42	A	2050A25	29/32	1.68
26	13	5.520	5.223	2050B26	B	3/4	2	3	1 1/4	3.62	A	2050A26	29/32	1.88
28	14	5.920	5.617	2050B28	B	3/4	2	3	1 1/4	3.78	A	2050A28	29/32	2.22
30	15	6.320	6.012	2050B30	B	3/4	2 1/4	3 1/4	1 1/4	4.58	A	2050A30	29/32	2.54

* Has recessed groove in hub for chain clearance.

Conveyor Series — Carrier Roller Double Pitch — 2052/C2052

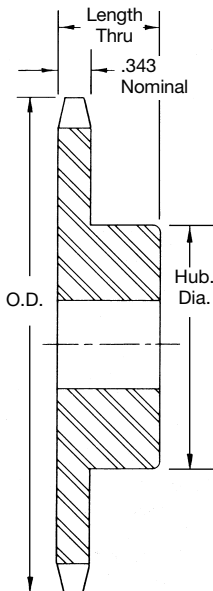

TYPE B

No. Teeth Actual	Outside Diameter	Pitch Diameter	Catalog Number	Type	Bore		Hub		Wt. Lbs. (Approx.)	Type	Catalog Number	Stock Bore	Wt. Lbs. (Approx.)
					Stock	Rec. Max.	Dia.	Length Thru					
8	3.770	3.266	2052B8	B	5/8	1 1/32	2 29/64	1	1.38				
9	4.190	3.655	2052B9	B	5/8	1 29/32	2 29/32	1	1.92				
10	4.600	4.045	2052B10	B	5/8	2	3	1	2.30				
11	5.010	4.437	2052B11	B	5/8	2	3	1	2.54				
12	5.420	4.830	2052B12	B	3/4	2	3	1 1/4	3.20	A	2052A12	29/32	1.58
13	5.820	5.223	2052B13	B	3/4	2	3	1 1/4	3.48	A	2052A13	29/32	1.82
14	6.230	5.617	2052B14	B	3/4	2	3	1 1/4	3.88	A	2052A14	29/32	2.28
15	6.630	6.012	2052B15	B	3/4	2 1/4	3 1/4	1 1/4	4.46	A	2052A15	29/32	2.46
16	7.030	6.407	2052B16	B	3/4	2 1/4	3 1/4	1 1/4	4.80	A	2052A16	29/32	2.88
17	7.440	6.803	2052B17	B	3/4	2 1/4	3 1/4	1 1/4	5.34	A	2052A17	29/32	3.28
18	7.840	7.198	2052B18	B	3/4	2 1/4	3 1/4	1 1/4	5.64	A	2052A18	29/32	3.64
19	8.240	7.595	2052B19	B	3/4	2 1/4	3 1/4	1 1/4	6.04	A	2052A19	29/32	4.12
20	8.640	7.991	2052B20	B	3/4	2 1/4	3 1/4	1 1/4	6.48	A	2052A20	29/32	4.72
21	9.040	8.387	2052B21	B	3/4	2 1/4	3 1/4	1 1/4	7.00	A	2052A21	29/32	5.08
22	9.440	8.783	2052B22	B	3/4	2 1/4	3 1/4	1 1/4	7.30	A	2052A22	29/32	5.20
23	9.850	9.180	2052B23	B	1	2 3/4	3 3/4	1 1/4	8.66	A	2052A23	15/16	5.84
24	10.250	9.577	2052B24	B	15/16	2 3/4	3 3/4	1 1/4	9.32	A	2052A24	15/16	6.70
25	10.650	9.973	2052B25	B	15/16	2 3/4	3 3/4	1 1/4	10.30	A	2052A25	15/16	7.54
26	11.050	10.370	2052B26	B	15/16	2 3/4	3 3/4	1 1/4	11.00	A	2052A26	15/16	8.24
28	11.840	11.164	2052B28	B	15/16	2 3/4	3 3/4	1 1/4	11.70	A	2052A28	15/16	8.70
30	12.640	11.958	2052B30	B	15/16	2 3/4	3 3/4	1 1/4	12.90	A	2052A30	15/16	9.92

* Has recessed groove in hub for chain clearance.

Maximum bores shown will accommodate standard keyseat and setscrew over keyseat. Slightly larger bores are possible with no keyseat, shallow keyseat, or setscrew at angle to keyseat.

SPROCKETS

Double Pitch All Steel Stock Sprockets

1½-Inch Double-Pitch

Conveyor Series — Standard Roller Double Pitch — 2060/C2060

No. Teeth Actual	Eff. No. Teeth	Outside Diameter	Pitch Diameter	Catalog Number	Type	Bore		Hub		Wt. Lbs. (Approx.)	Type	Catalog Number	Stock Bore	Wt. Lbs. (Approx.)
						Stock	Rec. Max.	Dia.	Length Thru					
11	5.5	3.000	2.773	2060B11	B	3/8	1	2 1/16*	1 1/4	1.14				
12	6	3.250	3.000	2060B12	B	3/8	1 1/4	2 3/16*	1 1/4	1.46				
13	6.5	3.490	3.228	2060B13	B	3/8	1 1/8	2 3/64	1 1/4	1.52				
14	7	3.740	3.457	2060B14	B	3/8	1 1/8	2 3/64	1 1/4	1.86				
15	7.5	3.980	3.688	2060B15	B	3/8	1 1/4	2 19/32	1 1/4	2.24				
16	8	4.220	3.920	2060B16	B	3/8	1 7/32	2 27/32	1 1/4	2.64				
17	8.5	4.460	4.152	2060B17	B	3/8	2 3/32	3 3/32	1 1/4	3.08				
18	9	4.700	4.386	2060B18	B	3/8	2 3/32	3 11/32	1 1/4	3.56				
19	9.5	4.940	4.620	2060B19	B	3/8	2 11/32	3 1/2	1 1/4	3.94				
20	10	5.190	4.854	2060B20	B	3/8	2 9/16	3 7/8	1 1/4	4.50				
21	10.5	5.430	5.089	2060B21	B	3/8	2 3/4	4	1 1/4	5.02				
22	11	5.670	5.324	2060B22	B	3/8	2 3/4	4	1 1/4	5.26				
23	11.5	5.910	5.560	2060B23	B	3/8	2 3/4	4	1 1/4	5.54				
24	12	6.150	5.796	2060B24	B	3/8	2 3/4	4	1 1/4	5.90	A	2060A24	23/32	3.02
25	12.5	6.390	6.032	2060B25	B	3/8	2 3/4	4	1 1/4	6.08	A	2060A25	23/32	3.36
26	13	6.630	6.268	2060B26	B	3/8	2 3/4	4	1 1/4	6.36	A	2060A26	23/32	3.58
28	14	7.110	6.741	2060B28	B	3/8	2 3/4	4	1 1/4	7.02	A	2060A28	23/32	4.12
30	15	7.590	7.215	2060B30	B	3/8	2 3/4	4	1 1/4	7.54	A	2060A30	23/32	4.88

* Has recessed groove in hub for chain clearance.

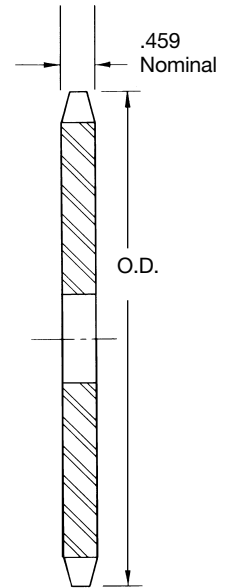

TYPE A

Conveyor Series — Carrier Roller Double Pitch — 2062/C2062

No. Teeth Actual	Outside Diameter	Pitch Diameter	Catalog Number	Type	Bore		Hub		Wt. Lbs. (Approx.)	Type	Catalog Number	Stock Bore	Wt. Lbs. (Approx.)
					Stock	Rec. Max.	Dia.	Length Thru					
8	4.520	3.920	2062B8	B	3/8	1 7/32	2 27/32	1 1/4	2.60				
9	5.020	4.386	2062B9	B	3/8	2 3/32	3 11/32	1 1/4	3.48				
10	5.520	4.854	2062B10	B	3/8	2 1/16	3 39/64	1 1/4	4.54				
11	6.010	5.324	2062B11	B	3/8	2 3/4	4	1 1/4	5.20				
12	6.500	5.796	2062B12	B	3/8	2 3/4	4	1 1/4	5.70	A	2062A12	23/32	2.98
13	6.990	6.268	2062B13	B	3/8	2 3/4	4	1 1/4	6.28	A	2062A13	23/32	3.60
14	7.470	6.741	2062B14	B	3/8	2 3/4	4	1 1/4	6.82	A	2062A14	23/32	4.02
15	7.960	7.215	2062B15	B	3/8	2 3/4	4	1 1/4	7.48	A	2062A15	23/32	4.76
16	8.440	7.689	2062B16	B	3/8	2 3/4	4	1 1/4	8.18	A	2062A16	23/32	5.70
17	8.920	8.163	2062B17	B	1	2 3/4	4	1 1/4	8.82	A	2062A17	15/16	6.16
18	9.410	8.638	2062B18	B	1	2 3/4	4	1 1/4	9.36	A	2062A18	15/16	6.96
19	9.890	9.113	2062B19	B	1	2 3/4	4 1/4	1 1/4	11.10	A	2062A19	15/16	8.00
20	10.370	9.589	2062B20	B	15/16	2 3/4	4 1/4	1 1/4	11.66	A	2062A20	15/16	8.46
21	10.850	10.064	2062B21	B	15/16	2 3/4	4 1/4	1 1/4	13.24	A	2062A21	15/16	8.93
22	11.330	10.540	2062B22	B	15/16	2 3/4	4 1/4	1 1/4	13.78	A	2062A22	15/16	10.74
23	11.810	11.016	2062B23	B	15/16	2 3/4	4 1/4	1 1/4	14.90	A	2062A23	15/16	11.64
24	12.290	11.492	2062B24	B	15/16	2 3/4	4 1/4	1 1/4	15.66	A	2062A24	15/16	12.64
25	12.770	11.968	2062B25	B	15/16	2 3/4	4 1/4	1 1/4	16.80	A	2062A25	15/16	13.78
26	13.250	12.444	2062B26	B	15/16	2 3/4	4 1/4	1 1/4	20.20	A	2062A26	15/16	15.00
28	14.210	13.397	2062B28	B	1 1/4	2 3/4	4 1/4	1 1/4	21.86	A	2062A28	1 1/4	17.32
30	15.170	14.350	2062B30	B	1 1/4	2 3/4	4 1/4	1 1/4	26.00	A	2062A30	1 1/4	19.50

* Has recessed groove in hub for chain clearance.

Maximum bores shown will accommodate standard keyseat and setscrew over keyseat.
Slightly larger bores are possible with no keyseat, shallow keyseat, or setscrew at angle to keyseat.

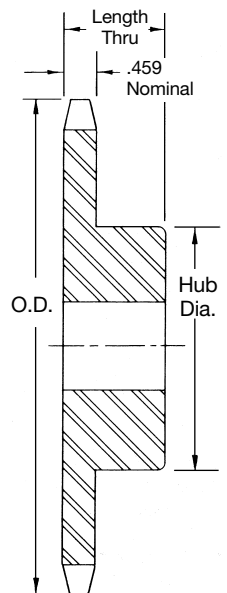

TYPE B

SPROCKETS

2-Inch Double-Pitch

Conveyor or Drive Series — Standard Roller Double Pitch — 2080/C2080

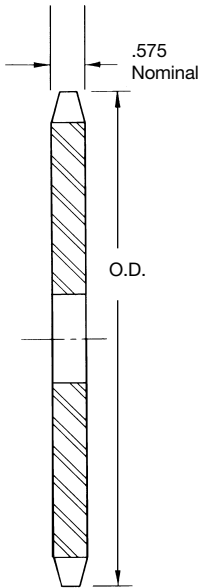

TYPE A

No. Teeth Actual	Eff. No. Teeth	Outside Diameter	Pitch Diameter	Catalog Number	Type	Bore		Hub		Wt. Lbs. (Approx.)	Type	Catalog Number	Stock Bore	Wt. Lbs. (Approx.)
						Stock	Rec. Max.	Dia.	Length Thru					
11	5.5	4.010	3.694	2080B11	B	1	1 1/2	2 3/16*	1 1/2	2.5				
12	6	4.330	4.000	2080B12	B	1	1 1/16	3 3/16*	1 1/2	3.2				
13	6.5	4.660	4.304	2080B13	B	1	1 5/16	2 5/8	1 1/2	3.3				
14	7	4.980	4.610	2080B14	B	1	2 1/8	3 1/8	1 1/2	4.0				
15	7.5	5.300	4.917	2080B15	B	1	2 3/16	3 3/16	1 1/2	4.8				
16	8	5.630	5.226	2080B16	B	1	2 1/8	3 5/16	1 1/2	5.7				
17	8.5	5.950	5.536	2080B17	B	1	2 3/8	4	1 1/2	6.4	A	2080A17	1 5/16	3.4
18	9	6.270	5.848	2080B18	B	1	2 3/4	4 1/4	1 1/2	7.4	A	2080A18	1 5/16	3.8
19	9.5	6.590	6.160	2080B19	B	1	2 7/8	4 1/2	1 1/2	7.7	A	2080A19	1 5/16	4.3
20	10	6.910	6.472	2080B20	B	1	2 7/8	4 1/2	1 1/2	8.3	A	2080A20	1 5/16	4.8
21	10.5	7.230	6.785	2080B21	B	1	2 7/8	4 1/2	1 1/2	9.4	A	2080A21	1 5/16	5.3
22	11	7.560	7.099	2080B22	B	1	2 7/8	4 1/2	1 1/2	10.0	A	2080A22	1 5/16	5.8
23	11.5	7.880	7.413	2080B23	B	1	2 7/8	4 1/2	1 1/2	10.5	A	2080A23	1 5/16	6.4
24	12	8.200	7.727	2080B24	B	1	2 7/8	4 1/2	1 1/2	11.1	A	2080A24	1 5/16	7.1
25	12.5	8.520	8.042	2080B25	B	1	2 7/8	4 1/2	1 1/2	12.0	A	2080A25	1 5/16	7.5
26	13	8.840	8.357	2080B26	B	1 1/4	3 1/4	4 3/4	2	14.8	A	2080A26	1 3/16	8.3
28	14	9.480	8.988	2080B28	B	1 3/16	3 3/4	4 3/4	2	16.6	A	2080A28	1 3/16	9.2
30	15	10.110	9.620	2080B30	B	1 3/16	3 3/4	4 3/4	2	17.8	A	2080A30	1 3/16	10.7

* Has recessed groove in hub for chain clearance.

Conveyor Series — Carrier Roller Double Pitch — 2082/C2082

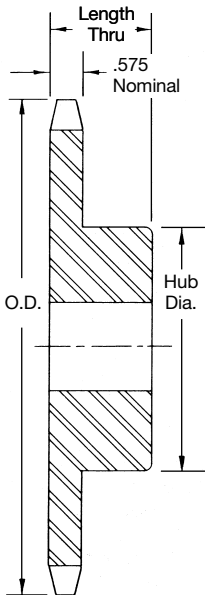

TYPE B

No. Teeth Actual	Outside Diameter	Pitch Diameter	Catalog Number	Type	Bore		Hub		Wt. Lbs. (Approx.)	Type	Catalog Number	Stock Bore	Wt. Lbs. (Approx.)
					Stock	Rec. Max.	Dia.	Length Thru					
8	6.030	5.226	2082B8	B	1	2 1/16	3 5/16	1 1/2	6.4				
9	6.700	5.848	2082B9	B	1	2 3/16	4 1/4	1 1/2	8.2				
10	7.360	6.472	2082B10	B	1	2 3/8	4 1/2	1 1/2	9.2				
11	8.010	7.099	2082B11	B	1	2 3/4	4 3/4	1 1/2	10.1	A	2082A11	1 5/16	5.7
12	8.660	7.727	2082B12	B	1	2 3/4	4 3/4	1 1/2	11.2	A	2082A12	1 5/16	6.8
13	9.310	8.357	2082B13	B	1 1/4	3 1/4	4 3/4	2	15.0	A	2082A13	1 3/16	7.7
14	9.960	8.988	2082B14	B	1 1/4	3 3/4	4 3/4	2	15.8	A	2082A14	1 3/16	9.1
15	10.610	9.620	2082B15	B	1 1/8	3 3/4	4 3/4	2	17.8	A	2082A15	1 3/16	10.7
16	11.250	10.252	2082B16	B	1 3/16	3 3/4	4 3/4	2	19.3	A	2082A16	1 3/16	12.4
17	11.900	10.885	2082B17	B	1 3/16	3 3/4	4 3/4	2	21.4	A	2082A17	1 3/16	14.1
18	12.540	11.518	2082B18	B	1 3/16	3 3/4	4 3/4	2	22.9	A	2082A18	1 3/16	15.4
19	13.190	12.151	2082B19	B	1 3/16	3 3/4	4 3/4	2	24.4	A	2082A19	1 3/16	18.0
20	13.830	12.785	2082B20	B	1 3/16	3 3/4	4 3/4	2	26.7	A	2082A20	1 3/16	19.2
21	14.470	13.419	2082B21	B	1 1/4	3 3/4	4 3/4	2	28.4	A	2082A21	1 1/4	20.8
22	15.110	14.053	2082B22	B	1 1/4	3 3/4	4 3/4	2	39.6	A	2082A22	1 1/4	23.7
23	15.750	14.688	2082B23	B	1 1/4	3 3/4	4 3/4	2	32.2	A	2082A23	1 1/4	24.9
24	16.390	15.323	2082B24	B	1 1/4	3 3/4	4 3/4	2	34.9	A	2082A24	1 1/4	27.6
25	17.030	15.958	2082B25	B	1 1/4	3 3/4	4 3/4	2	37.8	A	2082A25	1 1/4	30.2
26	17.670	16.593	2082B26	B	1 1/4	3 3/2	5 1/4	2	41.5	A	2082A26	1 1/4	32.8
28	18.950	17.863	2082B28	B	1 1/4	3 3/2	5 1/4	2	47.7	A	2082A28	1 1/4	38.6
30	20.230	19.134	2082B30	B	1 1/4	3 3/2	5 1/4	2	54.5	A	2082A30	1 1/4	43.8

* Has recessed groove in hub for chain clearance.

Maximum bores shown will accommodate standard keyseat and setscrew over keyseat.
Slightly larger bores are possible with no keyseat, shallow keyseat, or setscrew at angle to keyseat.

No. 25

1/4" Pitch

All Steel Stock Sprockets

Martin

Single-Type B

Single-Type A

No. Teeth	Catalog Number	Outside Diameter	Type	Bore (inches)		Hub (inches)		Weight Lbs. (Approx.)	Type	Catalog Number	Stock Bore	Weight Lbs. (Approx.)
				Stock	Rec. Max.	Diameter	Length Thru					
9	25B9	.837	B	1/4	1/4	7/16	1/2	.03				
10	25B10	.919	B	1/4	1/4	1/2	1/2	.03				
11	25B11	1.002	B	1/4	5/16	9/16	1/2	.04				
12	25B12	1.083	B	1/4	3/8	5/8	1/2	.06				
13	25B13	1.167	B	1/4	7/16	29/32	1/2	.07				
14	25B14	1.246	B	1/4	9/16	15/16	1/2	.08				
15	25B15	1.326	B	1/4	5/8	57/64	1/2	.10				
16	25B16	1.407	B	1/4	9/16	31/32	1/2	.12				
17	25B17	1.487	B	1/4	3/4	1 1/32	1/2	.14				
18	25B18	1.568	B	1/4	3/4	1 1/8	1/2	.16	A	25A18	1/4	.04
19	25B19	1.648	B	1/4	7/8	1 1/16	1/2	.19	A	25A19	1/4	.04
20	25B20	1.729	B	1/4	7/8	1 1/8	1/2	.25	A	25A20	1/4	.04
21	25B21	1.809	B	1/4	7/8	1 1/8	3/4	.28	A	25A21	3/8	.04
22	25B22	1.889	B	1/4	15/16	1 1/16	3/4	.31	A	25A22	3/8	.06
23	25B23	1.969	B	1/4	1	1 1/8	3/4	.32	A	25A23	3/8	.06
24	25B24	2.049	B	3/8	1	1 1/2	3/4	.33	A	25A24	3/8	.08
25	25B25	2.129	B	3/8	1	1 1/2	3/4	.34	A	25A25	3/8	.08
26	25B26	2.209	B	3/8	1	1 1/2	3/4	.35	A	25A26	3/8	.09
28	25B28	2.369	B	3/8	1	1 1/2	3/4	.36	A	25A28	3/8	.10
30	25B30	2.529	B	3/8	1	1 1/2	3/4	.38	A	25A30	3/8	.12
32	25B32	2.688	B	3/8	1	1 1/2	3/4	.40	A	25A32	3/8	.14
35		2.928							A	25A35	3/8	.16
36	25B36	3.008	B	3/8	1	1 1/2	3/4	.50	A	25A36	3/8	.18
40	25B40	3.327	B	1/2	1 1/8	2	3/4	.53	A	25A40	1/2	.20
42		3.486							A	25A42	1/2	.24
45	25B45	3.725	B	1/2	1 1/8	2	3/4	.56	A	25A45	1/2	.25
48	25B48	3.964	B	1/2	1 1/8	2	3/4	.56	A	25A48	1/2	.32
54	25B54	4.442	B	1/2	1 1/8	2	3/4	1.00	A	25A54	1/2	.38
60	25B60	4.920	B	1/2	1 1/8	2	3/4	1.10	A	25A60	1/2	.54
70	25B70	5.717	B	1/2	1 1/8	2	3/4	1.25				
72	25B72	5.876	B	1/2	1 1/8	2	3/4	1.30	A	25A72	1/2	.74

Maximum bores shown will accommodate standard keyseat and setscrew over keyseat. Slightly larger bores are possible with no keyseat, shallow keyseat, or setscrew at angle to keyseat.

SPROCKETS

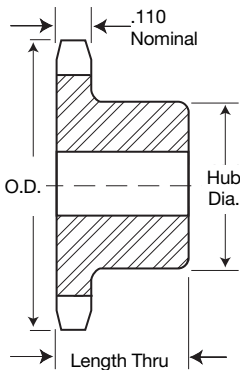

TYPE B



Alteration Charges

See current discount sheet for alteration charges.

Single-Type B — Stainless

No. Teeth	Catalog Number	Outside Diameter	Type	Bore (inches)		Hub (inches)		Weight Lbs. (Approx.)
				Stock	Rec. Max.	Diameter	Length Thru	
9	25B9SS	.837	B	1/4	1/4	7/16	1/2	.03
10	25B10SS	.919	B	1/4	1/4	1/2	1/2	.03
11	25B11SS	1.001	B	1/4	5/16	9/16	1/2	.03
12	25B12SS	1.083	B	1/4	3/8	5/8	1/2	.06
13	25B13SS	1.164	B	1/4	7/16	29/32	1/2	.07
14	25B14SS	1.245	B	1/4	9/16	13/16	1/2	.08
15	25B15SS	1.326	B	1/4	5/16	5/8	1/2	.10
16	25B16SS	1.407	B	1/4	9/16	3/4	1/2	.12
17	25B17SS	1.487	B	1/4	3/8	1 1/32	1/2	.14
18	25B18SS	1.568	B	1/4	3/4	1 1/8	1/2	.16
19	25B19SS	1.648	B	1/4	7/16	1 1/32	1/2	.19
20	25B20SS	1.728	B	1/4	1/2	1 1/32	5/8	.25
21	25B21SS	1.809	B	1/4	7/8	1 3/8	5/8	.28
22	25B22SS	1.889	B	1/4	7/16	1 7/16	5/8	.31
23	25B23SS	1.969	B	1/4	1	1 1/2	5/8	.32
24	25B24SS	2.049	B	3/8	1	1 1/2	5/8	.33
25	25B25SS	2.129	B	3/8	1	1 1/2	5/8	.34
26	25B26SS	2.209	B	3/8	1	1 1/2	5/8	.35
28	25B28SS	2.369	B	3/8	1	1 1/2	5/8	.36
30	25B30SS	2.529	B	3/8	1	1 1/2	5/8	.38
36	25B36SS	3.008	B	3/8	1	1 1/2	3/4	.50
40	25B40SS	3.327	B	1/2	1 1/8	2	3/4	.53
45	25B45SS	3.725	B	1/2	1 3/8	2	3/4	.56
60	25B60SS	4.920	B	1/2	1 3/8	2	3/4	1.10

Maximum bores shown will accommodate standard keyseat and setscrew over keyseat. Slightly larger bores are possible with no keyseat, shallow keyseat, or setscrew at angle to keyseat.

Sprockets altered at factory (rebored with key way and setscrew added) will be supplied with stainless setscrew.

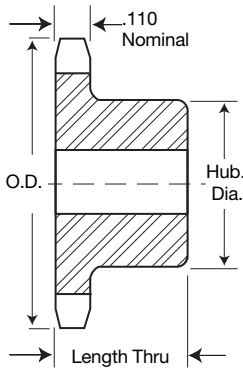

TYPE B



STAINLESS STEEL

Alteration Charges

See current discount sheet for alteration charges.

No. 35

3/8" Pitch

All Steel Stock Sprockets



Single-Type "BS" — 2 Setscrews — Bored-To-Size

No. Teeth	Catalog Number	Outside Diameter	Length Thru Bore	Weight Lbs. (Approx.)	Stock Finished Bores Includes Keyway and 2 Setscrews															
					*%	*% - *1/2	- †%	- †%	- †%	- †%	- †%	- †%	- †%	- †%						
9	35BS9	1.260	3/4	.10	*%															
10	35BS10	1.380	3/4	.11	*%	- *1/2	- †%													
11	35BS11	1.500	3/4	.15	*%	- *1/2	- †%	- †%												
12	35BS12	1.630	3/4	.18		- *1/2	- %	- †%												
13	35BS13	1.750	3/4	.20		- *1/2	- %	- %												
14	35BS14	1.870	3/4	.22		- *1/2	- %	- %												
15	35BS15	1.990	3/4	.24		- *1/2	- %	- %	- 7/8	- 1										
16	35BS16	2.110	3/4	.29		- *1/2	- %	- %	- %	- 7/8	- 1									
17	35BS17	2.230	3/4	.36		- *1/2	- %	- %	- %	- 7/8	- 1									
18	35BS18	2.350	3/4	.39		- *1/2	- %	- %	- %	- 7/8	- 1									
19	35BS19	2.470	3/4	.44		- *1/2	- %	- %	- %	- 1	- 1									
20	35BS20	2.590	3/4	.51		- *1/2	- %	- %	- %	- 1	- 1									
21	35BS21	2.710	7/8	.75		- *1/2	- %	- %	- %	- 1	- 1									
22	35BS22	2.830	7/8	.78		- *1/2	- %	- %	- %	- 1	- 1									
23	35BS23	2.950	7/8	.78		- *1/2	- %	- %	- %	- 1	- 1									
24	35BS24	3.070	7/8	.79		- *1/2	- %	- %	- %	- 1	- 1									
25	35BS25	3.190	7/8	.80		- *1/2	- %	- %	- %	- 1	- 1									
26	35BS26	3.310	7/8	.84		- %	- %	- %	- 7/8	- 1	- 1 1/8	- 1 1/16	- 1 1/4							
27	35BS27	3.430	7/8	.88		- %	- %	- %	- 7/8	- 1	- 1 1/8	- 1 1/16	- 1 1/4							
28	35BS28	3.550	7/8	.86		- %	- %	- %	- 7/8	- 1	- 1 1/8	- 1 1/16	- 1 1/4							
30	35BS30	3.790	7/8	.96		- %	- %	- %	- 7/8	- 1	- 1 1/8	- 1 1/16	- 1 1/4							
32	35BS32	4.030	7/8	1.14		- %	- %	- %	- 7/8	- 1	- 1 1/8	- 1 1/16	- 1 1/4							
35	35BS35	4.390	1	1.38		- %	- %	- %	- 7/8	- 1	- 1 1/8	- 1 1/16	- 1 1/4							
36	35BS36	4.510	1	1.41		- %	- %	- %	- 7/8	- 1	- 1 1/8	- 1 1/16	- 1 1/4							
40	35BS40	4.990	1	1.56		- %	- %	- %	- 7/8	- 1	- 1 1/8	- 1 1/16	- 1 1/4							
42	35BS42	5.230	1	1.64		- %	- %	- %	- 7/8	- 1	- 1 1/8	- 1 1/16	- 1 1/4							
45	35BS45	5.590	1	1.74		- %	- %	- %	- 7/8	- 1	- 1 1/8	- 1 1/16	- 1 1/4							
48	35BS48	5.950	1	1.86		- %	- %	- %	- 7/8	- 1	- 1 1/8	- 1 1/16	- 1 1/4							
54	35BS54	6.660	1	1.98		- %	- %	- %	- 7/8	- 1	- 1 1/8	- 1 1/16	- 1 1/4							
60	35BS60	7.380	1	2.34		- %	- %	- %	- 7/8	- 1	- 1 1/8	- 1 1/16	- 1 1/4							
70	35BS70	8.580	1	3.14		- %	- %	- %	- 7/8	- 1	- 1 1/8	- 1 1/16	- 1 1/4							
72	35BS72	8.810	1	3.30		- %	- %	- %	- 7/8	- 1	- 1 1/8	- 1 1/16	- 1 1/4							
80	35BS80	9.770	1	3.94		- %	- %	- %	- 7/8	- 1	- 1 1/8	- 1 1/16	- 1 1/4							
84	35BS84	10.250	1	4.26		- %	- %	- %	- 7/8	- 1	- 1 1/8	- 1 1/16	- 1 1/4							
96	35BS96	11.680	1	5.22		- %	- %	- %	- 7/8	- 1	- 1 1/8	- 1 1/16	- 1 1/4							
112	35BS112	13.590	1	6.50		- %	- %	- %	- 7/8	- 1	- 1 1/8	- 1 1/16	- 1 1/4							

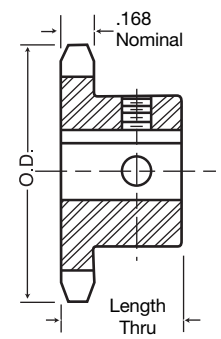

TYPE BS



BORED-TO-SIZE

*Indicates no keyway.
 † 2 1/4" setscrews only in 1/2" & 3/8" bore.
 † Keyway with Setscrew at 90°.
 Hub diameters vary to suit different bore sizes.

NOTE: KEYWAY IS ON CENTER LINE OF TOOTH.

SPROCKETS

Martin

All Steel Stock Sprockets

No. 35 3/8" Pitch

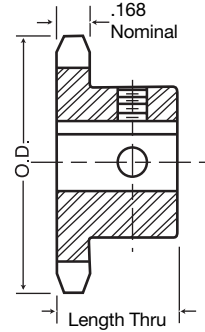

TYPE BS



BORED-TO-SIZE

SPROCKETS



No. 35-Hardened Teeth — 2 Setscrews — Bored-To-Size

No. Teeth	Catalog Number	Outside Diameter	Length Thru Bore	Weight Lbs. (Approx.)	Stock Finished Bores Includes Keyway and 2 Setscrews
9	35BS9HT	1.260	3/4	.10	*3/8
10	35BS10HT	1.380	3/4	.11	*3/8 — *1/2 — † 5/8
11	35BS11HT	1.500	3/4	.15	*3/8 — *1/2 — † 5/8 — † 3/4
12	35BS12HT	1.630	3/4	.18	— *1/2 — 5/8 — † 3/4
13	35BS13HT	1.750	3/4	.20	— *1/2 — 5/8 — 3/4
14	35BS14HT	1.870	3/4	.22	— *1/2 — 5/8 — 3/4
15	35BS15HT	1.990	3/4	.24	— *1/2 — 5/8 — 3/4 — 7/8 — 1
16	35BS16HT	2.110	3/4	.29	— *1/2 — 5/8 — 3/4 — 7/8 — 1
17	35BS17HT	2.230	3/4	.36	— *1/2 — 5/8 — 3/4 — 7/8 — 1
18	35BS18HT	2.350	3/4	.39	— *1/2 — 5/8 — 3/4 — 7/8 — 1
19	35BS19HT	2.470	3/4	.44	5/8 — 3/4 — — 1
20	35BS20HT	2.590	3/4	.51	5/8 — 3/4 — — 1
21	35BS21HT	2.710	3/4	.75	5/8 — 3/4 — — 1
22	35BS22HT	2.830	3/4	.76	5/8 — 3/4 — — 1
23	35BS23HT	2.950	3/4	.78	5/8 — 3/4 — — 1
24	35BS24HT	3.070	3/4	.79	5/8 — 3/4 — — 1
25	35BS25HT	3.190	3/4	.80	5/8 — 3/4 — — 1
26	35BS26HT	3.310	3/4	.84	5/8 — 3/4 — — 1
28	35BS28HT	3.550	3/4	.88	5/8 — 3/4 — — 1
30	35BS30HT	3.790	3/4	.96	5/8 — 3/4 — — 1

*Indicates no keyway.
 (2) 1/4" setscrews only in 1/2" & 3/8" bore at 90°.
 †Setscrews at 90° and 180° to key.

NOTE: KEYWAY IS ON CENTER LINE OF TOOTH.

Martin stock hardened teeth sprockets afford longer chain and sprocket life. Hardened teeth on the smaller sprocket of a roller chain drive are recommended if the drive ratio is four to one or greater or if the smaller sprocket has 24 teeth or less and is running at a speed of over 600 R.P.M.

No. **35**
 $\frac{3}{8}$ " Pitch

Stainless Steel
 Stock Sprockets

Martin

Single-Type B — Stainless

Single-Type A

No. Teeth	Catalog Number	Outside Diameter	Type	Bore (inches)		Hub (inches)		Weight Lbs. (Approx.)	Type	Catalog Number	Stock Bore	Weight Lbs. (Approx.)
				Stock	Rec. Max.	Diameter	Length Thru					
9	35B9SS	1.260	B	$\frac{3}{8}$	$\frac{3}{8}$	$\frac{27}{32}$ ★	$\frac{3}{8}$.10				
10	35B10SS	1.380	B	$\frac{3}{8}$	$\frac{5}{16}$	$\frac{31}{32}$ ★	$\frac{3}{8}$.15				
11	35B11SS	1.500	B	$\frac{3}{8}$	$\frac{5}{16}$	$1\frac{1}{16}$ ★	$\frac{3}{8}$.20				
12	35B12SS	1.630	B	$\frac{1}{2}$	$\frac{5}{16}$	$1\frac{1}{32}$ ★	$\frac{3}{8}$.22				
13	35B13SS	1.750	B	$\frac{1}{2}$	$\frac{3}{4}$	$1\frac{1}{4}$ ★	$\frac{3}{8}$.25				
14	35B14SS	1.870	B	$\frac{1}{2}$	$\frac{3}{4}$	$1\frac{1}{4}$	$\frac{3}{8}$.26				
15	35B15SS	1.990	B	$\frac{1}{2}$	$\frac{7}{8}$	$1\frac{1}{32}$	$\frac{3}{8}$.30				
16	35B16SS	2.110	B	$\frac{1}{2}$	$\frac{7}{8}$	$1\frac{1}{32}$	$\frac{3}{8}$.40				
17	35B17SS	2.230	B	$\frac{1}{2}$	$1\frac{1}{16}$	$1\frac{1}{16}$	$\frac{3}{8}$.43				
18	35B18SS	2.350	B	$\frac{1}{2}$	$1\frac{1}{8}$	$1\frac{29}{32}$	$\frac{3}{8}$.50				
19	35B19SS	2.470	B	$\frac{1}{2}$	$1\frac{1}{4}$	$1\frac{27}{32}$	$\frac{3}{8}$.56				
20	35B20SS	2.590	B	$\frac{1}{2}$	$1\frac{1}{8}$	$1\frac{19}{16}$	$\frac{3}{8}$.68				
21	35B21SS	2.710	B	$\frac{1}{2}$	$1\frac{3}{8}$	2	$\frac{7}{8}$.80				
22	35B22SS	2.830	B	$\frac{1}{2}$	$1\frac{3}{8}$	2	$\frac{7}{8}$.82				
23	35B23SS	2.950	B	$\frac{1}{2}$	$1\frac{3}{8}$	2	$\frac{7}{8}$.87				
24	35B24SS	3.070	B	$\frac{1}{2}$	$1\frac{3}{8}$	2	$\frac{7}{8}$.89				
25	35B25SS	3.190	B	$\frac{1}{2}$	$1\frac{3}{8}$	2	$\frac{7}{8}$.91				
26	35B26SS	3.310	B	$\frac{1}{2}$	$1\frac{3}{8}$	2	$\frac{7}{8}$.93				
28	35B28SS	3.550	B	$\frac{1}{2}$	$1\frac{3}{8}$	2	$\frac{7}{8}$	1.00				
30	35B30SS	3.790	B	$\frac{1}{2}$	$1\frac{3}{8}$	2	$\frac{7}{8}$	1.06				
35	35B35SS	4.390	B	$\frac{3}{4}$	$1\frac{1}{2}$	$2\frac{1}{4}$	$\frac{7}{8}$	1.56				
40	35B40SS	4.990	B	$\frac{3}{4}$	$1\frac{1}{2}$	$2\frac{1}{4}$	1	1.70	A	35A40SS	$\frac{19}{32}$	1.04
45	35B45SS	5.590	B	$\frac{3}{4}$	$1\frac{1}{2}$	$2\frac{1}{4}$	1	2.18	A	35A45SS	$\frac{19}{32}$	1.26
60	35B60SS	7.380	B	$\frac{3}{4}$	$1\frac{1}{2}$	$2\frac{1}{4}$	1	3.00	A	35A60SS	$\frac{23}{32}$	2.10

★ Has recessed groove in hub for chain clearance.

Maximum bores shown will accommodate standard keyseat and setscrew over keyseat. Slightly larger bores are possible with no keyseat, shallow keyseat, or setscrew at angle to keyseat.

Sprockets altered at factory (rebored with keyway and setscrew added) will be supplied with stainless setscrew.

SPROCKETS

Alteration Charges

See current discount sheet for alteration charges.



STAINLESS STEEL

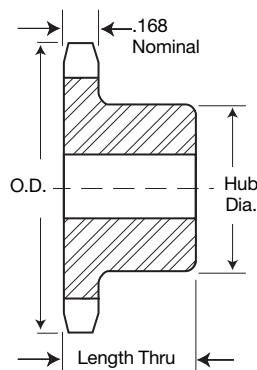

TYPE B

Single-Type B — Steel

Single-Type A

No. Teeth	Catalog Number	Outside Diameter	Type	Bore (inches)		Hub (inches)		Weight Lbs. (Approx.)	Type	Catalog Number	Stock Bore	Weight Lbs. (Approx.)
				Stock	Rec. Max.	Diameter	Length Thru					
8	35B8	1.130	B	3/8	3/8	3/8*	3/8	.07				
9	35B9	1.260	B	3/8	3/8	27/64*	3/8	.09				
10	35B10	1.380	B	3/8	3/8	33/64*	3/8	.14				
11	35B11	1.500	B	3/8	3/8	11/16*	3/8	.17				
12	35B12	1.630	B	1/2	3/8	11/16*	3/8	.20				
13	35B13	1.750	B	1/2	11/16	11/16*	3/8	.23				
14	35B14	1.870	B	1/2	7/8	11/16	3/8	.25				
15	35B15	1.990	B	1/2	7/8	11/16	3/8	.29	A	35A15	1/2	.10
16	35B16	2.110	B	1/2	7/8	11/16	3/8	.35	A	35A16	1/2	.12
17	35B17	2.230	B	1/2	11/16	11/16	3/8	.42	A	35A17	1/2	.12
18	35B18	2.350	B	1/2	11/16	11/16	3/8	.48	A	35A18	1/2	.14
19	35B19	2.470	B	1/2	11/16	11/16	3/8	.54	A	35A19	1/2	.16
20	35B20	2.590	B	1/2	11/16	11/16	3/8	.59	A	35A20	1/2	.20
21	35B21	2.710	B	1/2	11/16	2	7/8	.80	A	35A21	1/2	.20
22	35B22	2.830	B	1/2	11/16	2	7/8	.80	A	35A22	1/2	.22
23	35B23	2.950	B	1/2	11/16	2	7/8	.82	A	35A23	1/2	.24
24	35B24	3.070	B	1/2	11/16	2	7/8	.88	A	35A24	1/2	.26
25	35B25	3.190	B	1/2	11/16	2	7/8	.88	A	35A25	1/2	.28
26	35B26	3.310	B	1/2	11/16	2	7/8	.90	A	35A26	1/2	.28
27	35B27	3.430	B	1/2	11/16	2	7/8	.94	A	35A27	1/2	.34
28	35B28	3.550	B	1/2	11/16	2	7/8	.94	A	35A28	1/2	.34
30	35B30	3.790	B	1/2	11/16	2	7/8	1.02	A	35A30	1/2	.46
32	35B32	4.030	B	1/2	11/16	2	7/8	1.24	A	35A32	5/8	.46
35	35B35	4.390	B	3/4	11/16	2 1/4	7/8	1.50	A	35A35	5/8	.60
36	35B36	4.510	B	3/4	11/16	2 1/4	7/8	1.56	A	35A36	5/8	.62
40	35B40	4.990	B	3/4	11/16	2 1/4	1	1.62	A	35A40	19/32	.70
42	35B42	5.230	B	3/4	11/16	2 1/4	1	1.68	A	35A42	19/32	.78
45	35B45	5.590	B	3/4	11/16	2 1/4	1	1.78	A	35A45	19/32	.88
48	35B48	5.950	B	3/4	11/16	2 1/4	1	1.88	A	35A48	19/32	1.21
54	35B54	6.660	B	3/4	11/16	2 1/4	1	2.20	A	35A54	19/32	1.32
60	35B60	7.380	B	3/4	11/16	2 1/4	1	2.48	A	35A60	23/32	1.66
70	35B70	8.580	B	3/4	11/16	2 1/4	1	3.12	A	35A70	23/32	2.30
72	35B72	8.810	B	3/4	11/16	2 1/4	1	3.42	A	35A72	23/32	2.56
80	35B80	9.770	B	3/4	11/16	2 1/4	1	3.82	A	35A80	23/32	3.16
84	35B84	10.250	B	3/4	11/16	2 1/4	1	4.24	A	35A84	23/32	3.26
96	35B96	11.680	B	3/4	11/16	2 1/4	1	5.16	A	35A96	23/32	4.64
112	35B112	13.590	B	3/4	11/16	2 1/4	1	6.70	A	35A112	23/32	5.05

* Has recessed groove in hub for chain clearance.

Maximum bores shown will accommodate standard keyseat and setscrew over keyseat. Slightly larger bores are possible with no keyseat, shallow keyseat, or setscrew at angle to keyseat.

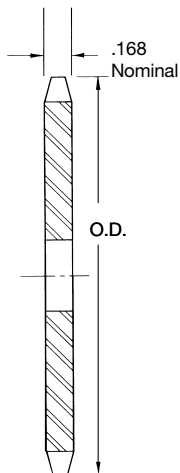

TYPE A



TYPE A

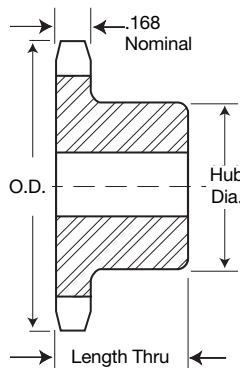

TYPE B



TYPE B

Alteration Charges

See current discount sheet for alteration charges.

No. 35
3/8" Pitch

All Steel
Stock Sprockets

Martin

Single-Taper Bushed

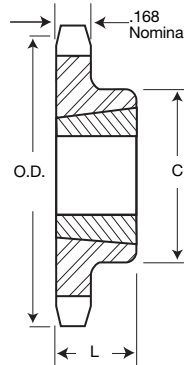

TYPE B

SPROCKETS

Single-Taper Bushed

No. Teeth	Catalog Number	Bushing	Diameter		Max. Bore	Dimensions		Type	Weight (Approx.)	
			Outside Diameter	Pitch Diameter		L	C		Rim Only	Bushing Only
18	35BTB18	1008	2.352	2.159	1	7/8	1 1/8*	B	.4	.3
19	35BTB19	1008	2.472	2.278	1	7/8	1 1/16	B	.5	.3
20	35BTB20	1008	2.593	2.397	1	7/8	1 1/8	B	.6	.3
21	35BTB21	1008	2.713	2.516	1	7/8	2 1/16	B	.7	.3
22	35BTB22	1210	2.883	2.635	1 1/4	1	2 3/8*	B	.8	.6
23	35BTB23	1210	2.954	2.754	1 1/4	1	2 1/16	B	.9	.6
24	35BTB24	1210	3.074	2.873	1 1/4	1	2 1/16	B	.9	.6
25	35BTB25	1210	3.194	2.992	1 1/4	1	2 1/16	B	1.2	.6
26	35BTB26	1610	3.314	3.111	1 1/2	1	2 3/8*	B	1.1	.9
28	35BTB28	1610	3.553	3.349	1 1/2	1	2 3/8	B	1.2	.9
30	35BTB30	1610	3.793	3.588	1 1/2	1	3 1/8	B	1.2	.9
32	35BTB32	1610	4.032	3.826	1 1/2	1	3 1/8	B	1.3	.9
35	35BTB35	1610	4.392	4.183	1 1/2	1	3 3/8	B	1.4	.9
36	35BTB36	1610	4.511	4.303	1 1/2	1	3 3/8	B	1.4	.9
40	35BTB40	1610	4.990	4.786	1 1/2	1	3 3/8	B	1.9	.9
42	35BTB42	1610	5.229	5.018	1 1/2	1	3 3/8	B	2.0	.9
45	35BTB45	1610	5.588	5.376	1 1/2	1	3 3/8	B	2.1	.9
48	35BTB48	1610	5.946	5.734	1 1/2	1	3 3/8	B	2.3	.9
54	35BTB54	1610	6.663	6.449	1 1/2	1	3 3/8	B	2.6	.9
60	35BTB60	1610	7.380	7.165	1 1/2	1	3 3/8	B	3.0	.9
70	35BTB70	1610	8.575	8.358	1 1/2	1	3 3/8	B	3.7	.9
72	35BTB72	1610	8.814	8.597	1 1/2	1	3 3/8	B	3.9	.9
80	35BTB80	1610	9.770	9.552	1 1/2	1	3 3/8	B	4.5	.9
84	35BTB84	1610	10.247	10.029	1 1/2	1	3 3/8	B	4.9	.9
96	35BTB96	1610	11.680	11.461	1 1/2	1	3 3/8	B	6.0	.9
112	35BTB112	1610	13.590	13.371	1 1/2	1	3 3/8	B	7.8	.9

* Has recessed groove in hub for chain clearance.

Single-Type QD

No. Teeth	Catalog Number	Bushing	Diameters		Type	Max. Bore	Dimensions							Weight (Approx.)	
			Outside Diameter	Pitch Diameter			L ₁	L ₂	C	Y	G	X	T	With Hub	Rim Only
19	35JA19	JA	2.470	2.278	B	1 1/4	1 1/8	1 1/8	2 1/16	5/64	29/64	5/8	.168	1.18	.28
20	35JA20	JA	2.590	2.397	B	1 1/4	1 1/8	1 1/8	2 1/16	5/64	29/64	5/8	.168	1.22	.32
21	35JA21	JA	2.710	2.516	B	1 1/4	1 1/8	1 1/8	2 1/16	5/64	29/64	5/8	.168	1.24	.34
22	35JA22	JA	2.830	2.635	B	1 1/4	1 1/8	1 1/8	2 1/16	5/64	29/64	5/8	.168	1.26	.36
23	35JA23	JA	2.950	2.754	B	1 1/4	1 1/8	1 1/8	2 1/16	5/64	29/64	5/8	.168	1.28	.38
24	35JA24	JA	3.070	3.873	B	1 1/4	1 1/8	1 1/8	2 1/16	5/64	29/64	5/8	.168	1.30	.40
25	35JA25	JA	3.190	2.992	B	1 1/4	1 1/8	1 1/8	2 1/16	5/64	29/64	5/8	.168	1.34	.44
26	35JA26	JA	3.310	3.111	B	1 1/4	1 1/8	1 1/8	2 1/16	5/64	29/64	5/8	.168	1.36	.46
27	35JA27	JA	3.430	3.230	B	1 1/4	1 1/8	1 1/8	2 1/16	5/64	29/64	5/8	.168	1.38	.48
28	35JA28	JA	3.550	3.349	B	1 1/4	1 1/8	1 1/8	2 1/16	5/64	29/64	5/8	.168	1.42	.52
30	35JA30	JA	3.790	3.588	B	1 1/4	1 1/8	1 1/8	2 1/16	5/64	29/64	5/8	.168	1.46	.56
32	35JA32	JA	4.030	3.826	B	1 1/4	1 1/8	1 1/8	2 1/16	5/64	29/64	5/8	.168	1.68	.78
35	35JA35	JA	4.390	4.183	B	1 1/4	1 1/8	1 1/8	2 1/16	5/64	29/64	5/8	.168	1.94	1.04
36	35SH36	SH	4.510	4.303	B	1 1/4	1 1/8	1 1/8	2 1/16	1 1/64	4 1/64	13 1/16	.168	2.06	1.06
40	35SH40	SH	4.990	4.780	B	1 1/4	1 1/8	1 1/8	2 1/16	1 1/64	4 1/64	13 1/16	.168	2.18	1.18
42	35SH42	SH	5.230	5.018	B	1 1/4	1 1/8	1 1/8	2 1/16	1 1/64	4 1/64	13 1/16	.168	2.26	1.26
45	35SH45	SH	5.590	5.376	B	1 1/4	1 1/8	1 1/8	2 1/16	1 1/64	4 1/64	13 1/16	.168	2.40	1.40
48	35SH48	SH	5.950	5.734	B	1 1/4	1 1/8	1 1/8	2 1/16	1 1/64	4 1/64	13 1/16	.168	2.58	1.58
54	35SH54	SH	6.660	6.449	B	1 1/4	1 1/8	1 1/8	2 1/16	1 1/64	4 1/64	13 1/16	.168	2.88	1.88
60	35SH60	SH	7.380	7.165	B	1 1/4	1 1/8	1 1/8	2 1/16	1 1/64	4 1/64	13 1/16	.168	3.28	2.28
70	35SH70	SH	8.580	8.358	B	1 1/4	1 1/8	1 1/8	2 1/16	1 1/64	4 1/64	13 1/16	.168	3.94	2.94
72	35SH72	SH	8.810	8.597	B	1 1/4	1 1/8	1 1/8	2 1/16	1 1/64	4 1/64	13 1/16	.168	4.14	3.14
80	35SH80	SH	9.770	9.552	B	1 1/4	1 1/8	1 1/8	2 1/16	1 1/64	4 1/64	13 1/16	.168	4.68	3.68
84	35SH84	SH	10.250	10.029	B	1 1/4	1 1/8	1 1/8	2 1/16	1 1/64	4 1/64	13 1/16	.168	4.86	3.96
96	35SH96	SH	11.680	11.461	B	1 1/4	1 1/8	1 1/8	2 1/16	1 1/64	4 1/64	13 1/16	.168	6.38	5.38
112	35SH112	SH	13.590	13.371	B	1 1/4	1 1/8	1 1/8	2 1/16	1 1/64	4 1/64	13 1/16	.168	7.60	6.60

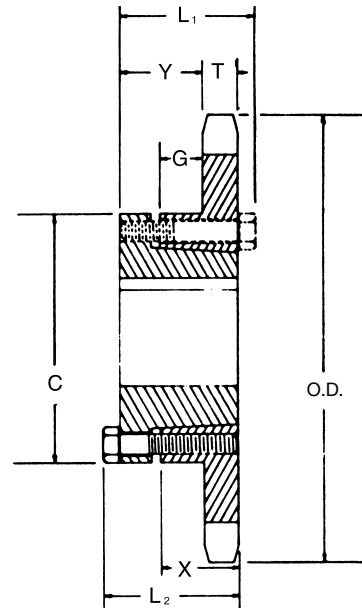

“QD” — TYPE B

No. 35
3/8" Pitch

MST®
Sprockets

Martin

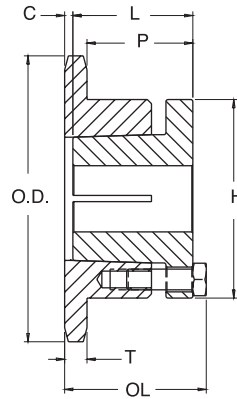

TYPE 3

SPROCKETS

Single - MST® Sprockets

No. Teeth	Catalog Number	Bush-ing	Diameters		Type	Max. Bore	Dimensions						Weight (Approx.)	
			Outside Dia.	Pitch Dia.			OL	L	C	H	P	T(nom)	With Hub	Rim Only
19	35H19	H	2.470	2.278	3	1-1/2	1-1/2	1-1/4	1/16	2-1/2	1-5/32	.168	1.3	.5
20	35H20	H	2.590	2.397	3	1-1/2	1-1/2	1-1/4	1/16	2-1/2	1-5/32	.168	1.3	.5
21	35H21	H	2.710	2.516	3	1-1/2	1-1/2	1-1/4	1/16	2-1/2	1-5/32	.168	1.4	.6
22	35H22	H	2.830	2.635	3	1-1/2	1-1/2	1-1/4	1/16	2-1/2	1-5/32	.168	1.5	.7
23	35H23	H	2.950	2.754	3	1-1/2	1-1/2	1-1/4	1/16	2-1/2	1-5/32	.168	1.5	.7
24	35H24	H	3.070	2.873	3	1-1/2	1-1/2	1-1/4	1/16	2-1/2	1-5/32	.168	1.6	.8
25	35H25	H	3.190	2.992	3	1-1/2	1-1/2	1-1/4	1/16	2-1/2	1-5/32	.168	1.6	.8
26	35H26	H	3.310	3.111	3	1-1/2	1-1/2	1-1/4	1/16	2-1/2	1-5/32	.168	1.6	.8
28	35H28	H	3.550	3.349	3	1-1/2	1-1/2	1-1/4	1/16	2-1/2	1-5/32	.168	1.7	.9
30	35H30	H	3.790	3.588	3	1-1/2	1-1/2	1-1/4	1/16	2-1/2	1-5/32	.168	1.7	.9
32	35H32	H	4.030	3.826	3	1-1/2	1-1/2	1-1/4	1/16	2-1/2	1-5/32	.168	1.7	.9
35	35H35	H	4.390	4.183	3	1-1/2	1-1/2	1-1/4	1/16	2-1/2	1-5/32	.168	1.8	1.0
36	35H36	H	4.510	4.303	3	1-1/2	1-1/2	1-1/4	1/16	2-1/2	1-5/32	.168	1.8	1.0
40	35H40	H	4.990	4.780	3	1-1/2	1-1/2	1-1/4	1/16	2-1/2	1-5/32	.168	2.0	1.2
42	35H42	H	5.230	5.018	3	1-1/2	1-1/2	1-1/4	1/16	2-1/2	1-5/32	.168	2.0	1.2
45	35H45	H	5.590	5.376	3	1-1/2	1-1/2	1-1/4	1/16	2-1/2	1-5/32	.168	2.2	1.4
48	35H48	H	5.950	5.734	3	1-1/2	1-1/2	1-1/4	1/16	2-1/2	1-5/32	.168	2.3	1.5
54	35H54	H	6.660	6.449	3	1-1/2	1-1/2	1-1/4	1/16	2-1/2	1-5/32	.168	2.6	1.8
60	35H60	H	7.380	7.165	3	1-1/2	1-1/2	1-1/4	1/16	2-1/2	1-5/32	.168	3.1	2.3
70	35H70	H	8.580	8.358	3	1-1/2	1-1/2	1-1/4	1/16	2-1/2	1-5/32	.168	3.6	2.8
72	35H72	H	8.810	8.597	3	1-1/2	1-1/2	1-1/4	1/16	2-1/2	1-5/32	.168	3.8	3.0
80	35H80	H	9.770	9.552	3	1-1/2	1-1/2	1-1/4	1/16	2-1/2	1-5/32	.168	4.6	3.8
84	35H84	H	10.250	10.029	3	1-1/2	1-1/2	1-1/4	1/16	2-1/2	1-5/32	.168	4.8	4.0
96	35H96	H	11.680	11.461	3	1-1/2	1-1/2	1-1/4	1/16	2-1/2	1-5/32	.168	6.1	5.3
112	35H112	H	13.590	13.371	3	1-1/2	1-1/2	1-1/4	1/16	2-1/2	1-5/32	.168	7.6	6.8

Double-Type B

No. Teeth	Catalog Number	Outside Diameter	Type	Bore (inches)		Hub (inches)		Weight Lbs. (Approx.)
				Stock	Rec. Max.	Dia.	Length Thru	
12	D35B12H	1.630	B	1/2	5/16	5/8	1 1/4	.32
13	D35B13H	1.750	B	1/2	1/2	1 1/4	1 1/4	.36
14	D35B14H	1.870	B	1/2	5/8	1 1/2	1 1/4	.44
15	D35B15H	1.990	B	1/2	15/16	1 3/8	1 1/4	.56
16	D35B16H	2.110	B	1/2	15/16	1 1/2	1 1/4	.64
17	D35B17H	2.230	B	3/4	1 1/16	1 5/8	1 1/4	.74
18	D35B18H	2.350	B	3/4	1 1/8	1 3/4	1 1/4	.84
19	D35B19H	2.470	B	3/4	1 1/4	1 7/8	1 1/4	.96
20	D35B20H	2.590	B	3/4	1 1/2	1 3/4	1 1/4	1.08
21	D35B21H	2.710	B	3/4	1 3/8	2 1/8	1 1/4	1.24
22	D35B22H	2.830	B	3/4	1 1/2	2 1/4	1 1/4	1.42
23	D35B23H	2.950	B	3/4	1 3/4	2 1/2	1 1/4	1.54
24	D35B24H	3.070	B	3/4	1 7/8	2 3/4	1 1/4	1.62
25	D35B25H	3.190	B	3/4	1 7/8	2 3/4	1 1/2	1.66
26	D35B26	3.310	B	3/4	1 7/8	2 3/4	1 1/2	1.98
30	D35B30	3.790	B	3/4	1 7/8	2 3/4	1 1/2	2.34
36	D35B36	4.510	B	3/4	1 7/8	2 3/4	1 1/2	3.00
42	D35B42	5.230	B	3/4	1 7/8	2 3/4	1 1/2	3.80
48	D35B48	5.950	B	3/4	1 7/8	2 3/4	1 1/2	4.66
52	D35B52	6.430	B	3/4	1 7/8	2 3/4	1 1/2	5.40
60	D35B60	7.380	B	3/4	1 7/8	2 3/4	1 1/2	6.84
68	D35B68	8.340	B	3/4	2 3/8	3 1/2	1 1/2	10.01
72	D35B72	8.810	B	3/4	2 3/8	3 1/2	1 1/2	11.04
76	D35B76	9.290	B	3/4	2 3/8	3 1/2	1 1/2	11.94
84	D35B84	10.250	B	3/4	2 3/8	3 1/2	1 1/2	14.98
95	D35B95	11.560	B	1	2 3/8	3 1/2	1 1/2	17.42
96	D35B96	11.680	B	1	2 3/8	3 1/2	1 1/2	18.14
102	D35B102	12.400	B	1	2 3/8	3 1/2	1 1/2	19.92

Maximum bores shown will accommodate standard keyseat and setscrew over keyseat. Slightly larger bores are possible with no keyseat, shallow keyseat, or setscrew at angle to keyseat. Sprockets with "H" suffix have hardened teeth.

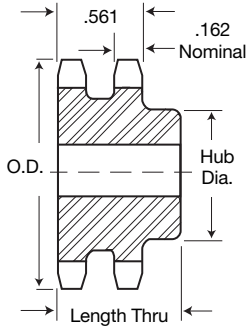

TYPE B

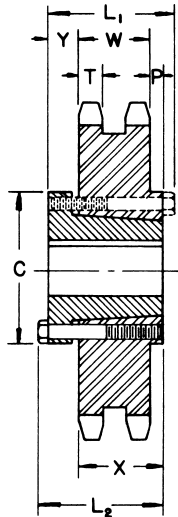

"QD" — TYPE C

Double-Taper Bushed

No. Teeth	Catalog Number	Bushing	Diameters		Max. Bore	Dimensions			Weight (Approx.)	
			Outside Diameter	Pitch Diameter		L	C	Type	Rim Only	Bushing Only
19	D35BTB19H	1008	2.472	2.278	1	7/8	1 3/4	B	.6	.3
20	D35BTB20H	1008	2.593	2.397	1	7/8	1 5/8	B	.8	.3
21	D35BTB21H	1008	2.713	2.516	1	7/8	2 1/8	B	1.4	.3
22	D35BTB22H	1008	2.833	2.635	1	7/8	2 1/8	B	1.7	.3
23	D35BTB24H	1210	3.074	2.873	1 1/4	1	2 1/8	B	1.8	.6
26	D35BTB26	1210	3.314	3.111	1 1/4	1	2 3/8	B	2.0	.6
30	D35BTB30	1610	3.793	3.588	1 1/2	1	3 1/8	B	1.8	.9
32	D35BTB32	1610	4.032	3.826	1 1/2	1	3 1/4	B	2.0	.9
35	D35BTB35	1610	4.392	4.183	1 1/2	1	3 1/2	B	2.3	.9
40	D35BTB40	1610	4.990	4.780	1 1/2	1	3 3/4	B	2.9	.9
45	D35BTB45	1610	5.588	5.376	1 1/2	1	3 3/4	B	3.2	.9
48	D35BTB48	1610	5.946	5.734	1 1/2	1	3 3/8	B	3.5	.9
54	D35BTB54	1610	6.663	6.449	1 1/2	1	3 3/8	B	3.9	.9
60	D35BTB60	1610	7.380	7.165	1 1/2	1	3 3/8	B	4.9	.9
70	D35BTB70	1610	8.575	8.358	1 1/2	1	3 3/8	B	6.3	.9
80	D35BTB80	1610	9.770	9.552	1 1/2	1	3 3/8	B	7.9	.9
96	D35BTB96	1610	11.680	11.461	1 1/2	1	3 3/8	B	9.9	.9
112	D35BTB112	1610	13.590	13.371	1 1/2	1	3 3/8	B	10.9	.9

Sprockets with "H" suffix have hardened teeth.

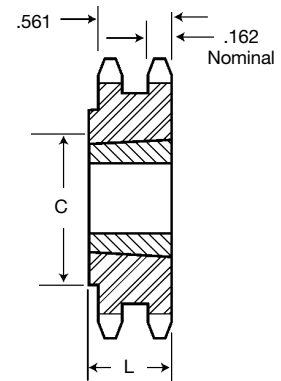

TAPER BUSHED
TYPE B

Double-Type QD

No. Teeth	Catalog Number	Bush-ing	Diameters		Type	Max. Bore	Dimensions							Weight (Approx.)		
			Outside Diameter	Pitch Diameter			L ₁	L ₂	C	Y	P	X	T	W	With Hub	Rim Only
68	D35SDS68	SDS	8.340	8.120	C	2	1 1/2	1 1/2	3 3/8	5/8	5/8	3/4	.162	.561	8.40	7.40
72	D35SDS72	SDS	8.810	8.597	C	2	1 1/2	1 1/2	3 3/8	5/8	5/8	3/4	.162	.561	9.28	8.28
76	D35SDS76	SDS	9.290	9.074	C	2	1 1/2	1 1/2	3 3/8	5/8	5/8	3/4	.162	.561	10.32	9.32
84	D35SK84	SK	10.250	10.029	C	2 1/2	2 1/2	2 1/2	3 3/8	5/8	1 1/8	1 1/4	.162	.561	13.94	11.94
95	D35SK95	SK	11.560	11.342	C	2 1/2	2 1/2	2 1/2	3 3/8	5/8	1 1/8	1 1/4	.162	.561	17.22	15.22
96	D35SK96	SK	11.680	11.461	C	2 1/2	2 1/2	2 1/2	3 3/8	5/8	1 1/8	1 1/4	.162	.561	17.74	15.74
102	D35SK102	SK	12.400	12.177	C	2 1/2	2 1/2	2 1/2	3 3/8	5/8	1 1/8	1 1/4	.162	.561	19.76	17.76

No. 35-3

3/8" Pitch

All Steel Stock Sprockets

Martin

Triple-Type B

No. Teeth	Catalog Number	Outside Diameter	Type	Bore (inches)		Hub (inches)		Weight Lbs. (Approx.)
				Stock	Rec. Max.	Dia.	Length Thru	
13	E35B13H	1.750	B	1/2	11/16	1 1/4	1 1/4	.50
14	E35B14H	1.870	B	1/2	7/8	1 1/4	1 1/4	.62
15	E35B15H	1.990	B	1/2	15/16	1 1/2	1 1/4	.78
16	E35B16H	2.110	B	1/2	1 1/16	1 1/2	1 1/4	.82
17	E35B17H	2.230	B	1/2	1 1/8	1 3/2	1 1/4	1.04
18	E35B18H	2.350	B	1/2	1 1/8	1 3/2	1 1/4	1.22
19	E35B19H	2.470	B	1/2	1 1/8	1 1/2	1 1/4	1.40
20	E35B20H	2.590	B	3/4	1 1/8	1 1/2	1 1/4	1.50
21	E35B21H	2.710	B	3/4	1 1/8	2 1/8	1 1/4	1.72
22	E35B22H	2.830	B	3/4	1 1/8	2 1/8	1 1/4	1.96
23	E35B23H	2.950	B	3/4	1 1/8	2 1/4	1 1/4	2.12
24	E35B24H	3.070	B	3/4	1 1/8	2 1/4	1 1/4	2.26
25	E35B25H	3.190	B	3/4	1 1/2	2 1/4	1 1/4	2.42
26	E35B26	3.310	B	3/4	1 1/2	2 1/2	1 1/4	2.78
30	E35B30	3.790	B	3/4	1 1/2	2 1/2	1 1/4	3.42
36	E35B36	4.510	B	3/4	1 1/2	2 1/2	1 1/4	4.52
42	E35B42	5.230	B	3/4	1 1/2	2 1/2	1 1/4	5.88
48	E35B48	5.950	B	3/4	1 1/2	2 1/2	1 1/4	7.42
52	E35B52	6.430	B	3/4	1 1/2	2 1/2	1 1/4	8.52
60	E35B60	7.380	B	3/4	1 1/2	2 1/2	1 1/4	11.22
68	E35B68	8.340	B	3/4	2 1/8	3 1/2	1 1/4	15.38
72	E35B72	8.810	B	3/4	2 1/8	3 1/2	1 1/4	17.34
76	E35B76	9.290	B	3/4	2 1/8	3 1/2	1 1/4	18.90
84	E35B84	10.250	B	3/4	2 1/8	3 1/2	1 1/4	22.82
95	E35B95	11.560	B	1	2 1/2	3 3/4	2 1/4	29.32
96	E35B96	11.680	B	1	2 1/2	3 3/4	2 1/4	30.06
102	E35B102	12.400	B	1	2 1/2	3 3/4	2 1/4	33.36

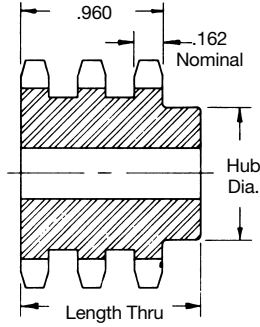

TYPE B

Alteration Charges

See current discount sheet for alteration charges.

Maximum bores shown will accommodate standard keyseat and setscrew over keyseat. Slightly larger bores are possible with no keyseat, shallow keyseat, or setscrew at angle to keyseat.

NOTE: Triple 35 stock sprockets with 25 teeth or less have hardened teeth. Sprockets with "H" suffix have hardened teeth.

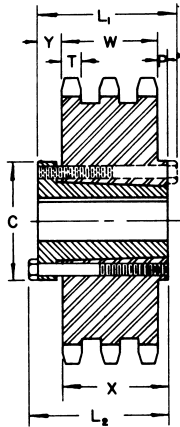

"QD" — TYPE C

Triple-Type QD

No. Teeth	Catalog Number	Bush-ing	Diameters		Type	Max. Bore	Dimensions								Weight (Approx.)	
			Outside Diameter	Pitch Diameter			L ₁	L ₂	C	Y	P	X	T	W	With Hub	Rim Only
68	E35SK68	SK	8.340	8.120	C	2 1/8	2 1/2	2 1/2	3 3/8	3/8	1 1/4	1 1/4	.162	.960	13.90	11.90
72	E35SK72	SK	8.810	8.597	C	2 1/8	2 1/2	2 1/2	3 3/8	3/8	1 1/4	1 1/4	.162	.960	15.56	13.56
76	E35SK76	SK	9.290	9.074	C	2 1/8	2 1/2	2 1/2	3 3/8	3/8	1 1/4	1 1/4	.162	.960	17.42	15.42
84	E35SK84	SK	10.250	10.029	C	2 1/8	2 1/2	2 1/2	3 3/8	3/8	1 1/4	1 1/4	.162	.960	20.92	18.92
95	E35SK95	SK	11.560	11.342	C	2 1/2	2 1/2	2 1/2	3 3/8	3/8	1 1/4	1 1/4	.162	.960	26.76	24.76
96	E35SK96	SK	11.680	11.461	C	2 1/8	2 1/2	2 1/2	3 3/8	3/8	1 1/4	1 1/4	.162	.960	27.58	25.58
102	E35SK102	SK	12.400	12.177	C	2 1/8	2 1/2	2 1/2	3 3/8	3/8	1 1/4	1 1/4	.162	.960	31.18	29.18

Single-Type "BS"— 2 Setscrews — Bored-To-Size

No. Teeth	Catalog Number	Outside Diameter	Length Thru Bore	Weight Lbs. (Approx.)	Stock Finished Bores Includes Keyway and 2 Setscrews
9	41BS9	1.670	7/8	.20	— 1/2 — 3/8
10	41BS10	1.840	7/8	.25	— 1/2 — 3/8
11	41BS11	2.000	7/8	.32	— 1/2 — 3/8 — 3/8
12	41BS12	2.170	7/8	.33	— 1/2 — 3/8 — 3/8 — 7/8
13	41BS13	2.330	7/8	.43	— 1/2 — 3/8 — 3/8 — 7/8 — 1
14	41BS14	2.490	7/8	.48	— 1/2 — 3/8 — 3/8 — 7/8 — 1
15	41BS15	2.650	7/8	.59	— 1/2 — 3/8 — 3/8 — 1
16	41BS16	2.810	7/8	.72	— 3/8 — 3/8 — 1
17	41BS17	2.970	1	1.00	— 3/8 — 3/8 — 1
18	41BS18	3.140	1	1.10	— 3/8 — 3/8 — 1
19	41BS19	3.300	1	1.21	— 3/8 — 3/8 — 1
20	41BS20	3.460	1	1.39	— 3/8 — 3/8 — 1
21	41BS21	3.620	1	1.77	— 3/8 — 3/8 — 1
22	41BS22	3.780	1	1.92	— 3/8 — 3/8 — 1
23	41BS23	3.940	1	2.18	— 3/8 — 3/8 — 1
24	41BS24	4.100	1	2.24	— 3/8 — 3/8 — 1
25	41BS25	4.260	1	2.42	— 3/8 — 3/8 — 1
26	41BS26	4.420	1	2.46	— 3/8 — 3/8 — 1
27	41BS27	4.580	1	2.52	— 3/8 — 3/8 — 1
28	41BS28	4.740	1	2.60	— 3/8 — 3/8 — 1
30	41BS30	5.060	1	2.76	— 3/8 — 3/8 — 1
32	41BS32	5.380	1	2.92	— 3/8 — 3/8 — 1
35	41BS35	5.860	1	3.08	— 3/8 — 3/8 — 1
36	41BS36	6.020	1	3.28	— 3/8 — 3/8 — 1
40	41BS40	6.650	1 1/8	3.82	— 3/8 — 1 — 1 1/8 — 1 1/8 — 1 1/8 — 1 1/8 — 1 1/8 — 1 1/8
42	41BS42	6.970	1 1/8	3.68	— 3/8 — 1 — 1 1/8 — 1 1/8 — 1 1/8 — 1 1/8 — 1 1/8 — 1 1/8
45	41BS45	7.450	1 1/8	3.94	— 3/8 — 1 — 1 1/8 — 1 1/8 — 1 1/8 — 1 1/8 — 1 1/8 — 1 1/8
48	41BS48	7.930	1 1/8	4.68	— 3/8 — 1 — 1 1/8 — 1 1/8 — 1 1/8 — 1 1/8 — 1 1/8 — 1 1/8
54	41BS54	8.880	1 1/8	5.44	— 3/8 — 1 — 1 1/8 — 1 1/8 — 1 1/8 — 1 1/8 — 1 1/8 — 1 1/8
60	41BS60	9.840	1 1/8	6.54	— 3/8 — 1 — 1 1/8 — 1 1/8 — 1 1/8 — 1 1/8 — 1 1/8 — 1 1/8
70	41BS70	11.430	1 3/8	9.28	— 3/8 — 1 — 1 1/8 — 1 1/8 — 1 1/8 — 1 1/8 — 1 1/8 — 1 1/8
72	41BS72	11.750	1 3/8	9.38	— 3/8 — 1 — 1 1/8 — 1 1/8 — 1 1/8 — 1 1/8 — 1 1/8 — 1 1/8
80	41BS80	13.030	1 3/8	11.28	— 3/8 — 1 — 1 1/8 — 1 1/8 — 1 1/8 — 1 1/8 — 1 1/8 — 1 1/8
84	41BS84	13.660	1 3/8	11.94	— 3/8 — 1 — 1 1/8 — 1 1/8 — 1 1/8 — 1 1/8 — 1 1/8 — 1 1/8
96	41BS96	15.570	1 3/8	14.51	1 — 1 1/8 — 1 1/8 — 1 1/8 — 1 1/8 — 1 1/8 — 1 1/8 — 1 1/8
112	41BS112	18.120	1 3/8	18.81	1 — 1 1/8 — 1 1/8 — 1 1/8 — 1 1/8 — 1 1/8 — 1 1/8 — 1 1/8

*Indicates no keyway. (2) 1/8" Setscrews only in 1/2" bore.
Hub diameters vary to suit different bore sizes.

NOTE: KEYWAY IS ON CENTER LINE OF TOOTH.



BORED-TO-SIZE

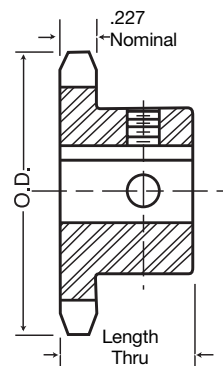

TYPE BS

No. 41

1/2" Pitch

All Steel Stock Sprockets

Martin

Single-Type B

Single-Type A

No. Teeth	Catalog Number	Outside Diameter	Type	Bore (inches)		Hub (inches)		Weight Lbs. (Approx.)	Type	Catalog Number	Stock Bore	Weight Lbs. (Approx.)
				Stock	Rec. Max.	Diameter	Length Thru					
6	41B6	1.170	B	3/8	3/8	2 1/32*	3/8	.07				
7	41B7	1.340	B	3/8	3/8	3/8*	3/8	.10				
8	41B8	1.510	B	1/2	1/2	9/16*	3/8	.19				
9	41B9	1.670	B	1/2	5/8	1 1/8*	3/8	.20				
10	41B10	1.840	B	1/2	3/4	1 1/8*	3/8	.27				
11	41B11	2.000	B	1/2	3/4	1 1/8*	3/8	.35				
12	41B12	2.170	B	1/2	1 1/16	1 1/8*	3/8	.44				
13	41B13	2.330	B	1/2	1	1 1/8*	3/8	.50				
14	41B14	2.490	B	1/2	1 1/4	1 1/8	3/8	.57	A	41A15	3/8	.28
15	41B15	2.650	B	1/2	1 1/8	1 9/16	3/8	.72	A	41A16	3/8	.34
16	41B16	2.810	B	5/8	1 1/8	2 1/16	3/8	.91	A	41A17	3/8	.36
17	41B17	2.970	B	5/8	1 1/2	2 1/8	1	1.09	A			
18	41B18	3.140	B	5/8	1 1/8	2 3/8	1	1.25	A	41A18	3/8	.44
19	41B19	3.300	B	5/8	1 1/4	2 1/2	1	1.49	A	41A19	3/8	.46
20	41B20	3.460	B	5/8	1 1/2	2 3/4	1	1.64	A	41A20	3/8	.52
21	41B21	3.620	B	5/8	1 3/4	2 7/8	1	1.81	A	41A21	3/8	.60
22	41B22	3.780	B	5/8	2	3	1	1.93	A	41A22	3/8	.66
23	41B23	3.940	B	5/8	2 1/4	3 1/8	1	2.25	A	41A23	3/8	.72
24	41B24	4.100	B	5/8	2 1/2	3 1/4	1	2.33	A	41A24	3/8	.82
25	41B25	4.260	B	5/8	2 3/4	3 1/2	1	2.46	A	41A25	3/8	.88
26	41B26	4.420	B	5/8	2 3/4	3 3/4	1	2.50	A	41A26	3/8	.94
27	41B27	4.580	B	5/8	2 3/4	3 3/4	1	2.56	A	41A27	3/8	1.00
28	41B28	4.740	B	5/8	2 3/4	3 3/4	1	2.64	A	41A28	3/8	1.08
30	41B30	5.060	B	5/8	2 3/4	3 3/4	1	2.80	A	41A30	3/8	1.20
32	41B32	5.380	B	5/8	2 3/4	3 3/4	1	2.96	A	41A32	3/8	1.44
35	41B35	5.860	B	5/8	2 3/4	3 3/4	1	3.12	A	41A35	3/8	1.70
36	41B36	6.020	B	5/8	2 3/4	3 3/4	1	3.32	A	41A36	3/8	1.84
40	41B40	6.650	B	5/8	2 3/4	3 3/4	1 1/16	4.06	A	41A40	3/8	2.22
42	41B42	6.970	B	3/4	2 3/4	3 3/4	1 1/16	4.10	A	41A42	3/8	2.50
45	41B45	7.450	B	3/4	2 3/4	3 3/4	1 1/16	4.18	A	41A45	3/8	2.52
48	41B48	7.930	B	3/4	2 3/4	3 3/4	1 1/16	4.92	A	41A48	3/8	2.92
54	41B54	8.880	B	3/4	2 3/4	3 3/4	1 1/16	5.68	A	41A54	3/8	3.54
60	41B60	9.840	B	3/4	2 3/4	3 3/4	1 1/16	6.78	A	41A60	3/8	4.60
70	41B70	11.430	B	3/4	2 3/4	4	1 1/16	9.54	A	41A70	3/8	6.22
72	41B72	11.750	B	3/4	2 3/4	4	1 1/16	9.64	A	41A72	3/8	6.32
80	41B80	13.030	B	3/4	2 3/4	4	1 1/16	11.54	A	41A80	3/8	8.46
84	41B84	13.660	B	3/4	2 3/4	4	1 1/16	12.20	A	41A84	3/8	9.12
96	41B96	15.570	B	1	2 3/4	4	1 1/16	14.86	A	41A96	3/8	11.84
112	41B112	18.120	B	1	2 3/4	4	1 1/16	19.16	A	41A112	3/8	15.84

* Has recessed groove in hub for chain clearance.

Maximum bores shown will accommodate standard keyseat and setscrew over keyseat.
Slightly larger bores are possible with no keyseat, shallow keyseat, or setscrew at angle to keyseat.

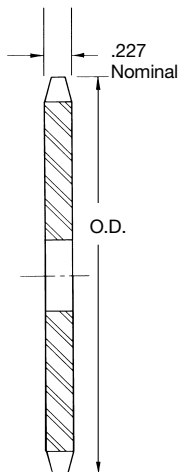

TYPE A

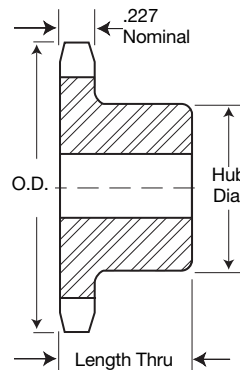

TYPE B

Single-Taper Bushed

No. Teeth	Catalog Number	Bushing	Diameters		Max. Bore	Dimensions			Weight (Approx.)	
			Outside Diameter	Pitch Diameter		L	C	Type	Rim Only	Bushing Only
14	41BTB14	1008	2.49	2.247	1	7/8	1 1/8*	B	.4	.3
15	41BTB15	1008	2.65	2.405	1	7/8	1 1/8	B	.5	.3
16	41BTB16	1008	2.81	2.503	1	7/8	2	B	.6	.3
17	41BTB17	1210	2.97	2.721	1 1/4	1	2 3/8*	B	.7	.6
18	41BTB18	1210	3.14	2.879	1 1/4	1	2 3/8	B	.9	.6
19	41BTB19	1210	3.30	3.038	1 1/4	1	2 1/2	B	1.1	.6
20	41BTB20	1610	3.46	3.196	1 1/2	1	2 3/8*	B	1.1	.9
21	41BTB21	1610	3.62	3.355	1 1/2	1	3*	B	1.2	.9
22	41BTB22	1610	3.78	3.513	1 1/2	1	3	B	1.3	.9
23	41BTB23	1610	3.94	3.672	1 1/2	1	3	B	1.4	.9
24	41BTB24	1610	4.10	3.831	1 1/2	1	3	B	1.4	.9
25	41BTB25	1610	4.26	3.989	1 1/2	1	3	B	1.5	.9
26	41BTB26	1610	4.42	4.148	1 1/2	1	3	B	1.5	.9
28	41BTB28	1610	4.74	4.466	1 1/2	1	3	B	1.7	.9
30	41BTB30	1610	5.06	4.783	1 1/2	1	3	B	1.8	.9
32	41BTB32	1610	5.38	5.101	1 1/2	1	3	B	1.9	.9
35	41BTB35	1610	5.86	5.578	1 1/2	1	3	B	2.3	.9
36	41BTB36	1610	6.02	5.737	1 1/2	1	3	B	2.4	.9
40	41BTB40	1610	6.65	6.373	1 1/2	1	3	B	2.7	.9
45	41BTB45	1610	7.45	7.168	1 1/2	1	3	B	3.5	.9
48	41BTB48	1610	7.93	7.645	1 1/2	1	3	B	4.1	.9
54	41BTB54	1610	8.88	8.599	1 1/2	1	3	B	4.9	.9
60	41BTB60	1610	9.84	9.554	1 1/2	1	3	B	5.7	.9
70	41BTB70	1610	11.43	11.145	1 1/2	1	3	B	7.4	.9
72	41BTB72	1610	11.75	11.463	1 1/2	1	3	B	8.2	.9
80	41BTB80	1610	13.03	12.736	1 1/2	1	3	B	9.6	.9
96	41BTB96	1610	15.57	15.282	1 1/2	1	3	B	13.1	.9

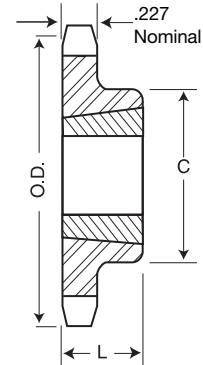

**TAPER BUSHED
TYPE B**



* Has recessed groove in hub for chain clearance.

Single-Type QD

No. Teeth	Catalog Number	Bushing	Diameters		Type	Max. Bore	Dimensions							Weight (Approx.)	
			Outside Diameter	Pitch Diameter			L ₁	L ₂	C	Y	G	X	T	With Hub	Rim Only
15	41JA15	JA	2.650	2.405	B	1 1/4	1 1/8	1 1/8	2 1/16	9/64	25/64	5/8	.227	1.22	.32
16	41JA16	JA	2.810	2.563	B									1.30	.40
17	41JA17	JA	2.980	2.721	B									1.40	.50
18	41JA18	JA	3.140	2.879	B									1.50	.60
19	41JA19	JA	3.300	3.038	B	1 1/4	1 1/8	1 1/8	2 1/16	9/64	25/64	5/8	.227	1.58	.68
20	41SH20	SH	3.460	3.196	B	1 1/4	1 1/8	1 1/8	2 1/16	1 1/2	37/64	13/16	.227	1.78	.78
21	41SH21	SH	3.620	3.355	B									1.82	.82
22	41SH22	SH	3.780	3.513	B									2.06	1.06
23	41SH23	SH	3.940	3.672	B									2.14	1.14
24	41SH24	SH	4.100	3.831	B									2.16	1.16
25	41SH25	SH	4.260	3.989	B									2.22	1.22
26	41SH26	SH	4.420	4.148	B									2.26	1.26
27	41SH27	SH	4.580	4.307	B									2.40	1.40
28	41SH28	SH	4.740	4.466	B									2.54	1.54
30	41SH30	SH	5.060	4.783	B									2.58	1.58
32	41SH32	SH	5.380	5.101	B									2.68	1.68
35	41SH35	SH	5.860	5.578	B	1 1/4	1 1/8	1 1/8	2 1/16	1 1/2	37/64	13/16	.227	3.46	2.47
36	41SDS36	SDS	6.020	5.737	B	2	1 1/2	1 1/2	3 3/16	1 3/2	1 1/2	3/4	.227	2.92	1.92
40	41SDS40	SDS	6.650	6.373	B									3.32	2.32
42	41SDS42	SDS	6.970	6.691	B									3.44	2.44
45	41SDS45	SDS	7.450	7.168	B									3.76	2.76
48	41SDS48	SDS	7.930	7.645	B									4.36	3.36
54	41SDS54	SDS	8.890	8.599	B									4.98	3.98
60	41SDS60	SDS	9.840	9.554	B	2	1 1/2	1 1/2	3 3/16	1 3/2	1 1/2	3/4	.227	6.54	5.54
70	41SK70	SK	11.430	11.145	B	2 1/2	2 1/2	2 1/2	3 3/8	1 3/4	1 1/2	1 1/4	.227	9.42	7.42
72	41SK72	SK	11.750	11.463	B									10.02	8.02
80	41SK80	SK	13.030	12.736	B									11.64	9.64
84	41SK84	SK	13.660	13.372	B									12.40	10.40
96	41SK96	SK	15.570	15.281	B									14.82	12.82
112	41SK112	SK	18.120	17.828	B	2 1/2	2 1/2	2 1/2	3 3/8	1 3/4	1 1/2	1 1/4	.227	19.28	17.28

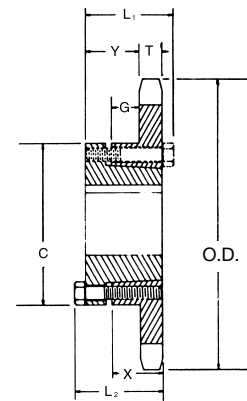

"QD" — TYPE B



No. 40

1/2" Pitch

All Steel Stock Sprockets

Martin

Single-Type "BS"— 2 Setscrews — Bored-To-Size

No. Teeth	Catalog Number	Outside Diameter	Length Thru Bore	Weight Lbs. (Approx.)	Stock Finished Bores Includes Keyway and 2 Setscrews
9	40BS9	1.670	3/8	.16	*1/2 - 3/8
10	40BS10	1.840	3/8	.24	*1/2 - 3/8 - 3/8
11	40BS11	2.000	3/8	.28	*1/2 - 3/8 - 3/8 - 3/8
12	40BS12	2.170	3/8	.34	*1/2 - 3/8 - 3/8 - 3/8 - 1
13	40BS13	2.330	3/8	.45	*1/2 - 3/8 - 3/8 - 3/8 - 1
14	40BS14	2.490	3/8	.51	*1/2 - 3/8 - 3/8 - 3/8 - 1 - 1/16
15	40BS15	2.650	3/8	.53	*1/2 - 3/8 - 3/8 - 3/8 - 1 - 1/16 - 1/16 - 1/16
16	40BS16	2.810	3/8	.66	3/8 - 3/8 - 3/8 - 1 - 1/16 - 1/16 - 1/16
17	40BS17	2.970	1	.88	3/8 - 3/8 - 3/8 - 1 - 1/16 - 1/16 - 1/16
18	40BS18	3.140	1	1.03	3/8 - 3/8 - 3/8 - 1 - 1/16 - 1/16 - 1/16 - 1/16 - 1/16 - 1/16
19	40BS19	3.300	1	1.17	3/8 - 3/8 - 3/8 - 1 - 1/16 - 1/16 - 1/16 - 1/16 - 1/16 - 1/16
20	40BS20	3.460	1	1.33	3/8 - 3/8 - 3/8 - 1 - 1/16 - 1/16 - 1/16 - 1/16 - 1/16 - 1/16
21	40BS21	3.620	1	1.53	3/8 - 3/8 - 3/8 - 1 - 1/16 - 1/16 - 1/16 - 1/16 - 1/16 - 1/16
22	40BS22	3.780	1	1.66	3/8 - 3/8 - 3/8 - 1 - 1/16 - 1/16 - 1/16 - 1/16 - 1/16 - 1/16
23	40BS23	3.940	1	1.92	3/8 - 3/8 - 3/8 - 1 - 1/16 - 1/16 - 1/16 - 1/16 - 1/16 - 1/16
24	40BS24	4.100	1	2.10	3/8 - 3/8 - 3/8 - 1 - 1/16 - 1/16 - 1/16 - 1/16 - 1/16 - 1/16
25	40BS25	4.260	1	2.22	3/8 - 3/8 - 3/8 - 1 - 1/16 - 1/16 - 1/16 - 1/16 - 1/16 - 1/16
26	40BS26	4.420	1	2.34	3/8 - 3/8 - 3/8 - 1 - 1/16 - 1/16 - 1/16 - 1/16 - 1/16 - 1/16
27	40BS27	4.580	1	2.42	3/8 - 3/8 - 3/8 - 1 - 1/16 - 1/16 - 1/16 - 1/16 - 1/16 - 1/16
28	40BS28	4.740	1	2.50	3/8 - 3/8 - 3/8 - 1 - 1/16 - 1/16 - 1/16 - 1/16 - 1/16 - 1/16
29	40BS29	4.900	1	2.60	3/8 - 3/8 - 3/8 - 1 - 1/16 - 1/16 - 1/16 - 1/16 - 1/16 - 1/16
30	40BS30	5.060	1	2.70	3/8 - 3/8 - 3/8 - 1 - 1/16 - 1/16 - 1/16 - 1/16 - 1/16 - 1/16
31	40BS31	5.220	1	2.88	3/8 - 3/8 - 3/8 - 1 - 1/16 - 1/16 - 1/16 - 1/16 - 1/16 - 1/16
32	40BS32	5.380	1	3.00	3/8 - 3/8 - 3/8 - 1 - 1/16 - 1/16 - 1/16 - 1/16 - 1/16 - 1/16
33	40BS33	5.540	1	3.03	3/8 - 3/8 - 3/8 - 1 - 1/16 - 1/16 - 1/16 - 1/16 - 1/16 - 1/16
34	40BS34	5.700	1	3.11	3/8 - 3/8 - 3/8 - 1 - 1/16 - 1/16 - 1/16 - 1/16 - 1/16 - 1/16
35	40BS35	5.860	1	3.20	3/8 - 3/8 - 3/8 - 1 - 1/16 - 1/16 - 1/16 - 1/16 - 1/16 - 1/16
36	40BS36	6.020	1	3.39	3/8 - 3/8 - 3/8 - 1 - 1/16 - 1/16 - 1/16 - 1/16 - 1/16 - 1/16
37	40BS37	6.170	1	3.45	3/8 - 3/8 - 3/8 - 1 - 1/16 - 1/16 - 1/16 - 1/16 - 1/16 - 1/16
38	40BS38	6.330	1	3.50	3/8 - 3/8 - 3/8 - 1 - 1/16 - 1/16 - 1/16 - 1/16 - 1/16 - 1/16
39	40BS39	6.490	1	4.00	3/8 - 3/8 - 3/8 - 1 - 1/16 - 1/16 - 1/16 - 1/16 - 1/16 - 1/16
40	40BS40	6.650	1 1/8	4.28	3/8 - 3/8 - 3/8 - 1 - 1/16 - 1/16 - 1/16 - 1/16 - 1/16 - 1/16
41	40BS41	6.810	1 1/8	4.58	3/8 - 3/8 - 3/8 - 1 - 1/16 - 1/16 - 1/16 - 1/16 - 1/16 - 1/16
42	40BS42	6.970	1 1/8	4.64	3/8 - 3/8 - 3/8 - 1 - 1/16 - 1/16 - 1/16 - 1/16 - 1/16 - 1/16
43	40BS43	7.130	1 1/8	4.80	3/8 - 3/8 - 3/8 - 1 - 1/16 - 1/16 - 1/16 - 1/16 - 1/16 - 1/16
44	40BS44	7.290	1 1/8	4.96	3/8 - 3/8 - 3/8 - 1 - 1/16 - 1/16 - 1/16 - 1/16 - 1/16 - 1/16
45	40BS45	7.450	1 1/8	5.06	3/8 - 3/8 - 3/8 - 1 - 1/16 - 1/16 - 1/16 - 1/16 - 1/16 - 1/16
46	40BS46	7.610	1 1/8	5.19	3/8 - 3/8 - 3/8 - 1 - 1/16 - 1/16 - 1/16 - 1/16 - 1/16 - 1/16
47	40BS47	7.770	1 1/8	5.26	3/8 - 3/8 - 3/8 - 1 - 1/16 - 1/16 - 1/16 - 1/16 - 1/16 - 1/16
48	40BS48	7.930	1 1/8	5.66	3/8 - 3/8 - 3/8 - 1 - 1/16 - 1/16 - 1/16 - 1/16 - 1/16 - 1/16
49	40BS49	8.090	1 1/8	5.72	3/8 - 3/8 - 3/8 - 1 - 1/16 - 1/16 - 1/16 - 1/16 - 1/16 - 1/16
50	40BS50	8.250	1 1/8	5.78	3/8 - 3/8 - 3/8 - 1 - 1/16 - 1/16 - 1/16 - 1/16 - 1/16 - 1/16
51	40BS51	8.410	1 1/8	5.90	3/8 - 3/8 - 3/8 - 1 - 1/16 - 1/16 - 1/16 - 1/16 - 1/16 - 1/16
52	40BS52	8.570	1 1/8	5.94	3/8 - 3/8 - 3/8 - 1 - 1/16 - 1/16 - 1/16 - 1/16 - 1/16 - 1/16
53	40BS53	8.730	1 1/8	6.12	3/8 - 3/8 - 3/8 - 1 - 1/16 - 1/16 - 1/16 - 1/16 - 1/16 - 1/16
54	40BS54	8.880	1 1/8	6.24	3/8 - 3/8 - 3/8 - 1 - 1/16 - 1/16 - 1/16 - 1/16 - 1/16 - 1/16
55	40BS55	9.040	1 1/8	6.66	3/8 - 3/8 - 3/8 - 1 - 1/16 - 1/16 - 1/16 - 1/16 - 1/16 - 1/16
56	40BS56	9.200	1 1/8	6.71	3/8 - 3/8 - 3/8 - 1 - 1/16 - 1/16 - 1/16 - 1/16 - 1/16 - 1/16
57	40BS57	9.360	1 1/8	6.94	3/8 - 3/8 - 3/8 - 1 - 1/16 - 1/16 - 1/16 - 1/16 - 1/16 - 1/16
58	40BS58	9.520	1 1/8	7.17	3/8 - 3/8 - 3/8 - 1 - 1/16 - 1/16 - 1/16 - 1/16 - 1/16 - 1/16
59	40BS59	9.680	1 1/8	7.38	3/8 - 3/8 - 3/8 - 1 - 1/16 - 1/16 - 1/16 - 1/16 - 1/16 - 1/16
60	40BS60	9.840	1 1/8	7.68	3/8 - 3/8 - 3/8 - 1 - 1/16 - 1/16 - 1/16 - 1/16 - 1/16 - 1/16
70	40BS70	11.430	1 1/2	10.80	3/8 - 3/8 - 3/8 - 1 - 1/16 - 1/16 - 1/16 - 1/16 - 1/16 - 1/16
72	40BS72	11.750	1 1/2	11.30	3/8 - 3/8 - 3/8 - 1 - 1/16 - 1/16 - 1/16 - 1/16 - 1/16 - 1/16
80	40BS80	13.030	1 1/2	13.20	3/8 - 3/8 - 3/8 - 1 - 1/16 - 1/16 - 1/16 - 1/16 - 1/16 - 1/16
84	40BS84	13.660	1 1/2	13.84	3/8 - 3/8 - 3/8 - 1 - 1/16 - 1/16 - 1/16 - 1/16 - 1/16 - 1/16
96	40BS96	15.570	1 1/2	17.44	3/8 - 3/8 - 3/8 - 1 - 1/16 - 1/16 - 1/16 - 1/16 - 1/16 - 1/16
112	40BS112	18.120	1 1/2	22.45	3/8 - 3/8 - 3/8 - 1 - 1/16 - 1/16 - 1/16 - 1/16 - 1/16 - 1/16



BORED-TO-SIZE

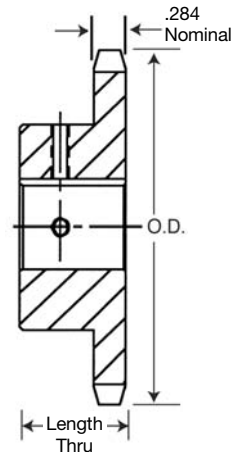

TYPE BS

*Indicates no keyway.
 (2) 1/4" setscrews only.
 Hub diameters vary to suit different bore sizes.

NOTE: KEYWAY IS ON CENTER LINE OF TOOTH.

Martin

All Steel Stock Sprockets

No. 40 1/2" Pitch



No. 40-Hardened Teeth — 2 Setscrews — Bored-To-Size

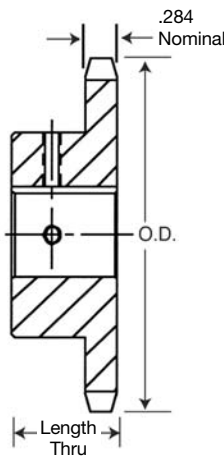

TYPE BS

No. Teeth	Catalog Number	Outside Diameter	Length Thru Bore	Weight Lbs. (Approx.)	Stock Finished Bores Includes Keyway and 2 Setscrews
9	40BS9HT	1.670	3/8	.16	1/2 - 3/8
10	40BS10HT	1.840	3/8	.24	1/2 - 5/8 - 3/4
11	40BS11HT	2.000	3/8	.28	1/2 - 3/4 - 5/8 - 3/4
12	40BS12HT	2.170	3/8	.34	1/2 - 3/4 - 5/8 - 3/4 - 1
13	40BS13HT	2.330	3/8	.45	1/2 - 5/8 - 3/4 - 3/4 - 1
14	40BS14HT	2.490	3/8	.51	1/2 - 3/4 - 5/8 - 3/4 - 1 - 1 1/8
15	40BS15HT	2.650	3/8	.53	1/2 - 5/8 - 3/4 - 3/4 - 1 - 1 1/8 - 1 1/8 - 1 1/8 - 1 1/8
16	40BS16HT	2.810	3/8	.66	3/4 - 3/4 - 3/4 - 1 - 1 1/8 - 1 1/8 - 1 1/8 - 1 1/8
17	40BS17HT	2.970	1	.88	3/4 - 3/4 - 3/4 - 1 - 1 1/8 - 1 1/8 - 1 1/8
18	40BS18HT	3.140	1	1.03	3/4 - 3/4 - 3/4 - 1 - 1 1/8 - 1 1/8 - 1 1/8 - 1 1/8 - 1 1/8 - 1 1/8
19	40BS19HT	2.300	1	1.17	3/4 - 3/4 - 3/4 - 1 - 1 1/8 - 1 1/8 - 1 1/8 - 1 1/8 - 1 1/8 - 1 1/8
20	40BS20HT	3.460	1	1.33	3/4 - 3/4 - 3/4 - 1 - 1 1/8 - 1 1/8 - 1 1/8 - 1 1/8 - 1 1/8 - 1 1/8
21	40BS21HT	3.620	1	1.53	3/4 - 3/4 - 3/4 - 1 - 1 1/8 - 1 1/8 - 1 1/8 - 1 1/8 - 1 1/8 - 1 1/8
22	40BS22HT	3.780	1	1.66	3/4 - 3/4 - 3/4 - 1 - 1 1/8 - 1 1/8 - 1 1/8 - 1 1/8 - 1 1/8 - 1 1/8
23	40BS23HT	3.940	1	1.92	3/4 - 3/4 - 3/4 - 1 - 1 1/8 - 1 1/8 - 1 1/8 - 1 1/8 - 1 1/8 - 1 1/8
24	40BS24HT	4.100	1	2.10	3/4 - 3/4 - 3/4 - 1 - 1 1/8 - 1 1/8 - 1 1/8 - 1 1/8 - 1 1/8 - 1 1/8
25	40BS25HT	4.260	1	2.22	3/4 - 3/4 - 3/4 - 1 - 1 1/8 - 1 1/8 - 1 1/8 - 1 1/8 - 1 1/8 - 1 1/8
26	40BS26HT	4.420	1	2.34	3/4 - 3/4 - 3/4 - 1 - 1 1/8 - 1 1/8 - 1 1/8 - 1 1/8 - 1 1/8 - 1 1/8
28	40BS28HT	4.740	1	2.50	3/4 - 3/4 - 3/4 - 1 - 1 1/8 - 1 1/8 - 1 1/8 - 1 1/8 - 1 1/8 - 1 1/8
30	40BS30HT	5.060	1	2.70	3/4 - 3/4 - 3/4 - 1 - 1 1/8 - 1 1/8 - 1 1/8 - 1 1/8 - 1 1/8 - 1 1/8

*Indicates no keyway. (2) 1/4" setscrews only in 1/2" & 3/8" bore at 90°.
NOTE: KEYWAY IS ON CENTER LINE OF TOOTH.

Martin stock hardened teeth sprockets afford longer chain and sprocket life. Hardened teeth on the smaller sprocket of a roller chain drive are recommended if the drive ratio is four to one or greater or if the smaller sprocket has 24 teeth or less and is running at a speed of over 600 R.P.M.

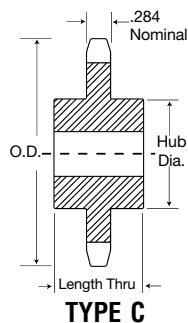

TYPE C

Single-Type C — Steel

No. Teeth	Catalog Number	Outside Diameter	Bore (inches)		Hub (inches)		Weight Lbs. (Approx.)
			Stock	Rec. Max.	Diameter	Length	
12	40C12	2.170	1/2	1	1 3/16*	1 1/2	.75
13	40C13	2.330	1/2	1 1/8	1 3/8	1 1/2	.94
14	40C14	2.490	1/2	1 1/8	1 11/16	1 1/2	.91
15	40C15	2.650	1/2	1 1/4	1 7/8	1 1/2	1.19
16	40C16	2.810	1/2	1 1/2	2	1 1/2	1.34
17	40C17	2.970	3/4	1 1/2	2 1/8	1 1/2	1.5
18	40C18	3.140	3/4	1 1/2	2 1/8	1 1/2	1.8

* Has recessed groove in hub for chain clearance.

SPROCKETS

No. 40

1/2" Pitch

All Steel Stock Sprockets

Martin



SPROCKETS

Double Single-Type A — Steel

No. Teeth	Catalog Number	Diameters		Type	Min. Bore	Max. Bore	Dimensions				Wt. (Approx.)
		Outside Diameter	Pitch Diameter				L	C	E	w Nom.	
15	DS40A15	2.650	2.405	A	1/2	1 1/4	1 13/32	1 1/8	1 13/16	.284	1.2
16	DS40A16	2.810	2.563	A	1/2	1 1/4	1 13/32	1 1/8	2	.284	1.4
17	DS40A17	2.980	2.721	A	1/2	1 5/16	1 13/32	1 1/8	2 1/2	.284	1.6
18	DS40A18	3.140	2.879	A	1/2	1 1/2	1 13/32	1 1/8	2 5/16	.284	1.8
19	DS40A19	3.300	3.038	A	5/8	1 7/16	1 13/32	1 1/8	2 1/2	.284	2.2
20	DS40A20	3.460	3.196	A	5/8	1 3/4	1 13/32	1 1/8	2 5/8	.284	2.6
21	DS40A21	3.620	3.355	A	5/8	1 3/4	1 13/32	1 1/8	2 25/32	.284	2.9
22	DS40A22	3.780	3.513	A	5/8	1 9/16	1 13/32	1 1/8	2 19/16	.284	3.0
23	DS40A23	3.940	3.672	A	5/8	2 1/16	1 13/32	1 1/8	3 3/32	.284	3.5
24	DS40A24	4.100	3.831	A	5/8	2 1/4	1 13/32	1 1/8	3 17/64	.284	4.0
25	DS40A25	4.260	3.989	A	5/8	2 1/2	1 13/32	1 1/8	3 1/16	.284	4.5

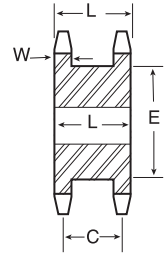

TYPE A

Double Single-Taper Bushed — Steel

No. Teeth	Catalog Number	Bushing Size	Diameters		Min. Bore	Max. Bore	Type	Dimensions					Wt. Rim Only
			Outside Diameter	Pitch Diameter				L ₁	C	E	L ₂	w Nom.	
18	DS40ATB18H	1215	3.140	2.879	1/2	1 1/4	A	1 13/32	1 1/8	2 5/16	1 1/2	.284	1.0
19	DS40ATB19H	1215	3.300	3.038	1/2	1 1/4	A	1 13/32	1 1/8	2 1/2	1 1/2	.284	1.1
20	DS40ATB20H	1215	3.460	3.196	1/2	1 1/4	A	1 13/32	1 1/8	2 3/8	1 1/2	.284	1.3
21	DS40ATB21H	1615	3.620	3.355	1/2	1 1/2	A	1 13/32	1 1/8	2 25/32	1 1/2	.284	1.3
23	DS40ATB23H	1615	3.940	3.672	1/2	1 1/2	A	1 13/32	1 1/8	3 3/32	1 1/2	.284	1.5
24	DS40ATB24H	1615	4.100	3.831	1/2	1 1/2	A	1 13/32	1 1/8	3 17/64	1 1/2	.284	1.7

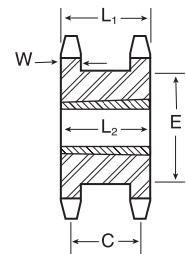

TAPER BUSH
TYPE A

Double Single - MST[®] — Steel

No. Teeth	Catalog Number	Bushing Size	Diameters		Min. Bore	Max. Bore	Type	Dimensions					Wt. Rim Only
			Outside Diameter	Pitch Diameter				L ₁	C	E	L ₂	w Nom.	
19	DS40H19H	H	3.300	3.038	5/8	1 1/2	BH	1 13/32	1 1/8	2 1/2	2 1/2	.284	1.5
21	DS40H21H	H	3.620	3.355	5/8	1 1/2	BH	1 13/32	1 1/8	2 25/32	2 1/2	.284	2
23	DS40P23H	P1	3.940	3.672	1/2	1 3/4	B	1 13/32	1 1/8	3 3/32	2 3/4	.284	2.3
24	DS40P24H	P1	4.100	3.831	1/2	1 3/4	B	1 13/32	1 1/8	3 17/64	2 3/4	.284	2.5

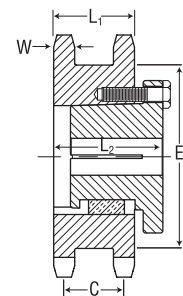

MST
TYPE B

Single-Type B — Stainless

Single-Type A

No. Teeth	Catalog Number	Outside Diameter	Type	Bore (inches)		Hub (inches)		Weight Lbs. (Approx.)	Type	Catalog Number	Stock Bore	Weight Lbs. (Approx.)
				Stock	Rec. Max.	Diameter	Length Thru					
10	40B10SS	1.840	B	1/2	3/4	1 1/4*	3/8	.28				
11	40B11SS	2.000	B	1/2	7/8	1 3/8*	3/8	.36				
12	40B12SS	2.170	B	1/2	1 1/8	1 5/8*	3/8	.44				
13	40B13SS	2.33	B	1/2	1 1/8	1 7/8	3/8	.50				
14	40B14SS	2.490	B	1/2	1 1/4	1 7/8	3/8	.60				
15	40B15SS	2.650	B	1/2	1 1/2	1 7/8	3/8	.68				
16	40B16SS	2.810	B	5/8	1 3/4	2	3/8	.82				
17	40B17SS	2.980	B	5/8	1 7/8	2 1/8	1	1.06				
18	40B18SS	3.140	B	5/8	1 7/8	2 1/8	1	1.24				
19	40B19SS	3.300	B	5/8	1 3/4	2 1/2	1	1.42				
20	40B20SS	3.460	B	5/8	1 7/8	2 3/8	1	1.60				
21	40B21SS	3.620	B	5/8	1 7/8	2 3/8	1	1.68				
22	40B22SS	3.780	B	5/8	1 7/8	2 3/8	1	1.81				
23	40B23SS	3.940	B	5/8	2	3	1	2.18				
24	40B24SS	4.100	B	5/8	2 1/4	3 1/4	1	2.20				
25	40B25SS	4.260	B	5/8	2 1/4	3 1/4	1	1.84				
26	40B26SS	4.420	B	5/8	2 1/4	3 1/4	1	2.40	A	40A26SS	1 9/32	1.31
28	40B28SS	4.740	B	5/8	2 1/4	3 1/4	1	2.75	A	40A28SS	1 9/32	1.35
30	40B30SS	5.060	B	5/8	2 1/4	3 1/4	1	2.88	A	40A30SS	1 9/32	1.39
35	40B35SS	5.860	B	5/8	2 1/4	3 1/4	1	3.32	A	40A35SS	1 9/32	1.92
40	40B40SS	6.650	B	3/4	2 3/8	3 1/2	1	4.28	A	40A40SS	2 3/32	2.36
45	40B45SS	7.450	B	3/4	2 3/8	3 1/2	1	4.68	A	40A45SS	2 3/32	3.13
60	40B60SS	9.840	B	3/4	2 3/8	3 1/2	1	7.00	A	40A60SS	2 3/32	5.50

* Has recessed groove in hub for chain clearance.

Maximum bores shown will accommodate standard keyseat and setscrew over keyseat. Slightly larger bores are possible with no keyseat, shallow keyseat, or setscrew at angle to keyseat.

Sprockets altered at factory (rebored with keyway and setscrew added) will be supplied with stainless setscrew.



STAINLESS STEEL

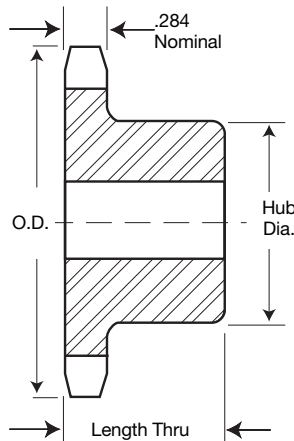

TYPE B

Alteration Charges

See current discount sheet for alteration charges.

No. 40

1/2" Pitch

All Steel Stock Sprockets

Martin

Single-Type B

Single-Type A

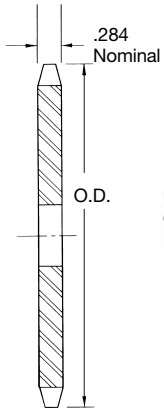

TYPE A

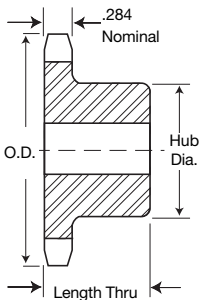

TYPE B

No. Teeth	Catalog Number	Outside Diameter	Type	Bore (inches)		Hub (inches)		Weight Lbs (Approx.)	Type	Catalog Number	Stock Bore	Weight Lbs. (Approx.)
				Stock	Rec. Max.	Diameter	Length Thru					
8	40B8	1.510	B	1/2	1/2	3/32*	7/8	.18				
9	40B9	1.670	B	1/2	5/8	1 1/16*	7/8	.20				
10	40B10	1.840	B	1/2	3/4	1 1/8*	7/8	.27				
11	40B11	2.000	B	1/2	7/8	1 1/4*	7/8	.35				
12	40B12	2.170	B	1/2	1	1 1/8*	7/8	.45	A	40A12	1/2	.18
13	40B13	2.330	B	1/2	1 1/8	1 1/8	7/8	.50	A	40A13	1/2	.22
14	40B14	2.490	B	1/2	1 1/4	1 1/8	7/8	.59	A	40A14	1/2	.26
15	40B15	2.650	B	1/2	1 1/2	1 1/8	7/8	.70	A	40A15	1/2	.30
16	40B16	2.810	B	5/8	1 1/8	2	1	.79	A	40A16	5/8	.34
17	40B17	2.980	B	5/8	1 1/4	2 1/8	1	1.04	A	40A17	5/8	.36
18	40B18	3.140	B	5/8	1 1/2	2 1/8	1	1.22	A	40A18	5/8	.44
19	40B19	3.300	B	5/8	1 3/4	2 1/2	1	1.43	A	40A19	5/8	.46
20	40B20	3.460	B	5/8	1 3/4	2 3/4	1	1.56	A	40A20	5/8	.56
21	40B21	3.620	B	5/8	1 3/4	2 3/4	1	1.73	A	40A21	5/8	.58
22	40B22	3.780	B	5/8	1 3/4	2 3/4	1	1.96	A	40A22	5/8	.66
23	40B23	3.940	B	5/8	2	3	1	2.13	A	40A23	5/8	.72
24	40B24	4.100	B	5/8	2 1/4	3 1/4	1	2.41	A	40A24	5/8	.82
25	40B25	4.260	B	5/8	2 1/4	3 1/4	1	2.54	A	40A25	5/8	.88
26	40B26	4.420	B	5/8	2 1/4	3 1/4	1	2.58	A	40A26	5/8	.94
27	40B27	4.580	B	5/8	2 1/4	3 1/4	1	2.66	A	40A27	5/8	.98
28	40B28	4.740	B	5/8	2 1/4	3 1/4	1	2.73	A	40A28	5/8	1.10
29	40B29	4.900	B	5/8	2 1/4	3 1/4	1	2.80	A	40A29	19/32	1.22
30	40B30	5.060	B	5/8	2 1/4	3 1/4	1	2.98	A	40A30	19/32	1.26
31	40B31	5.220	B	5/8	2 1/4	3 1/4	1	3.10	A	40A31	19/32	1.40
32	40B32	5.380	B	5/8	2 1/4	3 1/4	1	3.16	A	40A32	19/32	1.48
33	40B33	5.540	B	5/8	2 1/4	3 1/4	1	3.22	A	40A33	19/32	1.56
34	40B34	5.700	B	5/8	2 1/4	3 1/4	1	3.30	A	40A34	19/32	1.64
35	40B35	5.860	B	5/8	2 1/4	3 1/4	1	3.46	A	40A35	19/32	1.70
36	40B36	6.020	B	5/8	2 1/4	3 1/4	1	3.58	A	40A36	19/32	1.84
37	40B37	6.180	B	5/8	2 1/4	3 1/4	1	3.62	A	40A37	19/32	1.92
38	40B38	6.330	B	5/8	2 1/4	3 1/4	1	3.70	A	40A38	19/32	2.00
39	40B39	6.490	B	5/8	2 1/4	3 1/4	1	3.76	A	40A39	19/32	2.02
40	40B40	6.650	B	5/8	2 1/2	3 1/2	1 1/8	4.69	A	40A40	23/32	2.22
41	40B41	6.810	B	5/8	2 1/2	3 1/2	1 1/8	4.76	A	40A41	23/32	2.42
42	40B42	6.970	B	5/8	2 1/2	3 1/2	1 1/8	4.82	A	40A42	23/32	2.50
43	40B43	7.130	B	5/8	2 1/2	3 1/2	1 1/8	5.12	A	40A43	23/32	2.80
44	40B44	7.290	B	5/8	2 1/2	3 1/2	1 1/8	5.15	A	40A44	23/32	2.85
45	40B45	7.450	B	5/8	2 1/2	3 1/2	1 1/8	5.30	A	40A45	23/32	3.15
46	40B46	7.610	B	5/8	2 1/2	3 1/2	1 1/8	5.57	A	40A46	23/32	3.26
47	40B47	7.770	B	5/8	2 1/2	3 1/2	1 1/8	5.44	A	40A47	23/32	3.32
48	40B48	7.930	B	5/8	2 1/2	3 1/2	1 1/8	5.84	A	40A48	23/32	3.22
49	40B49	8.090	B	5/8	2 1/2	3 1/2	1 1/8	5.90	A	40A49	23/32	3.44
50	40B50	8.250	B	5/8	2 1/2	3 1/2	1 1/8	5.96	A	40A50	23/32	3.62
51	40B51	8.410	B	5/8	2 1/2	3 1/2	1 1/8	6.08	A	40A51	23/32	3.94
52	40B52	8.570	B	5/8	2 1/2	3 1/2	1 1/8	6.28	A	40A52	23/32	4.08
53	40B53	8.730	B	5/8	2 1/2	3 1/2	1 1/8	6.33	A	40A53	23/32	4.04
54	40B54	8.890	B	5/8	2 1/2	3 1/2	1 1/8	6.42	A	40A54	23/32	4.44
55	40B55	9.040	B	5/8	2 1/2	3 1/2	1 1/8	6.46	A	40A55	23/32	4.54
56	40B56	9.200	B	5/8	2 1/2	3 1/2	1 1/8	6.89	A	40A56	23/32	4.84
57	40B57	9.360	B	5/8	2 1/2	3 1/2	1 1/8	7.02	A	40A57	23/32	5.00
58	40B58	9.520	B	5/8	2 1/2	3 1/2	1 1/8	7.36	A	40A58	23/32	5.12
59	40B59	9.680	B	5/8	2 1/2	3 1/2	1 1/8	7.45	A	40A59	23/32	5.30
60	40B60	9.840	B	5/8	2 1/2	3 1/2	1 1/8	7.86	A	40A60	23/32	5.48
70	40B70	11.430	B	5/8	2 1/2	4	1 1/4	11.00	A	40A70	23/32	7.24
72	40B72	11.750	B	5/8	2 1/2	4	1 1/4	11.50	A	40A72	23/32	7.74
80	40B80	13.030	B	5/8	2 1/2	4	1 1/4	13.40	A	40A80	23/32	10.20
84	40B84	13.660	B	5/8	2 1/2	4	1 1/4	14.04	A	40A84	23/32	10.07
96	40B96	15.570	B	1	2 1/2	4	1 1/4	17.56	A	40A96	1 1/8	12.15
112	40B112	18.120	B	1	2 1/2	4	1 1/4	22.56	A	40A112	1 1/8	20.00

* Has recessed groove in hub for chain clearance.

Maximum bores shown will accommodate standard keyseat and setscrew over keyseat. Slightly larger bores are possible with no keyseat, shallow keyseat, or setscrew at angle to keyseat.

Alteration Charges

See current discount sheet for alteration charges.

Martin

All Steel Stock Sprockets

No. 40 1/2" Pitch

Single-Type QD With Hardened Teeth

No. Teeth	Catalog Number
15	40JA15H
16	40JA16H
17	40JA17H
18	40JA18H
19	40JA19H
20	40SH20H
21	40SH21H
22	40SH22H
23	40SH23H
24	40SH24H
25	40SH25H
26	40SH26H
27	40SH27H
28	40SH28H
30	40SH30H

**SABER
TOOTH®**

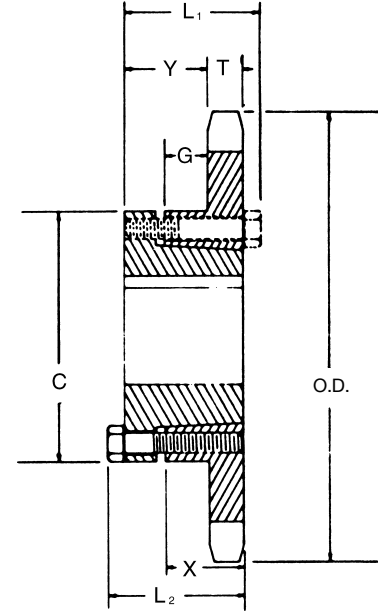

QD — TYPE B

SPROCKETS

Single-Type QD

No. Teeth	Catalog Number	Bush- ing	Diameters		Type	Max. Bore	Dimensions							Weight (Approx.)	
			Outside Diameter	Pitch Diameter			L ₁	L ₂	C	Y	G	X	T	With Hub	Rim Only
15	40JA15	JA	2.650	2.405	B	1 1/4	1 1/8	1 1/8	2 1/16	3/32	1 1/32	5/8	.284	1.24	.34
16	40JA16	JA	2.810	2.563	B									1.30	.40
17	40JA17	JA	2.980	2.721	B									1.38	.48
18	40JA18	JA	3.140	2.879	B									1.44	.54
19	40JA19	JA	3.300	3.038	B	1 1/4	1 1/8	1 1/8	2 1/16	3/32	1 1/32	5/8	.284	1.50	.60
20	40SH20	SH	3.460	3.196	B	1 1/4	1 1/8	1 1/8	2 1/16	3/32	1 1/32	13/16	.284	1.76	.76
21	40SH21	SH	3.620	3.355	B									1.84	.84
22	40SH22	SH	3.780	3.513	B									1.92	.92
23	40SH23	SH	3.940	3.672	B									2.14	1.14
24	40SH24	SH	4.100	3.831	B									2.22	1.22
25	40SH25	SH	4.260	3.989	B									2.30	1.30
26	40SH26	SH	4.420	4.148	B									2.44	1.44
27	40SH27	SH	4.580	4.307	B									2.46	1.46
28	40SH28	SH	4.740	4.466	B									2.54	1.54
30	40SH30	SH	5.060	4.783	B									2.72	1.72
32	40SH32	SH	5.380	5.101	B									2.90	1.90
35	40SH35	SH	5.860	5.578	B	1 1/2	1 1/8	1 1/8	3	3/32	1 1/32	15/16	.284	3.22	2.22
36	40SDS36	SDS	6.020	5.737	B	2	1 1/2	1 1/8	3 1/16	1 1/32	15/32	3/4	.284	3.20	2.20
40	40SDS40	SDS	6.650	6.373	B									3.72	2.72
42	40SDS42	SDS	6.970	6.691	B									3.92	2.92
45	40SDS45	SDS	7.450	7.168	B									4.32	3.32
48	40SDS48	SDS	7.930	7.645	B									4.70	3.70
54	40SDS54	SDS	8.890	8.599	B									5.78	4.78
60	40SDS60	SDS	9.840	9.554	B	2	1 1/2	1 1/8	3 3/16	1 1/32	15/32	3/4	.284	6.86	5.86
70	40SK70	SK	11.430	11.145	B	2 1/2	2 1/8	2 1/8	3 3/8	1 1/32	3 1/32	1 1/4	.284	10.68	8.68
72	40SK72	SK	11.750	11.463	B									10.84	8.84
80	40SK80	SK	13.030	12.736	B									13.20	11.20
84	40SK84	SK	13.660	13.372	B									13.56	11.56
96	40SK96	SK	15.570	15.282	B									17.76	15.76
112	40SK112	SK	18.120	17.828	B	2 3/4	2 1/2	2 1/2	3 3/8	1 1/32	3 1/32	1 1/4	.284	22.28	20.28

No. 40

1/2" Pitch

All Steel Stock Sprockets

Martin

Single-Taper Bushed with Hardened Teeth

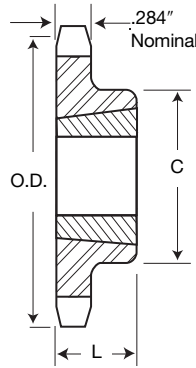

**TAPER BUSHED
TYPE B**

**SABER
TOOTH®**

No. Teeth	Catalog Number
14	40BTB14H
15	40BTB15H
16	40BTB16H
17	40BTB17H
18	40BTB18H
19	40BTB19H
20	40BTB20H
21	40BTB21H
22	40BTB22H
23	40BTB23H
24	40BTB24H
25	40BTB25H
26	40BTB26H
28	40BTB28H
30	40BTB30H

SPROCKETS

Single-Taper Bushed

No. Teeth	Catalog Number	Bushing	Diameters		Max. Bore	Dimensions		Type	Weight (Approx.)	
			Outside Diameter	Pitch Diameter		L	C		Rim Only	Bushing Only
14	40BTB14	1008	2.491	2.247	1	7/8	*1 1/16	B	.3	.3
15	40BTB15	1008	2.652	2.405	1	7/8	1 1/16	B	.4	.3
16	40BTB16	1008	2.814	2.563	1	7/8	1 1/16	B	.5	.3
17	40BTB17	1210	2.975	2.721	1 1/4	1	*2 5/16	B	.5	.3
18	40BTB18	1210	3.135	2.879	1 1/4	1	*2 15/32	B	.6	.6
19	40BTB19	1210	3.296	3.038	1 1/4	1	2 1/2	B	.7	.6
20	40BTB20	1610	3.457	3.196	1 1/2	1	*2 29/32	B	.7	.9
21	40BTB21	1610	3.617	3.355	1 1/2	1	2 29/32	B	.8	.9
22	40BTB22	1610	3.778	3.513	1 1/2	1	2 29/32	B	.9	.9
23	40BTB23	1610	3.938	3.672	1 1/2	1	3 3/32	B	1.0	.9
24	40BTB24	1610	4.098	3.831	1 1/2	1	3 1/4	B	1.4	.9
25	40BTB25	1610	4.258	3.989	1 1/2	1	3 1/2	B	1.5	.9
26	40BTB26	1610	4.418	4.148	1 1/2	1	3 1/2	B	1.7	.9
28	40BTB28	1610	4.738	4.466	1 1/2	1	3 1/2	B	1.8	.9
30	40BTB30	1610	5.057	4.783	1 1/2	1	3 1/2	B	1.9	.9
32	40BTB32	1610	5.377	5.101	1 1/2	1	3 1/2	B	1.9	.9
35	40BTB35	1610	5.855	5.578	1 1/2	1	3 1/2	B	2.3	.9
36	40BTB36	1610	6.015	5.737	1 1/2	1	3	B	2.4	.9
40	40BTB40	1610	6.653	6.373	1 1/2	1	3	B	2.8	.9
42	40BTB42	1610	6.972	6.691	1 1/2	1	3	B	2.9	.9
45	40BTB45	1610	7.451	7.168	1 1/2	1	3	B	3.5	.9
48	40BTB48	1610	7.928	7.645	1 1/2	1	3	B	4.0	.9
54	40BTB54	1610	8.885	8.599	1 1/2	1	3	B	4.9	.9
60	40BTB60	1610	9.841	9.554	1 1/2	1	3	B	6.0	.9
70	40BTB70	2012	11.434	11.145	2	1 1/4	3 9/16	B	8.2	1.7
72	40BTB72	2012	11.752	11.463	2	1 1/4	3 9/16	B	9.0	1.7
80	40BTB80	2012	13.026	12.736	2	1 1/4	3 9/16	B	10.8	1.7
84	40BTB84	2012	13.663	13.372	2	1 1/4	3 9/16	B	11.3	1.7
96	40BTB96	2012	15.573	15.282	2	1 1/4	3 9/16	B	14.6	1.7
112	40BTB112	2517	18.122	17.828	2 1/2	1 1/4	4 1/4	B	20.5	1.7

* Has recessed groove in hub for chain clearance.

Single - MST[®] Sprockets

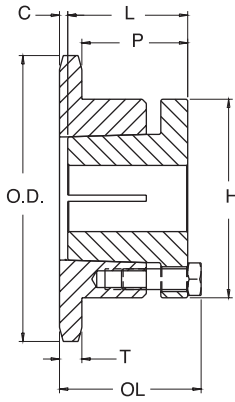

TYPE 3

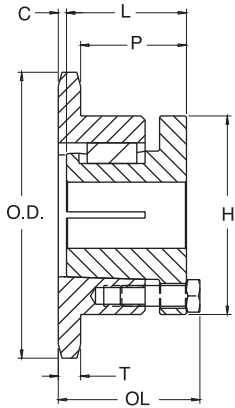

TYPE 4

No. Teeth	Catalog Number	Bush- ing	Diameters		Type	Max. Bore	Dimensions						Weight (Approx.)	
			Outside Dia.	Pitch Dia.			OL	L	C	H	P	T(nom)	With Hub	Rim Only
15	40H15H	H	2.650	2.405	3	1 1/2	1 19/32	1 1/4	5/32	2 1/2	1 1/8	.284	1.3	.5
16	40H16H	H	2.810	2.563	3	1 1/2	1 19/32	1 1/4	5/32	2 1/2	1 1/8	.284	1.4	.6
17	40H17H	H	2.980	2.721	3	1 1/2	1 1/2	1 1/4	1/16	2 1/2	1 1/32	.284	1.4	.6
18	40H18H	H	3.140	2.879	3	1 1/2	1 1/2	1 1/4	1/16	2 1/2	1 1/32	.284	1.4	.6
18	40P18H	P1	3.140	2.879	3	1 3/4	2 3/16	1 15/16	0	3	1 21/32	.284	2.7	1.4
19	40H19H	H	3.300	3.038	3	1 1/2	1 1/2	1 1/4	1/16	2 1/2	1 1/32	.284	1.6	.8
19	40P19H	P1	3.300	3.038	4	1 3/4	2 3/16	1 15/16	0	3	1 21/32	.284	2.6	1.3
20	40H20H	H	3.460	3.196	3	1 1/2	1 1/2	1 1/4	1/16	2 1/2	1 1/32	.284	1.7	.9
20	40P20H	P1	3.460	3.196	4	1 3/4	2 3/16	1 15/16	0	3	1 21/32	.284	2.6	1.3
21	40H21H	H	3.620	3.355	3	1 1/2	1 1/2	1 1/4	1/16	2 1/2	1 1/32	.284	1.7	.9
21	40P21H	P1	3.620	3.355	4	1 3/4	2 3/16	1 15/16	0	3	1 21/32	.284	2.8	1.5
22	40H22H	H	3.780	3.513	3	1 1/2	1 1/2	1 1/4	1/16	2 1/2	1 1/32	.284	1.8	1.0
22	40P22H	P1	3.780	3.513	4	1 3/4	2 3/16	1 15/16	0	3	1 21/32	.284	2.9	1.6
23	40H23H	H	3.940	3.672	3	1 1/2	1 1/2	1 1/4	1/16	2 1/2	1 1/32	.284	1.8	1.0
23	40P23H	P1	3.940	3.672	4	1 3/4	2 3/16	1 15/16	0	3	1 21/32	.284	3.0	1.7
24	40H24H	H	4.100	3.831	3	1 1/2	1 1/2	1 1/4	1/16	2 1/2	1 1/32	.284	1.9	1.1
24	40P24H	P1	4.100	3.831	4	1 3/4	2 3/16	1 15/16	0	3	1 21/32	.284	3.1	1.8
25	40H25H	H	4.260	3.989	3	1 1/2	1 1/2	1 1/4	1/16	2 1/2	1 1/32	.284	2.1	1.3
25	40P25H	P1	4.260	3.989	4	1 3/4	2 3/16	1 15/16	0	3	1 21/32	.284	3.2	1.9
26	40H26H	H	4.420	4.148	3	1 1/2	1 1/2	1 1/4	1/16	2 1/2	1 1/32	.284	2.1	1.3
26	40P26H	P1	4.420	4.148	4	1 3/4	2 3/16	1 15/16	0	3	1 21/32	.284	3.2	1.9
27	40H27H	H	4.580	4.307	3	1 1/2	1 1/2	1 1/4	1/16	2 1/2	1 1/32	.284	2.2	1.4
28	40H28H	H	4.740	4.466	3	1 1/2	1 1/2	1 1/4	1/16	2 1/2	1 1/32	.284	2.2	1.4
28	40P28H	P1	4.740	4.466	4	1 3/4	2 3/16	1 15/16	0	3	1 21/32	.284	3.4	2.1
29	40P29H	P1	4.900	4.625	4	1 3/4	2 3/16	1 15/16	0	3	1 21/32	.284	3.6	2.3
30	40H30H	H	5.060	4.783	3	1 1/2	1 1/2	1 1/4	1/16	2 1/2	1 1/32	.284	2.4	1.6
30	40P30H	P1	5.060	4.783	4	1 3/4	2 3/16	1 15/16	0	3	1 21/32	.284	3.6	2.3
31	40P31	P1	5.220	4.942	4	1 3/4	2 3/16	1 15/16	0	3	1 21/32	.284	3.8	2.5
32	40H32H	H	5.380	5.101	3	1 1/2	1 1/2	1 1/4	1/16	2 1/2	1 1/32	.284	2.6	1.8
32	40P32	P1	5.380	5.101	4	1 3/4	2 3/16	1 15/16	0	3	1 21/32	.284	3.9	2.6
33	40H33H	H	5.540	5.260	3	1 1/2	1 1/2	1 1/4	1/16	2 1/2	1 1/32	.284	2.7	1.9
33	40P33	P1	5.540	5.260	4	1 3/4	2 3/16	1 15/16	0	3	1 21/32	.284	3.9	2.6
34	40P34	P1	5.700	5.419	4	1 3/4	2 3/16	1 15/16	0	3	1 21/32	.284	4.1	2.8
35	40H35H	H	5.860	5.578	3	1 1/2	1 1/2	1 1/4	1/16	2 1/2	1 1/32	.284	2.9	2.1
35	40P35	P1	5.860	5.578	4	1 3/4	2 3/16	1 15/16	0	3	1 21/32	.284	4.2	2.9
36	40H36H	H	6.020	5.737	3	1 1/2	1 1/2	1 1/4	1/16	2 1/2	1 1/32	.284	3.1	2.3
36	40P36	P1	6.020	5.737	4	1 3/4	2 3/16	1 15/16	0	3	1 21/32	.284	4.4	3.1
37	40P37	P1	6.180	5.896	4	1 3/4	2 3/16	1 15/16	0	3	1 21/32	.284	4.6	3.3
38	40H38H	H	6.330	6.055	3	1 1/2	1 1/2	1 1/4	1/16	2 1/2	1 1/32	.284	3.4	2.6
38	40P38	P1	6.330	6.055	4	1 3/4	2 3/16	1 15/16	0	3	1 21/32	.284	4.6	3.3
40	40H40H	H	6.650	6.373	3	1 1/2	1 1/2	1 1/4	1/16	2 1/2	1 1/32	.284	3.6	2.8
40	40P40	P1	6.650	6.373	4	1 3/4	2 3/16	1 15/16	0	3	1 21/32	.284	4.8	3.5
41	40P41	P1	6.810	6.532	4	1 3/4	2 3/16	1 15/16	0	3	1 21/32	.284	4.9	3.6
42	40P42	P1	6.970	6.691	4	1 3/4	2 3/16	1 15/16	0	3	1 21/32	.284	5.2	3.9
44	40P44	P1	7.290	7.009	4	1 3/4	2 3/16	1 15/16	0	3	1 21/32	.284	5.3	4.0
45	40P45	P1	7.450	7.168	4	1 3/4	2 3/16	1 15/16	0	3	1 21/32	.284	5.5	4.2
47	40P47	P1	7.770	7.486	4	1 3/4	2 3/16	1 15/16	0	3	1 21/32	.284	5.9	4.6
48	40P48	P1	7.930	7.645	4	1 3/4	2 3/16	1 15/16	0	3	1 21/32	.284	6.1	4.8
50	40P50	P1	8.250	7.963	4	1 3/4	2 3/16	1 15/16	0	3	1 21/32	.284	6.3	5.0
54	40P54	P1	8.890	8.599	4	1 3/4	2 3/16	1 15/16	0	3	1 21/32	.284	6.8	5.5
56	40P56	P1	9.200	8.917	4	1 3/4	2 3/16	1 15/16	0	3	1 21/32	.284	7.2	5.9
60	40P60	P1	9.840	9.554	4	1 3/4	2 3/16	1 15/16	0	3	1 21/32	.284	7.9	6.6
60	40Q60	Q1	9.840	9.554	4	2 11/16	2 25/32	2 1/2	0	4 1/8	2 7/32	.284	12.3	8.8
70	40P70	P1	11.430	11.145	4	1 3/4	2 3/16	1 15/16	0	3	1 21/32	.284	9.9	8.6
70	40Q70	Q1	11.430	11.145	4	2 11/16	2 25/32	2 1/2	0	4 1/8	2 7/32	.284	14.5	11.0
72	40Q72	Q1	11.750	11.463	4	2 11/16	2 25/32	2 1/2	0	4 1/8	2 7/32	.284	14.7	11.2
80	40Q80	Q1	13.030	12.736	4	2 11/16	2 25/32	2 1/2	0	4 1/8	2 7/32	.284	16.6	13.1
84	40Q84	Q1	13.660	13.372	4	2 11/16	2 25/32	2 1/2	0	4 1/8	2 7/32	.284	17.6	14.1
96	40Q96	Q1	15.570	15.281	4	2 11/16	2 25/32	2 1/2	0	4 1/8	2 7/32	.284	16.3	12.8
112	40Q112	Q1	18.120	17.828	4	2 11/16	2 25/32	2 1/2	0	4 1/8	2 7/32	.284	20.8	17.3

Sprockets with "H" suffix have hardened teeth.

No. 40-2

1/2" Pitch

All Steel Stock Sprockets

Martin

Double-Type B

No. Teeth	Catalog Number	Outside Diameter	Type	Bore (inches)		Hub (inches)		Weight Lbs. (Approx.)
				Stock	Rec. Max.	Dia.	Length Thru	
11	D40B11H	2.000	B	1/2	3/4	1 1/16*	1 1/2	.62
12	D40B12H	2.170	B	1/2	5/8	1 1/16*	1 1/2	.76
13	D40B13H	2.330	B	1/2	1	1 1/2	1 1/2	.86
14	D40B14H	2.490	B	1/2	1 1/8	1 1/16	1 1/2	1.08
15	D40B15H	2.650	B	1/2	1 1/4	1 1/16	1 1/2	1.24
16	D40B16H	2.810	B	5/8	1 1/2	2	1 1/2	1.42
17	D40B17H	2.980	B	5/8	1 5/8	2 1/2	1 1/2	1.64
18	D40B18H	3.140	B	5/8	1 3/4	2 5/8	1 1/2	1.92
19	D40B19H	3.300	B	5/8	2	2 1/2	1 1/2	2.22
20	D40B20H	3.460	B	5/8	2 1/8	2 1/2	1 1/2	2.64
21	D40B21H	3.620	B	5/8	2 1/4	2 1/2	1 1/2	2.94
22	D40B22H	3.780	B	5/8	2 1/2	2 1/2	1 1/2	3.18
23	D40B23H	3.940	B	5/8	2	3	1 1/2	3.52
24	D40B24H	4.100	B	5/8	2 1/4	3 1/4	1 1/2	4.04
25	D40B25H	4.260	B	5/8	2 1/2	3 1/4	1 1/2	4.26
26	D40B26	4.420	B	5/8	2 1/2	3 1/4	1 1/2	4.48
30	D40B30	5.060	B	7/8	2 1/4	3 1/4	1 1/2	5.34
35	D40B35	5.860	B	7/8	2 1/2	3 1/4	1 1/2	6.80
36	D40B36	6.020	B	7/8	2 1/2	3 1/4	1 1/2	7.20
40	D40B40	6.650	B	1 1/16	2 1/2	3 1/4	1 1/2	9.40
42	D40B42	6.970	B	1 1/16	2 1/2	3 3/4	1 1/2	10.20
45	D40B45	7.450	B	1 1/16	2 1/2	3 3/4	1 1/2	11.36
48	D40B48	7.930	B	1 1/16	2 1/2	3 3/4	1 1/2	12.66
52	D40B52	8.570	B	1 1/16	2 1/2	3 3/4	1 1/2	14.46
54	D40B54	8.890	B	1 1/16	2 1/2	3 3/4	1 1/2	15.48
60	D40B60	9.840	B	1 1/16	2 1/2	3 3/4	1 1/2	18.60
68	D40B68	11.120	B	1 1/16	2 1/2	4 1/4	2 1/2	24.96
72	D40B72	11.750	B	1 1/16	2 1/2	4 1/4	2 1/2	27.88
76	D40B76	12.390	B	1 1/16	2 1/2	4 1/4	2 1/2	30.18
84	D40B84	13.660	B	1 1/16	2 1/2	4 1/4	2 1/2	36.24
95	D40B95	15.410	B	1 1/16	2 1/2	4 1/4	2 1/2	38.84
96	D40B96	15.570	B	1 1/16	2 1/2	4 1/4	2 1/2	39.50
102	D40B102	16.530	B	1 1/16	2 1/2	4 1/4	2 1/2	42.72
112	D40B112	18.120	B	1 1/16	2 1/2	4 1/4	2 1/2	55.54

* Has recessed groove in hub for chain clearance.

Maximum bores shown will accommodate standard keyseat and setscrew over keyseat. Slightly larger bores are possible with no keyseat, shallow keyseat, or setscrew at angle to keyseat.

NOTE: Double 40 stock sprockets with 25 teeth or less have hardened teeth. As indicated by H suffix.

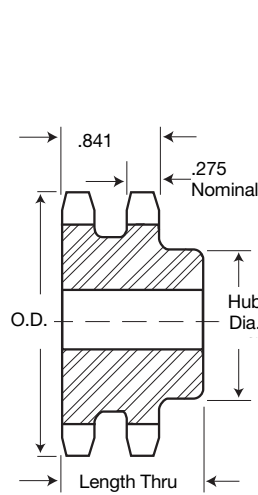

TYPE B

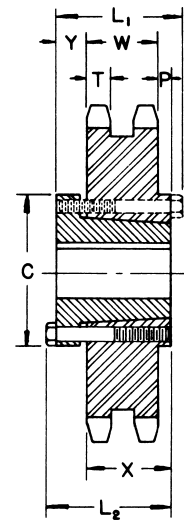

QD — TYPE C

Alteration Charges

See current discount sheet for alteration charges.

Double-Type QD

No. Teeth	Catalog Number	Bush-ing	Diameters		Type	Max. Bore	Dimensions								Weight (Approx.)	
			Outside Diameter	Pitch Diameter			L ₁	L ₂	C	Y	P	X	T	W	With Hub	Rim Only
36	D40SK36	SK	6.020	5.737	C	2%	2 1/2	2 1/2	3 3/8	5/8	1 1/2	1 1/4	.275	.841	6.68	4.68
40	D40SK40	SK	6.650	6.373	C										8.02	6.02
42	D40SK42	SK	6.970	6.691	C										8.82	6.82
45	D40SK45	SK	7.450	7.168	C										9.98	7.98
48	D40SK48	SK	7.930	7.645	C										11.22	9.22
52	D40SK52	SK	8.570	8.281	C										13.04	11.04
54	D40SK54	SK	8.890	8.599	C										14.06	12.06
60	D40SK60	SK	9.840	9.554	C	2%	2 1/2	2 1/2	3 3/8	5/8	1 1/2	1 1/4	.275	.841	16.98	14.98
68	D40SF68	SF	11.180	10.826	C	2 1/16	2 1/2	2 1/2	4 1/4	3/4	1 1/2	1 1/4	2.75	.841	22.72	19.72
72	D40SF72	SF	11.750	11.463	C										24.20	22.20
76	D40SF76	SF	12.390	12.099	C										28.20	25.20
84	D40SF84	SF	13.660	13.372	C										33.64	30.64
95	D40SF95	SF	15.410	15.122	C										40.22	37.22
102	D40SF102	SF	16.530	16.236	C										42.70	39.70
112	D40SF112	SF	18.120	17.828	C	2 1/16	2 1/2	2 1/2	4 1/4	3/4	1 1/2	1 1/4	2.75	.841	52.60	49.60

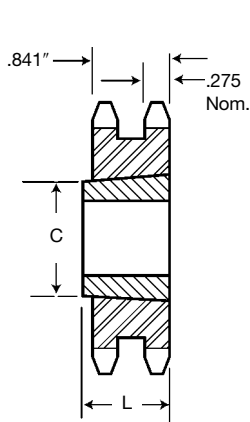
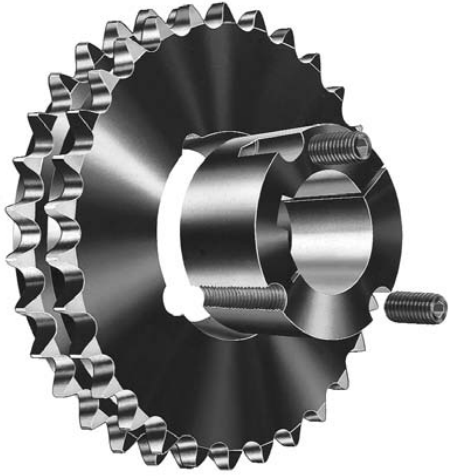

TYPE A

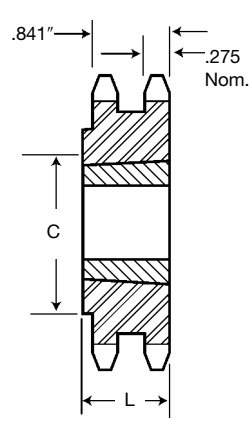

TYPE B

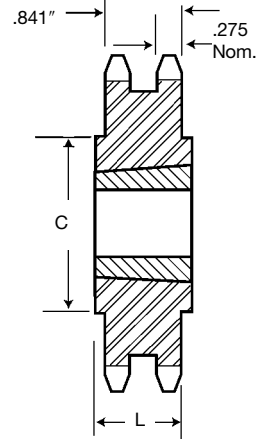

TYPE C

Double-Taper Bushed

No. Teeth	Catalog Number	Bushing	Diameters		Max. Bore	Dimensions		Type	Weight (Approx.)	
			Outside Diameter	Pitch Diameter		L	C		Rim Only	Bushing Only
15	D40ATB15H	1008	2.652	2.405	1	3/8	1 1/4	A	.5	.3
16	D40ATB16H	1008	2.814	2.563	1	3/8	1 1/4	A	.6	.3
17	D40ATB17H	1008	2.975	2.721	1	3/8	1 1/4	A	.7	.3
18	D40BTB18H	1210	3.135	2.879	1 1/4	1	2 5/8	B	.7	.6
19	D40BTB19H	1210	3.296	3.038	1 1/4	1	2 1/2	B	.9	.6
20	D40BTB20H	1610	3.457	3.196	1 1/4	1	2 5/8	B	.9	.9
21	D40BTB21H	1610	3.617	3.355	1 1/4	1	2 5/8	B	1.0	.9
23	D40BTB23H	1610	3.938	3.672	1 1/4	1	3	B	1.3	.9
25	D40BTB25H	2012	4.258	3.989	2	1 1/4	3 13/32	B	1.6	1.7
30	D40BTB30	2012	5.057	4.783	2	1 1/4	4 5/64	B	3.4	1.7
36	D40BTB36	2012	6.015	5.737	2	1 1/4	5 5/32	B	5.9	1.7
42	D40CTB42	2517	6.972	6.691	2 1/2	1 3/4	4 1/4	C	7.0	3.5
48	D40CTB48	2517	7.928	7.645	2 1/2	1 3/4	4 1/4	C	9.6	3.5
52	D40CTB52	2517	8.566	8.281	2 1/2	1 3/4	4 1/4	C	11.4	3.5
60	D40CTB60	2517	9.841	9.554	2 1/2	1 3/4	4 1/4	C	15.4	3.5
68	D40CTB68	2517	11.115	10.826	2 1/2	1 3/4	4 1/4	C	20.5	3.5
76	D40CTB76	2517	12.389	12.099	2 1/2	1 3/4	4 1/4	C	25.7	3.5
84	D40CTB84	2517	13.663	13.372	2 1/2	1 3/4	4 1/4	C	31.6	3.5
95	D40CTB95	2517	15.414	15.122	2 1/2	1 3/4	4 1/4	C	34.1	3.5
102	D40CTB102	2517	16.529	16.236	2 1/2	1 3/4	4 1/4	C	36.8	3.5

NOTE: Double 40 stock sprockets with 25 teeth or less have hardened teeth.
As indicated by H suffix.

No. 40-2

1/2" Pitch

MST® Sprockets

Martin

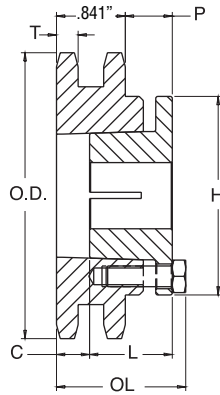

TYPE 11

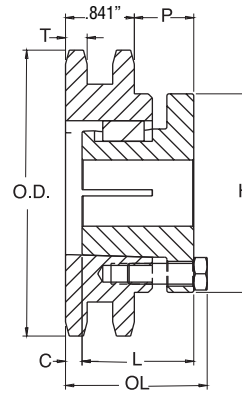

TYPE 12

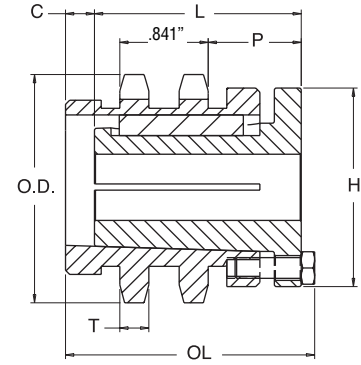

TYPE 16

Double - MST® Sprockets

No. Teeth	Catalog Number	Bush-ing	Diameters		Type	Max. Bore	Dimensions						Weight (Approx.)	
			Outside Dia.	Pitch Dia.			OL	L	C	H	P	T(nom)	With Hub	Rim Only
15	D40H15H	H	2.650	2.405	11	1-1/2	2-5/32	1-1/4	23/32	2-1/2	1-1/8	.275	1.7	.9
16	D40H16H	H	2.810	2.563	11	1-1/2	2-5/32	1-1/4	23/32	2-1/2	1-1/8	.275	1.8	1.0
17	D40H17H	H	2.980	2.721	11	1-1/2	2-5/32	1-1/4	23/32	2-1/2	1-1/8	.275	1.9	1.1
18	D40P18H	P1	3.140	2.879	16	1-3/4	3 3/16	1-15/16	1	3	1-3/8	.275	3.1	1.8
19	D40P19H	P1	3.300	3.038	12	1-3/4	2 15/32	1-15/16	9/32	3	1-3/8	.275	2.7	1.4
20	D40P20H	P1	3.460	3.196	12	1-3/4	2-13/32	1-15/16	7/32	3	1-3/8	.275	2.9	1.6
21	D40P21H	P1	3.620	3.355	12	1-3/4	2-13/32	1-15/16	7/32	3	1-3/8	.275	3.1	1.8
22	D40P22H	P1	3.780	3.513	12	1-3/4	2-13/32	1-15/16	7/32	3	1-3/8	.275	3.3	2.0
23	D40P23H	P1	3.940	3.672	12	1-3/4	2-3/16	1-15/16	0	3	1-3/32	.275	3.3	2.0
24	D40P24H	P1	4.100	3.831	12	1-3/4	2-3/16	1-15/16	0	3	1-3/32	.275	3.5	2.2
25	D40P25H	P1	4.260	3.989	12	1-3/4	2-3/16	1-15/16	0	3	1-3/32	.275	3.8	2.5
26	D40P26H	P1	4.420	4.148	12	1-3/4	2-3/16	1-15/16	0	3	1-3/32	.275	4.0	2.7
28	D40P28H	P1	4.740	4.466	12	1-3/4	2-3/16	1-15/16	0	3	1-3/32	.275	4.4	3.1
30	D40Q30H	Q1	5.060	4.783	12	2-11/16	2-25/32	2-1/2	0	4-1/8	1-21/32	.275	7.7	4.2
32	D40Q32H	Q1	5.380	5.101	12	2-11/16	2-25/32	2-1/2	0	4-1/8	1-21/32	.275	8.8	5.3
35	D40Q35H	Q1	5.860	5.578	12	2-11/16	2-25/32	2-1/2	0	4-1/8	1-21/32	.275	9.6	6.1
36	D40Q36H	Q1	6.020	5.737	12	2-11/16	2-25/32	2-1/2	0	4-1/8	1-21/32	.275	10.0	6.5
40	D40Q40H	Q1	6.650	6.373	12	2-11/16	2-25/32	2-1/2	0	4-1/8	1-21/32	.275	11.4	7.9
42	D40Q42H	Q1	6.970	6.691	12	2-11/16	2-25/32	2-1/2	0	4-1/8	1-21/32	.275	12.4	8.9
45	D40Q45H	Q1	7.450	7.168	12	2-11/16	2-25/32	2-1/2	0	4-1/8	1-21/32	.275	13.6	10.1
48	D40Q48H	Q1	7.930	7.645	12	2-11/16	2-25/32	2-1/2	0	4-1/8	1-21/32	.275	15.3	11.8
52	D40Q52H	Q1	8.570	8.281	12	2-11/16	2-25/32	2-1/2	0	4-1/8	1-21/32	.275	16.1	12.6
54	D40Q54H	Q1	8.890	8.599	12	2-11/16	2-25/32	2-1/2	0	4-1/8	1-21/32	.275	17.8	14.3
60	D40Q60H	Q1	9.840	9.554	12	2-11/16	2-25/32	2-1/2	0	4-1/8	1-21/32	.275	20.9	17.4
68	D40Q68	Q1	11.120	10.826	12	2-11/16	2-25/32	2-1/2	0	4-1/8	1-21/32	.275	25.0	21.5
72	D40Q72	Q1	11.750	11.463	12	2-11/16	2-25/32	2-1/2	0	4-1/8	1-21/32	.275	28.5	25.0
76	D40Q76	Q1	12.390	12.099	12	2-11/16	2-25/32	2-1/2	0	4-1/8	1-21/32	.275	30.4	26.9
84	D40Q84	Q1	13.660	13.372	12	2-11/16	2-25/32	2-1/2	0	4-1/8	1-21/32	.275	37.6	34.1
95	D40Q95	Q1	15.410	15.122	12	2-11/16	2-25/32	2-1/2	0	4-1/8	1-21/32	.275	45.5	42.0
96	D40Q96	Q1	15.570	15.281	12	2-11/16	2-25/32	2-1/2	0	4-1/8	1-21/32	.275	47.6	44.1
102	D40Q102	Q1	16.530	16.236	12	2-11/16	2-25/32	2-1/2	0	4-1/8	1-21/32	.275	52.0	48.5
112	D40Q112	Q1	18.120	17.828	12	2-11/16	2-25/32	2-1/2	0	4-1/8	1-21/32	.275	64.5	61.0

Sprockets with "H" suffix have hardened teeth.

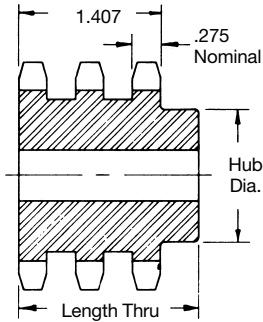

TYPE B

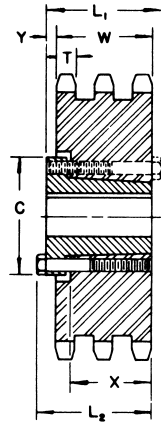

QD — TYPE B

Alteration Charges

See current discount sheet for alteration charges.

Triple-Type B

No. Teeth	Catalog Number	Outside Diameter	Type	Bore (inches)		Hub (inches)		Weight Lbs. (Approx.)
				Stock	Rec. Max.	Dia.	Length Thru	
11	E40B11H	2.000	B	1/2	3/4	1 1/16*	2 1/2	.80
12	E40B12H	2.170	B	1/2	13/16	1 1/16*	2 1/2	1.10
13	E40B13H	2.330	B	1/2	1	1 1/2	2 1/2	1.24
14	E40B14H	2.490	B	1/2	1 1/16	1 1/16	2 1/2	1.50
15	E40B15H	2.650	B	1/2	1 1/4	2 1/16	2 1/2	1.76
16	E40B16H	2.810	B	5/8	1 1/2	2	2 1/2	2.04
17	E40B17H	2.980	B	5/8	1 5/8	2 1/2	2 1/2	2.34
18	E40B18H	3.140	B	5/8	1 3/4	2 5/8	2 1/2	2.72
19	E40B19H	3.300	B	5/8	1 7/8	2 1/2	2 1/2	3.10
20	E40B20H	3.460	B	5/8	1 7/8	2 1/2	2 1/2	3.72
21	E40B21H	3.620	B	5/8	1 7/8	2 1/2	2 1/2	4.06
22	E40B22H	3.780	B	5/8	1 7/8	2 1/2	2 1/2	4.52
23	E40B23H	3.940	B	5/8	2	3	2 1/2	4.96
24	E40B24H	4.100	B	5/8	2 1/4	3 1/4	2 1/2	5.64
25	E40B25H	4.260	B	5/8	2 1/4	3 1/4	2 1/2	6.02
26	E40B26	4.420	B	5/8	2 1/4	3 1/4	2 1/2	6.36
30	E40B30	5.060	B	7/8	2 1/2	3 1/4	2 1/2	7.84
35	E40B35	5.860	B	7/8	2 1/2	3 1/4	2 1/2	10.30
36	E40B36	6.020	B	7/8	2 1/2	3 1/4	2 1/2	11.72
42	E40B42	6.970	B	1 1/16	2 1/2	3 1/4	2 1/2	15.36
48	E40B48	7.930	B	1 1/16	2 1/2	3 1/4	2 1/2	19.36
52	E40B52	8.570	B	1 1/16	2 1/2	3 1/4	2 1/2	22.44
60	E40B60	9.840	B	1 1/16	2 1/2	3 1/4	2 1/2	30.02
68	E40B68	11.120	B	1 1/16	2 1/2	4	2 1/2	38.44
72	E40B72	11.750	B	1 1/16	2 1/2	4	2 1/2	42.46
76	E40B76	12.390	B	1 1/16	2 1/2	4	2 1/2	46.90
84	E40B84	13.660	B	1 1/16	2 1/2	4 1/4	2 1/2	57.30
95	E40B95	15.410	B	1 1/16	2 1/2	4 1/4	2 1/2	62.18
102	E40B102	16.530	B	1 1/16	2 1/2	4 1/4	2 1/2	68.40

* Has recessed groove in hub for chain clearance.

Maximum bores shown will accommodate standard keyseat and setscrew over keyseat. Slightly larger bores are possible with no keyseat, shallow keyseat, or setscrew at angle to keyseat.

NOTE: Triple 40 stock sprockets with 25 teeth or less have hardened teeth. As indicated by H suffix.

SPROCKETS

Triple-Type QD

No. Teeth	Catalog Number	Bushing	Diameters		Type	Max. Bore	Dimensions							Weight (Approx.)	
			Outside Diameter	Pitch Diameter			L ₁	L ₂	C	Y	X	T	W	With Hub	Rim Only
36	E40SK36	SK	6.020	5.737	B	2%	2 1/2	2 1/2	3%	1 1/2	1 1/4	.275	1.407	8.16	6.16
42	E40SK42	SK	6.970	6.691	B									11.92	9.52
48	E40SK48	SK	7.930	7.645	B									15.13	13.16
52	E40SK52	SK	8.570	8.281	B									18.08	16.08
60	E40SK60	SK	9.840	9.554	B	2%	2 1/2	2 1/2	3%	1 1/2	1 1/4	.275	1.407	24.60	22.60
68	E40SF68	SF	11.120	10.826	B	2 1/16	2 1/4	2 1/4	4%	1 1/2	1 1/4	.275	1.407	31.98	29.98
72	E40SF72	SF	11.750	11.463	B									37.40	34.40
76	E40SF76	SF	12.390	12.099	B									51.92	48.92
84	E40SF84	SF	13.660	13.372	B									56.70	53.78
95	E40SF95	SF	15.410	15.122	B									58.94	55.94
102	E40SF102	SF	16.530	16.236	B	2 1/16	2 1/4	2 1/4	4%	1 1/2	1 1/4	.275	1.407	62.24	59.24

No. 40-3

1/2" Pitch

MST[®] Sprockets

Martin

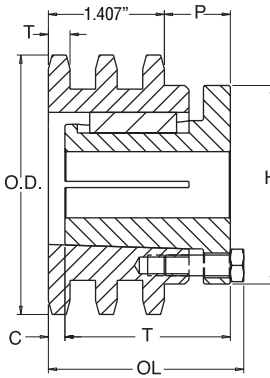
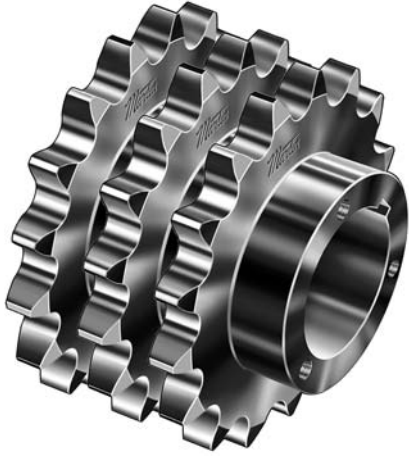

TYPE 22

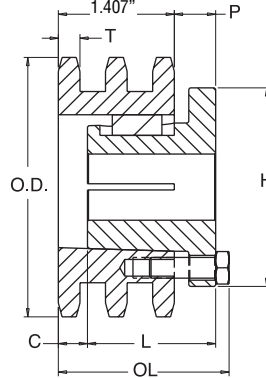

TYPE 23

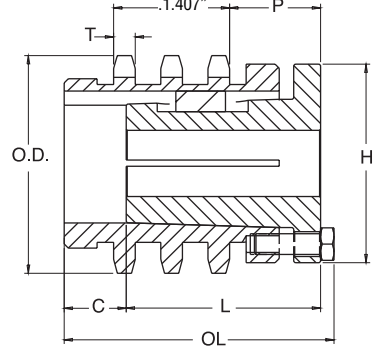

TYPE 27

SPROCKETS

Triple - MST[®] Sprockets

No. Teeth	Catalog Number	Bush-ing	Diameters		Type	Max. Bore	Dimensions					Weight (Approx.)		
			Outside Dia.	Pitch Dia.			OL	L	C	H	P	T(nom)	With Hub	Rim Only
18	E40P18H	P1	3.140	2.879	27	1-3/4	3-3/4	1-15/16	1 9/16	3	1-3/8	.275	3.2	1.9
19	E40P19H	P1	3.300	3.038	22	1-3/4	3 1/32	1-15/16	27/32	3	1-3/8	.275	3.1	1.8
20	E40P20H	P1	3.460	3.196	22	1-3/4	2 31/32	1-15/16	25/32	3	1-5/16	.275	3.3	2.0
23	E40P23H	P1	3.940	3.672	23	1-3/4	2-9/32	1-15/16	3/32	3	5/8	.275	3.6	2.3
24	E40P24H	P1	4.100	3.831	23	1-3/4	2-9/32	1-15/16	3/32	3	5/8	.275	3.9	2.6
25	E40P25H	P1	4.260	3.989	23	1-3/4	2-9/32	1-15/16	3/32	3	5/8	.275	4.3	3.0
27	E40P27H	P1	4.580	4.307	23	1-3/4	2-9/32	1-15/16	3/32	3	5/8	.275	4.6	3.3
30	E40Q30H	Q1	5.060	4.783	22	2-11/16	2-25/32	2-1/2	0	4-1/8	1-3/32	.275	8.0	4.5
35	E40Q35H	Q1	5.860	5.578	22	2-11/16	2-25/32	2-1/2	0	4-1/8	1-3/32	.275	10.4	6.9
36	E40Q36H	Q1	6.020	5.737	22	2-11/16	2-25/32	2-1/2	0	4-1/8	1-3/32	.275	11.1	7.6
42	E40Q42H	Q1	6.970	6.691	22	2-11/16	2-25/32	2-1/2	0	4-1/8	1-3/32	.275	14.6	11.1
48	E40Q48H	Q1	7.930	7.645	22	2-11/16	2-25/32	2-1/2	0	4-1/8	1-3/32	.275	18.7	15.2
52	E40Q52H	Q1	8.570	8.281	22	2-11/16	2-25/32	2-1/2	0	4-1/8	1-3/32	.275	22.2	18.7
54	E40Q54H	Q1	8.890	8.599	22	2-11/16	2-25/32	2-1/2	0	4-1/8	1-3/32	.275	23.4	19.9
60	E40Q60H	Q1	9.840	9.554	22	2-11/16	2-25/32	2-1/2	0	4-1/8	1-3/32	.275	28.8	25.3
68	E40Q68H	Q1	11.120	10.826	22	2-11/16	2-25/32	2-1/2	0	4-1/8	1-3/32	.275	37.0	33.5
72	E40Q72H	Q1	11.750	11.463	22	2-11/16	2-25/32	2-1/2	0	4-1/8	1-3/32	.275	41.4	37.9
76	E40Q76H	Q1	12.390	12.099	22	2-11/16	2-25/32	2-1/2	0	4-1/8	1-3/32	.275	46.0	42.5
84	E40Q84H	Q1	13.660	13.372	22	2-11/16	2-25/32	2-1/2	0	4-1/8	1-3/32	.275	55.9	52.4
95	E40Q95H	Q1	15.410	15.122	22	2-11/16	2-25/32	2-1/2	0	4-1/8	1-3/32	.275	71.4	67.9
102	E40Q102H	Q1	16.530	16.236	22	2-11/16	2-25/32	2-1/2	0	4-1/8	1-3/32	.275	82.0	78.5

Sprockets with "H" suffix have hardened teeth.



All Steel Stock Sprockets

No. 50 5/8" Pitch

Single Type "BS" — 2 Setscrews — Bored-To-Size

No. Teeth	Catalog Number	Outside Diameter	Length Thru Bore	Weight Lbs. (Approx.)	Stock Finished Bores Includes Keyway and 2 Setscrews
9	50BS9	2.090	1	.30	5/8 - 3/4
10	50BS10	2.300	1	.30	5/8 - 3/4 - 7/8 - 1*
11	50BS11	2.500	1	.60	5/8 - 3/4 - 7/8 - 1
12	50BS12	2.710	1	.70	5/8 - 3/4 - 7/8 - 1 - 1 1/8 - 1 1/2 - 1 5/8 - 1 3/4
13	50BS13	2.910	1	.80	5/8 - 3/4 - 7/8 - 1 - 1 1/8 - 1 1/2 - 1 5/8 - 1 3/4
14	50BS14	3.110	1	1.00	5/8 - 3/4 - 7/8 - 1 - 1 1/8 - 1 1/2 - 1 5/8 - 1 3/4
15	50BS15	3.320	1	1.20	5/8 - 3/4 - 7/8 - 1 - 1 1/8 - 1 1/2 - 1 5/8 - 1 3/4 - 1 7/8 - 1 5/4 - 1 1/2
16	50BS16	3.520	1	1.45	5/8 - 3/4 - 7/8 - 1 - 1 1/8 - 1 1/2 - 1 5/8 - 1 3/4 - 1 7/8 - 1 5/4 - 1 1/2 - 1 3/4
17	50BS17	3.720	1	1.60	5/8 - 3/4 - 7/8 - 1 - 1 1/8 - 1 1/2 - 1 5/8 - 1 3/4 - 1 7/8 - 1 5/4 - 1 1/2 - 1 3/4
18	50BS18	3.920	1	1.90	5/8 - 3/4 - 7/8 - 1 - 1 1/8 - 1 1/2 - 1 5/8 - 1 3/4 - 1 7/8 - 1 5/4 - 1 1/2 - 1 3/4
19	50BS19	4.120	1	2.00	5/8 - 3/4 - 7/8 - 1 - 1 1/8 - 1 1/2 - 1 5/8 - 1 3/4 - 1 7/8 - 1 5/4 - 1 1/2 - 1 3/4
20	50BS20	4.320	1	2.10	5/8 - 3/4 - 7/8 - 1 - 1 1/8 - 1 1/2 - 1 5/8 - 1 3/4 - 1 7/8 - 1 5/4 - 1 1/2 - 1 3/4
21	50BS21	4.520	1	2.25	5/8 - 3/4 - 7/8 - 1 - 1 1/8 - 1 1/2 - 1 5/8 - 1 3/4 - 1 7/8 - 1 5/4 - 1 1/2 - 1 3/4
22	50BS22	4.720	1	2.40	5/8 - 3/4 - 7/8 - 1 - 1 1/8 - 1 1/2 - 1 5/8 - 1 3/4 - 1 7/8 - 1 5/4 - 1 1/2 - 1 3/4
23	50BS23	4.920	1	2.50	5/8 - 3/4 - 7/8 - 1 - 1 1/8 - 1 1/2 - 1 5/8 - 1 3/4 - 1 7/8 - 1 5/4 - 1 1/2 - 1 3/4
24	50BS24	5.120	1 1/4	3.00	5/8 - 3/4 - 7/8 - 1 - 1 1/8 - 1 1/2 - 1 5/8 - 1 3/4 - 1 7/8 - 1 5/4 - 1 1/2 - 1 3/4
25	50BS25	5.320	1 1/4	3.10	5/8 - 3/4 - 7/8 - 1 - 1 1/8 - 1 1/2 - 1 5/8 - 1 3/4 - 1 7/8 - 1 5/4 - 1 1/2 - 1 3/4
26	50BS26	5.520	1 1/4	3.30	5/8 - 3/4 - 7/8 - 1 - 1 1/8 - 1 1/2 - 1 5/8 - 1 3/4 - 1 7/8 - 1 5/4 - 1 1/2 - 1 3/4
27	50BS27	5.720	1 1/4	3.46	5/8 - 3/4 - 7/8 - 1 - 1 1/8 - 1 1/2 - 1 5/8 - 1 3/4 - 1 7/8 - 1 5/4 - 1 1/2 - 1 3/4
28	50BS28	5.920	1 1/4	3.60	5/8 - 3/4 - 7/8 - 1 - 1 1/8 - 1 1/2 - 1 5/8 - 1 3/4 - 1 7/8 - 1 5/4 - 1 1/2 - 1 3/4
29	50BS29	6.120	1 1/4	3.78	5/8 - 3/4 - 7/8 - 1 - 1 1/8 - 1 1/2 - 1 5/8 - 1 3/4 - 1 7/8 - 1 5/4 - 1 1/2 - 1 3/4
30	50BS30	6.320	1 1/4	3.90	5/8 - 3/4 - 7/8 - 1 - 1 1/8 - 1 1/2 - 1 5/8 - 1 3/4 - 1 7/8 - 1 5/4 - 1 1/2 - 1 3/4
31	50BS31	6.520	1 1/4	4.46	5/8 - 3/4 - 7/8 - 1 - 1 1/8 - 1 1/2 - 1 5/8 - 1 3/4 - 1 7/8 - 1 5/4 - 1 1/2 - 1 3/4 - 1 1 1/8 - 1 1 1/4
32	50BS32	6.720	1 1/4	4.70	5/8 - 3/4 - 7/8 - 1 - 1 1/8 - 1 1/2 - 1 5/8 - 1 3/4 - 1 7/8 - 1 5/4 - 1 1/2 - 1 3/4 - 1 1 1/8 - 1 1 1/4
33	50BS33	6.920	1 1/4	4.92	5/8 - 3/4 - 7/8 - 1 - 1 1/8 - 1 1/2 - 1 5/8 - 1 3/4 - 1 7/8 - 1 5/4 - 1 1/2 - 1 3/4 - 1 1 1/8 - 1 1 1/4
34	50BS34	7.120	1 1/4	5.06	5/8 - 3/4 - 7/8 - 1 - 1 1/8 - 1 1/2 - 1 5/8 - 1 3/4 - 1 7/8 - 1 5/4 - 1 1/2 - 1 3/4 - 1 1 1/8 - 1 1 1/4
35	50BS35	7.320	1 1/4	5.30	5/8 - 3/4 - 7/8 - 1 - 1 1/8 - 1 1/2 - 1 5/8 - 1 3/4 - 1 7/8 - 1 5/4 - 1 1/2 - 1 3/4 - 1 1 1/8 - 1 1 1/4
36	50BS36	7.520	1 1/4	5.50	5/8 - 3/4 - 7/8 - 1 - 1 1/8 - 1 1/2 - 1 5/8 - 1 3/4 - 1 7/8 - 1 5/4 - 1 1/2 - 1 3/4 - 1 1 1/8 - 1 1 1/4
37	50BS37	7.720	1 1/4	5.62	5/8 - 3/4 - 7/8 - 1 - 1 1/8 - 1 1/2 - 1 5/8 - 1 3/4 - 1 7/8 - 1 5/4 - 1 1/2 - 1 3/4 - 1 1 1/8 - 1 1 1/4
38	50BS38	7.920	1 1/4	5.80	5/8 - 3/4 - 7/8 - 1 - 1 1/8 - 1 1/2 - 1 5/8 - 1 3/4 - 1 7/8 - 1 5/4 - 1 1/2 - 1 3/4 - 1 1 1/8 - 1 1 1/4
39	50BS39	8.120	1 1/4	6.02	5/8 - 3/4 - 7/8 - 1 - 1 1/8 - 1 1/2 - 1 5/8 - 1 3/4 - 1 7/8 - 1 5/4 - 1 1/2 - 1 3/4 - 1 1 1/8 - 1 1 1/4
40	50BS40	8.320	1 1/4	6.20	5/8 - 3/4 - 7/8 - 1 - 1 1/8 - 1 1/2 - 1 5/8 - 1 3/4 - 1 7/8 - 1 5/4 - 1 1/2 - 1 3/4 - 1 1 1/8 - 1 1 1/4
41	50BS41	8.520	1 1/4	6.45	5/8 - 3/4 - 7/8 - 1 - 1 1/8 - 1 1/2 - 1 5/8 - 1 3/4 - 1 7/8 - 1 5/4 - 1 1/2 - 1 3/4 - 1 1 1/8 - 1 1 1/4
42	50BS42	8.720	1 1/4	6.68	5/8 - 3/4 - 7/8 - 1 - 1 1/8 - 1 1/2 - 1 5/8 - 1 3/4 - 1 7/8 - 1 5/4 - 1 1/2 - 1 3/4 - 1 1 1/8 - 1 1 1/4
43	50BS43	8.910	1 1/4	6.99	5/8 - 3/4 - 7/8 - 1 - 1 1/8 - 1 1/2 - 1 5/8 - 1 3/4 - 1 7/8 - 1 5/4 - 1 1/2 - 1 3/4 - 1 1 1/8 - 1 1 1/4
44	50BS44	9.110	1 1/4	7.30	5/8 - 3/4 - 7/8 - 1 - 1 1/8 - 1 1/2 - 1 5/8 - 1 3/4 - 1 7/8 - 1 5/4 - 1 1/2 - 1 3/4 - 1 1 1/8 - 1 1 1/4
45	50BS45	9.310	1 1/4	8.00	5/8 - 3/4 - 7/8 - 1 - 1 1/8 - 1 1/2 - 1 5/8 - 1 3/4 - 1 7/8 - 1 5/4 - 1 1/2 - 1 3/4 - 1 1 1/8 - 1 1 1/4
46	50BS46	9.510	1 1/4	8.51	1 - 1 1/8 - 1 1/2 - 1 5/8 - 1 3/4 - 1 7/8 - 1 5/4 - 1 1/2 - 1 3/4 - 1 1 1/8 - 1 1 1/4
47	50BS47	9.710	1 1/4	8.76	1 - 1 1/8 - 1 1/2 - 1 5/8 - 1 3/4 - 1 7/8 - 1 5/4 - 1 1/2 - 1 3/4 - 1 1 1/8 - 1 1 1/4
48	50BS48	9.910	1 1/4	9.03	1 - 1 1/8 - 1 1/2 - 1 5/8 - 1 3/4 - 1 7/8 - 1 5/4 - 1 1/2 - 1 3/4 - 1 1 1/8 - 1 1 1/4
49	50BS49	10.110	1 1/4	9.33	1 - 1 1/8 - 1 1/2 - 1 5/8 - 1 3/4 - 1 7/8 - 1 5/4 - 1 1/2 - 1 3/4 - 1 1 1/8 - 1 1 1/4
50	50BS50	10.310	1 1/4	9.63	1 - 1 1/8 - 1 1/2 - 1 5/8 - 1 3/4 - 1 7/8 - 1 5/4 - 1 1/2 - 1 3/4 - 1 1 1/8 - 1 1 1/4
51	50BS51	10.510	1 1/4	9.81	1 - 1 1/8 - 1 1/2 - 1 5/8 - 1 3/4 - 1 7/8 - 1 5/4 - 1 1/2 - 1 3/4 - 1 1 1/8 - 1 1 1/4
52	50BS52	10.710	1 1/4	9.99	1 - 1 1/8 - 1 1/2 - 1 5/8 - 1 3/4 - 1 7/8 - 1 5/4 - 1 1/2 - 1 3/4 - 1 1 1/8 - 1 1 1/4
53	50BS53	10.910	1 1/4	10.37	1 - 1 1/8 - 1 1/2 - 1 5/8 - 1 3/4 - 1 7/8 - 1 5/4 - 1 1/2 - 1 3/4 - 1 1 1/8 - 1 1 1/4
54	50BS54	11.110	1 1/4	10.75	1 - 1 1/8 - 1 1/2 - 1 5/8 - 1 3/4 - 1 7/8 - 1 5/4 - 1 1/2 - 1 3/4 - 1 1 1/8 - 1 1 1/4
55	50BS55	11.310	1 1/4	11.08	1 - 1 1/8 - 1 1/2 - 1 5/8 - 1 3/4 - 1 7/8 - 1 5/4 - 1 1/2 - 1 3/4 - 1 1 1/8 - 1 1 1/4
56	50BS56	11.500	1 1/4	11.41	1 - 1 1/8 - 1 1/2 - 1 5/8 - 1 3/4 - 1 7/8 - 1 5/4 - 1 1/2 - 1 3/4 - 1 1 1/8 - 1 1 1/4
57	50BS57	11.700	1 1/4	11.75	1 - 1 1/8 - 1 1/2 - 1 5/8 - 1 3/4 - 1 7/8 - 1 5/4 - 1 1/2 - 1 3/4 - 1 1 1/8 - 1 1 1/4
58	50BS58	11.900	1 1/4	12.08	1 - 1 1/8 - 1 1/2 - 1 5/8 - 1 3/4 - 1 7/8 - 1 5/4 - 1 1/2 - 1 3/4 - 1 1 1/8 - 1 1 1/4
59	50BS59	12.100	1 1/4	12.41	1 - 1 1/8 - 1 1/2 - 1 5/8 - 1 3/4 - 1 7/8 - 1 5/4 - 1 1/2 - 1 3/4 - 1 1 1/8 - 1 1 1/4
60	50BS60	12.300	1 1/4	13.50	1 - 1 1/8 - 1 1/2 - 1 5/8 - 1 3/4 - 1 7/8 - 1 5/4 - 1 1/2 - 1 3/4 - 1 1 1/8 - 1 1 1/4
70	50BS70	14.290	1 1/4	17.81	1 - 1 1/8 - 1 1/2 - 1 5/8 - 1 3/4 - 1 7/8 - 1 5/4 - 1 1/2 - 1 3/4 - 1 1 1/8 - 1 1 1/4
72	50BS72	14.690	1 1/4	19.13	1 - 1 1/8 - 1 1/2 - 1 5/8 - 1 3/4 - 1 7/8 - 1 5/4 - 1 1/2 - 1 3/4 - 1 1 1/8 - 1 1 1/4
80	50BS80	16.280	1 1/4	24.39	1 - 1 1/8 - 1 1/2 - 1 5/8 - 1 3/4 - 1 7/8 - 1 5/4 - 1 1/2 - 1 3/4 - 1 1 1/8 - 1 1 1/4
84	50BS84	17.080	1 1/4	25.15	1 - 1 1/8 - 1 1/2 - 1 5/8 - 1 3/4 - 1 7/8 - 1 5/4 - 1 1/2 - 1 3/4 - 1 1 1/8 - 1 1 1/4
96	50BS96	19.470	1 1/4	32.57	1 - 1 1/8 - 1 1/2 - 1 5/8 - 1 3/4 - 1 7/8 - 1 5/4 - 1 1/2 - 1 3/4 - 1 1 1/8 - 1 1 1/4
112	50BS112	22.650	1 1/4	41.65	1 - 1 1/8 - 1 1/2 - 1 5/8 - 1 3/4 - 1 7/8 - 1 5/4 - 1 1/2 - 1 3/4 - 1 1 1/8 - 1 1 1/4

* Keyway with Setscrew at 90°.

Hub diameters vary to suit different bore sizes.

KEYWAY IS ON CENTER LINE OF TOOTH.

SPROCKETS

No. 50
5/8" Pitch

All Steel
Stock Sprockets

Martin



No. 50 — Hardened Teeth — 2 Setscrews — Bored-To-Size

No. Teeth	Catalog Number	Outside Diameter	Length Thru Bore	Weight Lbs. (Approx.)	Stock Finished Bores Includes Keyway and 2 Setscrews
9	50BS9HT	2.09	1	.3	$\frac{5}{8} - \frac{3}{4}$
10	50BS10HT	2.30	1	.3	$\frac{5}{8} - \frac{3}{4} - \frac{7}{8} - \dagger 1$
11	50BS11HT	2.50	1	.6	$\frac{5}{8} - \frac{3}{4} - \frac{7}{8} - 1$
12	50BS12HT	2.71	1	.7	$\frac{5}{8} - \frac{3}{4} - \frac{7}{8} - 1 - 1\frac{1}{2} - 1\frac{5}{8} - 1\frac{1}{4}$
13	50BS13HT	2.91	1	.8	$\frac{5}{8} - \frac{3}{4} - \frac{7}{8} - 1 - 1\frac{1}{2} - 1\frac{5}{8} - 1\frac{1}{4}$
14	50BS14HT	3.11	1	1.0	$\frac{5}{8} - \frac{3}{4} - \frac{7}{8} - 1 - 1\frac{1}{2} - 1\frac{5}{8} - 1\frac{1}{4}$
15	50BS15HT	3.32	1	1.2	$\frac{5}{8} - \frac{3}{4} - \frac{7}{8} - 1 - 1\frac{1}{2} - 1\frac{5}{8} - 1\frac{1}{4} - 1\frac{1}{2} - 1\frac{5}{8} - 1\frac{1}{2}$
16	50BS16HT	3.52	1	1.5	$\frac{5}{8} - \frac{3}{4} - \frac{7}{8} - 1 - 1\frac{1}{2} - 1\frac{5}{8} - 1\frac{1}{4} - 1\frac{1}{2} - 1\frac{5}{8} - 1\frac{1}{2} - 1\frac{1}{2}$
17	50BS17HT	3.72	1	1.7	$\frac{5}{8} - \frac{3}{4} - \frac{7}{8} - 1 - 1\frac{1}{2} - 1\frac{5}{8} - 1\frac{1}{4} - 1\frac{1}{2} - 1\frac{5}{8} - 1\frac{1}{2} - 1\frac{1}{2}$
18	50BS18HT	3.92	1	2.0	$\frac{5}{8} - \frac{3}{4} - \frac{7}{8} - 1 - 1\frac{1}{2} - 1\frac{5}{8} - 1\frac{1}{4} - 1\frac{1}{2} - 1\frac{5}{8} - 1\frac{1}{2} - 1\frac{1}{2}$
19	50BS19HT	4.12	1	2.2	$\frac{3}{4} - \frac{7}{8} - 1 - 1\frac{1}{2} - 1\frac{5}{8} - 1\frac{1}{4} - 1\frac{1}{2} - 1\frac{5}{8} - 1\frac{1}{2} - 1\frac{1}{2}$
20	50BS20HT	4.32	1	2.5	$\frac{3}{4} - \frac{7}{8} - 1 - 1\frac{1}{2} - 1\frac{5}{8} - 1\frac{1}{4} - 1\frac{1}{2} - 1\frac{5}{8} - 1\frac{1}{2} - 1\frac{1}{2}$
21	50BS21HT	4.52	1	2.6	$\frac{3}{4} - 1 - 1\frac{1}{2} - 1\frac{5}{8} - 1\frac{1}{4} - 1\frac{1}{2} - 1\frac{5}{8} - 1\frac{1}{2}$
22	50BS22HT	4.72	1	2.8	$\frac{3}{4} - 1 - 1\frac{1}{2} - 1\frac{5}{8} - 1\frac{1}{4} - 1\frac{1}{2} - 1\frac{5}{8} - 1\frac{1}{2}$
23	50BS23HT	4.92	1	3.2	$\frac{3}{4} - 1 - 1\frac{1}{2} - 1\frac{5}{8} - 1\frac{1}{4} - 1\frac{1}{2} - 1\frac{5}{8} - 1\frac{1}{2}$
24	50BS24HT	5.12	1 1/4	4.0	$\frac{3}{4} - 1 - 1\frac{1}{2} - 1\frac{5}{8} - 1\frac{1}{4} - 1\frac{1}{2} - 1\frac{5}{8} - 1\frac{1}{2}$

★ Indicates no keyway. (2) 1/4" setscrews only in 1/2" & 3/8" bore at 90°.
† Setscrews at 90° and 180° to key.
NOTE: KEYWAY IS ON CENTER LINE OF TOOTH.

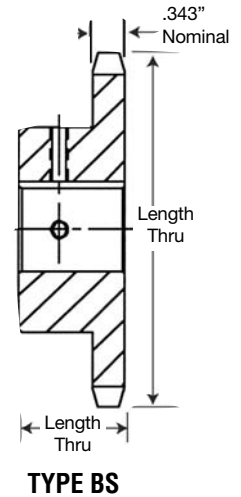

Martin stock hardened teeth sprockets afford longer chain and sprocket life. Hardened teeth on the smaller sprocket of a roller chain drive are recommended if the drive ratio is four to one or greater or if the smaller sprocket has 24 teeth or less and is running at a speed of over 600 R.P.M.

Single-Type C — Steel

No. Teeth	Catalog Number	Outside Diameter	Bore (inches)		Hub (inches)		Weight (Approx.)
			Stock	Rec. Max.	Lbs. Diameter	Length	
12	50C12	2.710	5/8	1 1/4	2*	1	1.25
13	50C13	2.910	5/8	1 5/8	1 1/2	1	1.47
14	50C14	3.110	5/8	1 7/8	2	1	1.69
15	50C15	3.320	5/8	2	2 1/2	1	1.94
16	50C16	3.520	5/8	2 1/4	3	1	2.42
17	50C17	3.720	5/8	2 1/2	3 1/4	1	2.75
18	50C18	3.920	5/8	2 3/4	4	1	3.25
19	50C19	4.120	5/8	3	4 1/4	1	3.87
20	50C20	4.320	5/8	3 1/4	5	1	4.40

* Has recessed groove in hub for chain clearance.

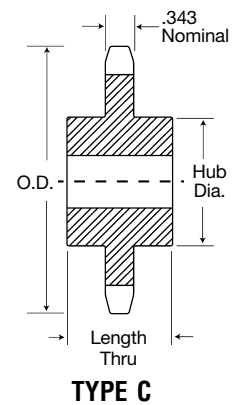

Martin

All Steel Stock Sprockets

No. 50

5/8" Pitch



SPROCKETS

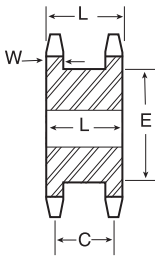

TYPE A

Double Single-Type A — Steel

No. Teeth	Catalog Number	Diameters		Type	Min. Bore	Max. Bore	Dimensions				Wt. (Approx.)
		Outside Diameter	Pitch Diameter				L	C	E	w Nom.	
15	DS50A15	3.320	3.006	A	5/8	1 1/2	1 21/32	1 1/16	2 3/8	.343	2.1
16	DS50A16	3.520	3.204	A	5/8	1 11/16	1 21/32	1 1/16	2 31/64	.343	2.4
17	DS50A17	3.720	3.401	A	5/8	1 3/4	1 21/32	1 1/16	2 11/16	.343	2.9
18	DS50A18	3.920	3.599	A	5/8	1 7/8	1 21/32	1 1/16	2 5/8	.343	3.3
19	DS50A19	4.120	3.797	A	5/8	2 1/8	1 21/32	1 1/16	3 1/8	.343	3.7
20	DS50A20	4.320	3.995	A	5/8	2 1/4	1 21/32	1 1/16	3 3/8	.343	4.2
21	DS50A21	4.520	4.194	A	5/8	2 1/2	1 21/32	1 1/16	3 3/4	.343	4.8
22	DS50A22	4.720	4.392	A	5/8	2 5/8	1 21/32	1 1/16	3 7/8	.343	5.3
23	DS50A23	4.920	4.590	A	5/8	2 3/4	1 21/32	1 1/16	3 7/8	.343	5.8
24	DS50A24	5.120	4.788	A	5/8	2 7/8	1 21/32	1 1/16	4 1/8	.343	6.3

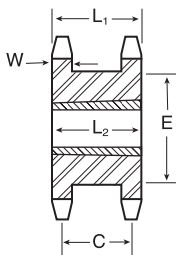

**TAPER BUSH
TYPE A**

Double Single-Taper Bushed — Steel

No. Teeth	Catalog Number	Bushing Size	Diameters		Min. Bore	Max. Bore	Type	Dimensions					Wt. Rim Only
			Outside Diameter	Pitch Diameter				L ₁	C	E	L ₂	w Nom.	
16	DS50ATB16H	1215	3.520	3.204	1/2	1 1/8	A	1 21/32	1 1/16	2 31/64	1 1/2	.343	3.0
17	DS50ATB17H	1615	3.720	3.401	1/2	1 1/4	A	1 21/32	1 1/16	2 11/16	1 1/2	.343	1.8
18	DS50ATB18H	1615	3.920	3.599	1/2	1 1/2	A	1 21/32	1 1/16	2 5/8	1 1/2	.343	2.2
19	DS50ATB19H	1615	4.120	3.797	1/2	1 3/4	A	1 21/32	1 1/16	3 1/8	1 1/2	.343	2.7
20	DS50ATB20H	1615	4.320	3.995	1/2	1 7/8	A	1 21/32	1 1/16	3 3/8	1 1/2	.343	5.0
21	DS50ATB21H	2012	4.520	4.194	1/2	2	A	1 21/32	1 1/16	3 3/4	1 1/2	.343	3.3
23	DS50ATB23H	2012	4.920	4.590	1/2	2 1/4	A	1 21/32	1 1/16	3 7/8	1 1/2	.343	3.7
24	DS50ATB24H	2012	5.120	4.788	1/2	2 1/2	A	1 21/32	1 1/16	4 1/8	1 1/2	.343	4.1

Sprockets with "H" suffix have hardened teeth.

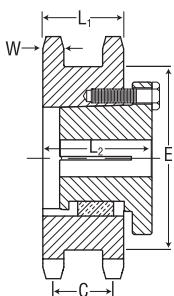

**MST
TYPE B**

Double Single- MST® — Steel

No. Teeth	Catalog Number	Bushing Size	Diameters		Min. Bore	Max. Bore	Type	Dimensions					Wt. Rim Only
			Outside Diameter	Pitch Diameter				L ₁	C	E	L ₂	w Nom.	
17	DS50H17H	H	3.720	3.401	5/8	1 1/2	BH	1 21/32	1 1/16	2 11/16	2 3/8	.343	2.3
19	DS50P19H	P1	4.120	3.797	1/2	1 3/4	B	1 21/32	1 1/16	3 3/8	2 11/32	.343	2.8
21	DS50P21H	P1	4.520	4.194	1/2	1 7/8	B	1 21/32	1 1/16	3 3/4	2 17/32	.343	3.8
23	DS50P23H	P1	4.920	4.590	1/2	1 7/8	B	1 21/32	1 1/16	3 7/8	2 17/32	.343	4.6
24	DS50P24H	P1	5.120	4.788	1/2	1 7/8	B	1 21/32	1 1/16	4 1/8	2 17/32	.343	5.0

Sprockets with "H" suffix have hardened teeth.

No. 50
5/8" Pitch

Stainless Steel
Stock Sprockets

Martin

Single-Type B — Stainless

Single-Type A

No. Teeth	Catalog Number	Outside Diameter	Type	Bore (inches)		Hub (inches)		Weight Lbs. (Approx.)	Type	Catalog Number	Stock Bore	Lbs. (Approx.)
				Stock	Rec. Max.	Diameter	Length Thru					
10	50B10SS	2.300	B	5/8	3/4	1 1/8*	1	.5				
11	50B11SS	2.500	B	5/8	1	1 1/4*	1	.6				
12	50B12SS	2.710	B	5/8	1 1/4	1 5/8*	1	.7				
13	50B13SS	2.910	B	5/8	1 1/2	1 7/8	1	.8				
14	50B14SS	3.110	B	5/8	1 5/8	2	1	1.0				
15	50B15SS	3.320	B	5/8	1 3/4	2 1/8	1	1.3				
16	50B16SS	3.520	B	5/8	1 7/8	2 1/4	1	1.5				
17	50B17SS	3.720	B	5/8	2	2 1/2	1	1.8				
18	50B18SS	3.920	B	5/8	2 1/8	2 3/4	1	2.0				
19	50B19SS	4.120	B	5/8	2 1/4	3	1	2.3				
20	50B20SS	4.320	B	3/4	2 1/2	3	1	2.5				
21	50B21SS	4.520	B	3/4	2 3/4	3 1/2	1	2.7	A	50A21SS	2 3/32	1.4
22	50B22SS	4.720	B	3/4	3	3 1/2	1	3.3	A	50A22SS	2 3/32	1.6
23	50B23SS	4.920	B	3/4	3 1/4	3 3/4	1	3.8	A	50A23SS	2 3/32	1.7
24	50B24SS	5.120	B	3/4	3 1/2	4	1 1/4	4.1	A	50A24SS	2 3/32	1.8
25	50B25SS	5.320	B	3/4	3 3/4	4 1/4	1 1/4	4.3	A	50A25SS	2 3/32	1.9
26	50B26SS	5.520	B	3/4	4	4 1/2	1 1/4	4.6	A	50A26SS	2 3/32	1.7
28	50B28SS	5.920	B	3/4	4 1/2	5	1 1/4	5.0	A	50A28SS	2 3/32	2.5
30	50B30SS	6.320	B	3/4	4 3/4	5 1/2	1 1/4	5.2	A	50A30SS	2 7/32	2.7
35	50B35SS	7.320	B	3/4	5 1/2	6 1/2	1 1/4	6.5	A	50A35SS	2 7/32	3.7
40	50B40SS	8.320	B	3/4	6 1/4	7 1/2	1 1/4	7.8	A	50A40SS	2 7/32	4.7
45	50B45SS	9.310	B	3/4	7 1/2	8 1/2	1 1/4	8.5	A	50A45SS	2 7/32	6.0
60	50B60SS	12.300	B	1	9 1/2	11 1/2	1 1/4	14.0	A	50A60SS	1 1/16	10.8

* Has recessed groove in hub for chain clearance.

Maximum bores shown will accommodate standard keyseat and setscrew over keyseat. Slightly larger bores are possible with no keyseat, shallow keyseat, or setscrew at angle to keyseat.

Sprockets altered at factory (rebored with keyway and setscrew added) will be supplied with stainless setscrew.

SPROCKETS



STAINLESS STEEL

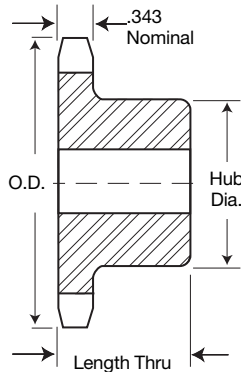

TYPE B

Alteration Charges

See current discount sheet for alteration charges.

Single-Type B

Single-Type A

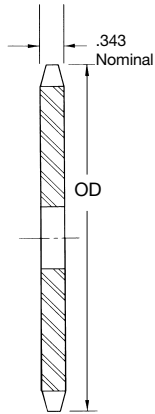

TYPE A

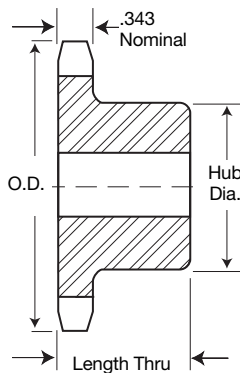

TYPE B

No. Teeth	Catalog Number	Outside Diameter	Type	Bore (inches)		Hub (inches)		Weight Lbs. (Approx.)	Type	Catalog Number	Stock Bore	Weight Lbs. (Approx.)
				Stock	Rec. Max.	Diameter	Length Thru					
8	50B8	1.880	B	%	%	1 1/8*	1	.25				
9	50B9	2.090	B	%	%	1 1/8*	1	.36				
10	50B10	2.300	B	%	%	1 1/8*	1	.48				
11	50B11	2.500	B	%	1	1 1/8*	1	.64				
12	50B12	2.710	B	%	1 1/16	1 5/16*	1	.83	A	50A12	%	.34
13	50B13	2.910	B	%	1 1/16	1 1/2	1	.88	A	50A13	%	.42
14	50B14	3.110	B	%	1 1/16	2 1/8	1	1.13	A	50A14	%	.50
15	50B15	3.320	B	%	1 1/2	2 1/8	1	1.34	A	50A15	%	.54
16	50B16	3.520	B	%	1 1/2	2 1/2	1	1.51	A	50A16	%	.68
17	50B17	3.720	B	%	1 1/2	2 1/2	1	1.74	A	50A17	%	.76
18	50B18	3.920	B	%	1 1/2	2 1/2	1	2.00	A	50A18	%	.86
19	50B19	4.120	B	%	2	3	1	2.22	A	50A19	%	.94
20	50B20	4.320	B	%	2	3	1	2.28	A	50A20	%	1.06
21	50B21	4.520	B	%	2	3	1	2.40	A	50A21	%	1.12
22	50B22	4.720	B	%	2	3	1	2.56	A	50A22	%	1.30
23	50B23	4.920	B	%	2	3	1	2.66	A	50A23	%	1.44
24	50B24	5.120	B	%	2	3	1 1/4	3.30	A	50A24	2 3/32	1.50
25	50B25	5.320	B	%	2	3	1 1/4	3.40	A	50A25	2 3/32	1.62
26	50B26	5.520	B	%	2	3	1 1/4	3.44	A	50A26	2 3/32	1.72
27	50B27	5.720	B	%	2	3	1 1/4	3.74	A	50A27	2 3/32	1.96
28	50B28	5.920	B	%	2	3	1 1/4	3.80	A	50A28	2 3/32	2.04
29	50B29	6.120	B	%	2	3	1 1/4	4.06	A	50A29	2 3/32	2.36
30	50B30	6.320	B	%	2 1/4	3 1/4	1 1/4	4.56	A	50A30	2 3/32	2.54
31	50B31	6.520	B	%	2 1/4	3 1/4	1 1/4	4.74	A	50A31	2 3/32	2.80
32	50B32	6.720	B	%	2 1/4	3 1/4	1 1/4	4.96	A	50A32	2 3/32	2.72
33	50B33	6.920	B	%	2 1/4	3 1/4	1 1/4	5.20	A	50A33	2 3/32	3.14
34	50B34	7.120	B	%	2 1/4	3 1/4	1 1/4	5.14	A	50A34	2 3/32	3.20
35	50B35	7.320	B	%	2 1/4	3 1/4	1 1/4	5.44	A	50A35	2 3/32	3.34
36	50B36	7.520	B	%	2 1/4	3 1/4	1 1/4	5.64	A	50A36	2 3/32	3.82
37	50B37	7.720	B	%	2 1/4	3 1/4	1 1/4	5.90	A	50A37	2 3/32	3.98
38	50B38	7.920	B	%	2 1/4	3 1/4	1 1/4	6.08	A	50A38	2 3/32	4.14
39	50B39	8.120	B	%	2 1/4	3 1/4	1 1/4	6.30	A	50A39	2 3/32	4.42
40	50B40	8.320	B	%	2 1/4	3 1/4	1 1/4	6.50	A	50A40	2 3/32	4.46
41	50B41	8.520	B	%	2 1/4	3 1/4	1 1/4	6.64	A	50A41	2 3/32	4.86
42	50B42	8.720	B	%	2 1/4	3 1/4	1 1/4	6.96	A	50A42	2 3/32	4.98
43	50B43	8.910	B	%	2 1/4	3 1/4	1 1/4	7.06	A	50A43	2 3/32	5.24
44	50B44	9.110	B	%	2 1/4	3 1/4	1 1/4	7.58	A	50A44	2 3/32	5.42
45	50B45	9.310	B	%	2 1/4	3 1/4	1 1/4	8.58	A	50A45	2 3/32	5.92
46	50B46	9.510	B	1	2 1/2	3 1/4	1 1/4	8.22	A	50A46	1 5/16	6.42
47	50B47	9.710	B	1	2 1/2	3 1/4	1 1/4	8.48	A	50A47	1 5/16	6.50
48	50B48	9.910	B	1	2 1/2	3 1/4	1 1/4	9.28	A	50A48	1 5/16	6.58
49	50B49	10.110	B	1	2 1/2	3 1/4	1 1/4	9.22	A	50A49	1 5/16	7.06
50	50B50	10.310	B	1	2 1/2	3 1/4	1 1/4	9.88	A	50A50	1 5/16	7.10
51	50B51	10.510	B	1	2 1/2	3 1/4	1 1/4	9.70	A	50A51	1 5/16	7.32
52	50B52	10.710	B	1	2 1/2	3 1/4	1 1/4	10.24	A	50A52	1 5/16	7.98
53	50B53	10.910	B	1	2 1/2	3 1/4	1 1/4	10.48	A	50A53	1 5/16	8.08
54	50B54	11.110	B	1	2 1/2	3 1/4	1 1/4	11.00	A	50A54	1 5/16	8.30
55	50B55	11.310	B	1	2 1/2	3 1/4	1 1/4	10.93	A	50A55	1 5/16	8.56
56	50B56	11.500	B	1	2 1/2	3 1/4	1 1/4	11.50	A	50A56	1 5/16	8.90
57	50B57	11.700	B	1	2 1/2	3 1/4	1 1/4	12.00	A	50A57	1 5/16	9.38
58	50B58	11.900	B	1	2 1/2	3 1/4	1 1/4	11.82	A	50A58	1 5/16	10.30
59	50B59	12.100	B	1	2 1/2	3 1/4	1 1/4	12.32	A	50A59	1 5/16	10.50
60	50B60	12.300	B	1	2 1/2	3 1/4	1 1/4	13.00	A	50A60	1 5/16	10.80
70	50B70	14.290	B	1	2 1/2	3 1/4	1 1/4	18.16	A	50A70	1 5/16	14.00
72	50B72	14.690	B	1	2 1/2	3 1/4	1 1/4	19.48	A	50A72	1 5/16	15.24
76	50B76	15.486	B	1	2 1/2	3 1/4	1 1/4	21.00	A	50A76	1 5/16	20.08
80	50B80	16.280	B	1	2 3/4	4 1/4	1 1/4	24.74	A	50A80	1 5/16	21.00
84	50B84	17.080	B	1	2 3/4	4 1/4	1 1/4	25.50	A	50A84	1 5/16	22.08
95	50B95	19.270	B	1	2 3/4	4 1/4	1 1/4	32.00	A	50A95	1 5/16	27.00
96	50B96	19.470	B	1	2 3/4	4 1/4	1 1/4	32.92	A	50A96	1 5/16	27.40
112	50B112	22.650	B	1	2 3/4	4 1/4	1 1/4	42.00	A	50A112	1 5/16	37.70

* Has recessed groove in hub for chain clearance.

Maximum bores shown will accommodate standard keyseat and setscrew over keyseat. Slightly larger bores are possible with no keyseat, shallow keyseat, or setscrew at angle to keyseat.

Alteration Charges

See current discount sheet for alteration charges.

No. 50
5/8" Pitch

All Steel
Stock Sprockets

Martin

Single-Type QD With Hardened Teeth

No. Teeth	Catalog Number
12	50JA12H
13	50JA13H
14	50JA14H
15	50JA15H
16	50JA16H
17	50SH17H
18	50SH18H
19	50SH19H
20	50SDS20H
21	50SDS21H
22	50SDS22H
23	50SDS23H
24	50SDS24H
25	50SDS25H
26	50SDS26H
27	50SDS27H
28	50SDS28H
30	50SDS30H

SABER
TOOTH®

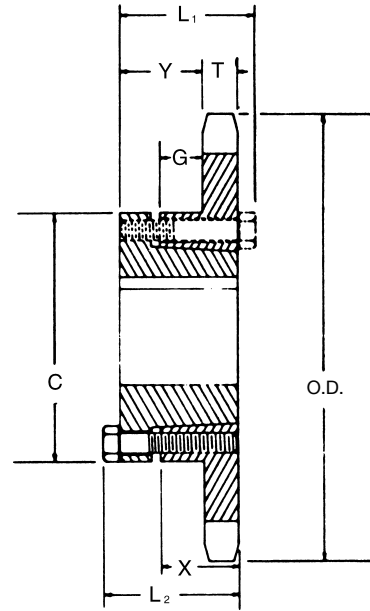

QD — TYPE B

Single-Type QD

No. Teeth	Catalog Number	Bush- ing	Diameters		Type	Max. Bore	Dimensions							Weight (Approx.)	
			Outside Diameter	Pitch Diameter			L ₁	L ₂	C	Y	G	X	T	With Hub	Rim Only
12	50JA12	JA	2.710	2.415	B	1 1/4	1 1/8	1 1/8	2 1/16	2 1/32	9/32	5/8	.343	1.24	.34
13	50JA13	JA	2.910	2.612	B									1.30	.40
14	50JA14	JA	3.110	2.803	B									1.45	.52
15	50JA15	JA	3.320	3.006	B									1.50	.60
16	50JA16	JA	3.520	3.204	B	1 1/4	1 1/8	1 1/8	2 1/16	2 1/32	9/32	5/8	.343	1.58	.68
17	50SH17	SH	3.720	3.401	B	1 1/4	1 1/16	1 1/16	2 1/16	2 1/32	15/32	13/16	.343	1.84	.84
18	50SH18	SH	3.920	3.599	B	1 1/4	1 1/8	1 1/8	2 1/16	2 1/32	15/32	13/16	.343	2.04	1.04
19	50SH19	SH	4.120	3.797	B	1 1/4	1 1/8	1 1/8	2 1/16	2 1/32	15/32	13/16	.343	2.24	1.24
20	50SDS20	SDS	4.320	3.995	B	2	1 1/2	1 1/2	3 1/16	3 1/32	1 1/2	3/4	.343	2.20	1.20
21	50SDS21	SDS	4.520	4.194	B									2.32	1.32
22	50SDS22	SDS	4.720	4.392	B									2.48	1.42
23	50SDS23	SDS	4.920	4.590	B									2.58	1.58
24	50SDS24	SDS	5.120	4.788	B									2.70	1.70
25	50SDS25	SDS	5.320	4.987	B									2.86	1.86
26	50SDS26	SDS	5.520	5.185	B									3.00	2.00
27	50SDS27	SDS	5.720	5.384	B									3.12	2.12
28	50SDS28	SDS	5.920	5.582	B									3.32	2.32
30	50SDS30	SDS	6.320	5.979	B									3.64	2.64
32	50SDS32	SDS	6.720	6.376	B									3.98	2.98
35	50SDS35	SDS	7.320	6.972	B									4.62	3.62
36	50SDS36	SDS	7.520	7.171	B									4.64	3.64
40	50SDS40	SDS	8.320	7.966	B									5.74	4.74
42	50SDS42	SDS	8.720	8.363	B									6.40	5.40
45	50SDS45	SDS	9.310	8.960	B									6.90	5.90
48	50SDS48	SDS	9.910	9.556	B	2	1 1/2	1 1/2	3 1/16	3 1/32	1 1/2	3/4	.343	7.66	6.66
54	50SK54	SK	11.110	10.749	B	2 1/2	2 1/2	2 1/2	3 3/8	1 1/2	2 1/2	1 1/4	.343	11.68	9.68
60	50SK60	SK	12.300	11.942	B									13.88	11.88
70	50SK70	SK	14.290	13.931	B									17.52	15.52
72	50SK72	SK	14.690	14.329	B	2 1/2	2 1/2	2 1/2	3 3/8	1 1/2	2 1/2	1 1/4	.343	18.44	16.44
80	50SF80	SF	16.280	15.920	B	2 1/2	2 1/4	2 1/4	4 1/8	1 1/2	2 1/2	1 1/4	.343	22.90	19.90
84	50SF84	SF	17.080	16.715	B									25.98	22.98
96	50SF96	SF	19.470	19.102	B									32.88	29.88
112	50SF112	SF	22.650	22.285	B	2 1/2	2 1/4	2 1/4	4 1/8	1 1/2	2 1/2	1 1/4	.343	43.10	40.10

Single-Taper Bushed with Hardened Teeth

No. Teeth	Catalog Number
12	50BTB12H
13	50BTB13H
14	50BTB14H
15	50BTB15H
16	50BTB16H
17	50BTB17H
18	50BTB18H
19	50BTB19H
20	50BTB20H
21	50BTB21H
22	50BTB22H
23	50BTB23H
24	50BTB24H
25	50BTB25H
26	50BTB26H
27	50BTB27H
28	50BTB28H
30	50BTB30H

**SABER
TOOTH®**

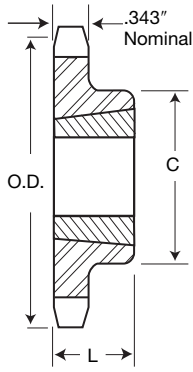

TYPE B

SPROCKETS

Single-Taper Bushed

No. Teeth	Catalog Number	Bushing	Diameter		Max. Bore	Dimensions		Type	Weight (Approx.)	
			Outside Diameter	Pitch Diameter		L	C		Rim Only	Bushing Only
12	50BTB12	1008	2.708	2.415	1	7/8	1 1/16*	B	.5	.3
13	50BTB13	1008	2.911	2.612	1	7/8	1 1/16	B	.5	.3
14	50BTB14	1008	3.113	2.809	1	7/8	1 1/16	B	.6	.3
15	50BTB15	1210	3.315	3.006	1 1/4	1	2 1/32*	B	.7	.6
16	50BTB16	1610	3.517	3.204	1 1/2	1	2 7/32*	B	.7	.9
17	50BTB17	1610	3.719	3.401	1 1/2	1	2 7/32*	B	.8	.9
18	50BTB18	1610	3.920	3.599	1 1/2	1	2 7/32	B	.9	.9
19	50BTB19	1610	4.120	3.797	1 1/2	1	3	B	1.3	.9
20	50BTB20	1610	4.321	3.995	1 1/2	1	3 1/2	B	1.6	.9
21	50BTB21	1610	4.522	4.193	1 1/2	1	3 1/2	B	1.5	.9
22	50BTB22	1610	4.722	4.392	1 1/2	1	3 1/2	B	1.6	.9
23	50BTB23	2012	4.922	4.590	2	1 1/4	3 3/8	B	2.0	1.7
24	50BTB24	2012	5.122	4.788	2	1 1/4	4	B	2.2	1.7
25	50BTB25	2012	5.322	4.987	2	1 1/4	4	B	2.4	1.7
26	50BTB26	2012	5.522	5.185	2	1 1/4	4	B	2.5	1.7
27	50BTB27	2012	5.723	5.384	2	1 1/4	4	B	2.6	1.7
28	50BTB28	2012	5.922	5.582	2	1 1/4	4	B	2.8	1.7
30	50BTB30	2012	6.321	5.979	2	1 1/4	3 3/8	B	3.2	1.7
32	50BTB32	2012	6.721	6.376	2	1 1/4	3 3/8	B	3.6	1.7
35	50BTB35	2012	7.319	6.972	2	1 1/4	3 3/8	B	4.2	1.7
36	50BTB36	2012	7.519	7.171	2	1 1/4	3 3/8	B	4.3	1.7
40	50BTB40	2012	8.316	7.966	2	1 1/4	3 3/8	B	5.2	1.7
42	50BTB42	2012	8.715	8.363	2	1 1/4	3 3/8	B	5.9	1.7
45	50BTB45	2012	9.313	8.960	2	1 1/4	3 3/8	B	6.5	1.7
48	50BTB48	2012	9.911	9.556	2	1 1/4	3 3/8	B	7.3	1.7
54	50BTB54	2012	11.106	10.749	2	1 1/4	3 3/8	B	9.0	1.7
60	50BTB60	2012	12.301	11.942	2	1 1/4	3 3/8	B	10.8	1.7
70	50BTB70	2517	14.292	13.931	2 1/2	1 3/4	4 1/4	B	14.0	3.5
72	50BTB72	2517	14.690	14.329	2 1/2	1 3/4	4 1/4	B	15.5	3.5
80	50BTB80	2517	16.282	15.920	2 1/2	1 3/4	4 1/4	B	19.5	3.5
84	50BTB84	2517	17.079	16.715	2 1/2	1 3/4	4 1/4	B	22.5	3.5
96	50BTB96	2517	19.466	19.102	2 1/2	1 3/4	4 1/4	B	29.0	3.5
112	50BTB112	2517	22.651	22.285	2 1/2	1 3/4	4 1/4	B	38.7	3.5

* Has recessed groove in hub for chain clearance.

No. 50

5/8" Pitch

MST[®] Sprockets

Martin

Single - MST[®] Sprockets

No. Teeth	Catalog Number	Bush-ing	Diameters		Type	Max. Bore	Dimensions						Weight (Approx.)	
			Outside Dia.	Pitch Dia.			OL	L	C	H	P	T(nom)	With Hub	Rim Only
13	50H13H	H	2.910	2.612	3	1 1/2	1 21/32	1 1/4	7/32	2 1/2	1 1/8	.343	1.4	.6
14	50H14H	H	3.110	2.809	3	1 1/2	1 19/32	1 1/4	5/32	2 1/2	1 1/16	.343	1.4	.6
15	50H15H	H	3.320	3.006	3	1 1/2	1 1/2	1 1/4	1/16	2 1/2	31/32	.343	1.6	.8
15	50P15H	P1	3.320	3.006	4	1 3/4	2 3/16	1 15/16	0	3	1 19/32	.343	2.4	1.1
16	50H16H	H	3.520	3.204	3	1 1/2	1 1/2	1 1/4	1/16	2 1/2	31/32	.343	1.7	.9
16	50P16H	P1	3.520	3.204	4	1 3/4	2 3/16	1 15/16	0	3	1 19/32	.343	2.7	1.4
17	50H17H	H	3.720	3.401	3	1 1/2	1 1/2	1 1/4	1/16	2 1/2	31/32	.343	1.8	1.0
17	50P17H	P1	3.720	3.401	4	1 3/4	2 3/16	1 15/16	0	3	1 19/32	.343	2.7	1.4
18	50H18H	H	3.920	3.599	3	1 1/2	1 1/2	1 1/4	1/16	2 1/2	31/32	.343	1.9	1.1
18	50P18H	P1	3.920	3.599	4	1 3/4	2 3/16	1 15/16	0	3	1 19/32	.343	3.1	1.8
19	50H19H	H	4.120	3.797	3	1 1/2	1 1/2	1 1/4	1/16	2 1/2	31/32	.343	2.1	1.3
19	50P19H	P1	4.120	3.797	4	1 3/4	2 3/16	1 15/16	0	3	1 19/32	.343	3.1	1.8
20	50H20H	H	4.320	3.995	3	1 1/2	1 1/2	1 1/4	1/16	2 1/2	31/32	.343	2.3	1.5
20	50P20H	P1	4.320	3.995	4	1 3/4	2 3/16	1 15/16	0	3	1 19/32	.343	3.3	2.0
21	50H21H	H	4.520	4.194	3	1 1/2	1 1/2	1 1/4	1/16	2 1/2	31/32	.343	2.2	1.4
21	50P21H	P1	4.520	4.194	4	1 3/4	2 3/16	1 15/16	0	3	1 19/32	.343	3.4	2.1
22	50H22H	H	4.720	4.392	3	1 1/2	1 1/2	1 1/4	1/16	2 1/2	31/32	.343	2.3	1.5
22	50P22H	P1	4.720	4.392	4	1 3/4	2 3/16	1 15/16	0	3	1 19/32	.343	3.5	2.2
23	50H23H	H	4.920	4.590	3	1 1/2	1 1/2	1 1/4	1/16	2 1/2	31/32	.343	2.5	1.7
23	50P23H	P1	4.920	4.590	4	1 3/4	2 3/16	1 15/16	0	3	1 19/32	.343	3.7	2.4
23	50Q23H	Q1	4.920	4.590	4	2 11/16	2 25/32	2 1/2	0	4 1/8	2 5/32	.343	6.7	3.2
24	50H24H	H	5.120	4.788	3	1 1/2	1 1/2	1 1/4	1/16	2 1/2	31/32	.343	2.6	1.8
24	50P24H	P1	5.120	4.788	4	1 3/4	2 3/16	1 15/16	0	3	1 19/32	.343	3.9	2.6
24	50Q24H	Q1	5.120	4.788	4	2 11/16	2 25/32	2 1/2	0	4 1/8	2 5/32	.343	7.0	3.5
25	50H25H	H	5.320	4.987	3	1 1/2	1 1/2	1 1/4	1/16	2 1/2	31/32	.343	2.7	1.9
25	50P25H	P1	5.320	4.987	4	1 3/4	2 3/16	1 15/16	0	3	1 19/32	.343	4.0	2.7
25	50Q25H	Q1	5.320	4.987	4	2 11/16	2 25/32	2 1/2	0	4 1/8	2 5/32	.343	7.1	3.6
26	50H26H	H	5.520	5.185	3	1 1/2	1 1/2	1 1/4	1/16	2 1/2	31/32	.343	2.8	2.0
26	50P26H	P1	5.520	5.185	4	1 3/4	2 3/16	1 15/16	0	3	1 19/32	.343	4.1	2.8
26	50Q26H	Q1	5.520	5.185	4	2 11/16	2 25/32	2 1/2	0	4 1/8	2 5/32	.343	7.2	3.7
27	50H27H	H	5.720	5.384	3	1 1/2	1 1/2	1 1/4	1/16	2 1/2	31/32	.343	3.0	2.2
27	50P27H	P1	5.720	5.384	4	1 3/4	2 3/16	1 15/16	0	3	1 19/32	.343	4.2	2.9
27	50Q27H	Q1	5.720	5.384	4	2 11/16	2 25/32	2 1/2	0	4 1/8	2 5/32	.343	7.3	3.8
28	50H28H	H	5.920	5.582	3	1 1/2	1 1/2	1 1/4	1/16	2 1/2	31/32	.343	3.3	2.5
28	50P28H	P1	5.920	5.582	4	1 3/4	2 3/16	1 15/16	0	3	1 19/32	.343	4.3	3.0
28	50Q28H	Q1	5.920	5.582	4	2 11/16	2 25/32	2 1/2	0	4 1/8	2 5/32	.343	7.5	4.0
29	50P29H	P1	6.120	5.781	4	1 3/4	2 3/16	1 15/16	0	3	1 19/32	.343	4.7	3.4
30	50H30H	H	6.320	5.979	3	1 1/2	1 1/2	1 1/4	1/16	2 1/2	31/32	.343	3.7	2.9
30	50P30H	P1	6.320	5.979	4	1 3/4	2 3/16	1 15/16	0	3	1 19/32	.343	4.9	3.6
30	50Q30H	Q1	6.320	5.979	4	2 11/16	2 25/32	2 1/2	0	4 1/8	2 5/32	.343	9.1	5.6
31	50P31	P1	6.520	6.178	4	1 3/4	2 3/16	1 15/16	0	3	1 19/32	.343	4.9	3.6
32	50H32H	H	6.720	6.376	3	1 1/2	1 1/2	1 1/4	1/16	2 1/2	31/32	.343	4.0	3.2
32	50P32	P1	6.720	6.376	4	1 3/4	2 3/16	1 15/16	0	3	1 19/32	.343	5.2	3.9
32	50Q32	Q1	6.720	6.376	4	2 11/16	2 25/32	2 1/2	0	4 1/8	2 5/32	.343	9.6	6.1
33	50H33H	H	6.920	6.575	3	1 1/2	1 1/2	1 1/4	1/16	2 1/2	31/32	.343	4.2	3.4
33	50P33	P1	6.920	6.575	4	1 3/4	2 3/16	1 15/16	0	3	1 19/32	.343	5.4	4.1
34	50H34H	H	7.120	6.774	3	1 1/2	1 1/2	1 1/4	1/16	2 1/2	31/32	.343	4.5	3.7
34	50P34	P1	7.120	6.774	4	1 3/4	2 3/16	1 15/16	0	3	1 19/32	.343	5.6	4.3
35	50H35H	H	7.320	6.972	3	1 1/2	1 1/2	1 1/4	1/16	2 1/2	31/32	.343	4.6	3.8
35	50P35	P1	7.320	6.972	4	1 3/4	2 3/16	1 15/16	0	3	1 19/32	.343	5.6	4.3
35	50Q35	Q1	7.320	6.972	4	2 11/16	2 25/32	2 1/2	0	4 1/8	2 5/32	.343	10.3	6.8
36	50H36H	H	7.520	7.171	3	1 1/2	1 1/2	1 1/4	1/16	2 1/2	31/32	.343	4.8	4.0
36	50P36	P1	7.520	7.171	4	1 3/4	2 3/16	1 15/16	0	3	1 19/32	.343	6.1	4.8
36	50Q36	Q1	7.520	7.171	4	2 11/16	2 25/32	2 1/2	0	4 1/8	2 5/32	.343	10.3	6.8
37	50Q37	Q1	7.720	7.370	4	2 11/16	2 25/32	2 1/2	0	4 1/8	2 5/32	.343	10.5	7.0
38	50H38H	H	7.920	7.569	3	1 1/2	1 1/2	1 1/4	1/16	2 1/2	31/32	.343	5.2	4.4
38	50Q38	Q1	7.920	7.569	4	2 11/16	2 25/32	2 1/2	0	4 1/8	2 5/32	.343	10.9	7.4
39	50Q39	Q1	8.120	7.767	4	2 11/16	2 25/32	2 1/2	0	4 1/8	2 5/32	.343	11.1	7.6
40	50H40H	H	8.320	7.966	3	1 1/2	1 1/2	1 1/4	1/16	2 1/2	31/32	.343	5.6	4.8
40	50Q40	Q1	8.320	7.966	4	2 11/16	2 25/32	2 1/2	0	4 1/8	2 5/32	.343	11.5	8.0
41	50Q41	Q1	8.520	8.165	4	2 11/16	2 25/32	2 1/2	0	4 1/8	2 5/32	.343	11.7	8.2
42	50Q42	Q1	8.720	8.363	4	2 11/16	2 25/32	2 1/2	0	4 1/8	2 5/32	.343	11.8	8.3
44	50Q44	Q1	9.110	8.761	4	2 11/16	2 25/32	2 1/2	0	4 1/8	2 5/32	.343	12.1	8.6
45	50Q45	Q1	9.310	8.960	4	2 11/16	2 25/32	2 1/2	0	4 1/8	2 5/32	.343	12.5	9.0
47	50Q47	Q1	9.710	9.357	4	2 11/16	2 25/32	2 1/2	0	4 1/8	2 5/32	.343	12.8	9.3
48	50Q48	Q1	9.910	9.556	4	2 11/16	2 25/32	2 1/2	0	4 1/8	2 5/32	.343	13.1	9.6
50	50Q50	Q1	10.310	9.954	4	2 11/16	2 25/32	2 1/2	0	4 1/8	2 5/32	.343	13.3	9.8
54	50Q54	Q1	11.110	10.749	4	2 11/16	2 25/32	2 1/2	0	4 1/8	2 5/32	.343	14.8	11.3
56	50Q56	Q1	11.500	11.147	4	2 11/16	2 25/32	2 1/2	0	4 1/8	2 5/32	.343	15.8	12.3
60	50Q60	Q1	12.300	11.942	4	2 11/16	2 25/32	2 1/2	0	4 1/8	2 5/32	.343	16.8	13.3
70	50Q70	Q1	14.290	13.931	4	2 11/16	2 25/32	2 1/2	0	4 1/8	2 5/32	.343	20.4	16.9
72	50Q72	Q1	14.690	14.329	4	2 11/16	2 25/32	2 1/2	0	4 1/8	2 5/32	.343	21.6	18.1
80	50Q80	Q1	16.280	15.920	4	2 11/16	2 25/32	2 1/2	0	4 1/8	2 5/32	.343	24.6	21.1
84	50Q84	Q1	17.080	16.715	4	2 11/16	2 25/32	2 1/2	0	4 1/8	2 5/32	.343	27.8	24.3
96	50Q96	Q1	19.470	19.102	4	2 11/16	2 25/32	2 1/2	0	4 1/8	2 5/32	.343	33.3	29.8
112	50Q112	Q1	22.650	22.285	4	2 11/16	2 25/32	2 1/2	0	4 1/8	2 5/32	.343	42.8	39.3

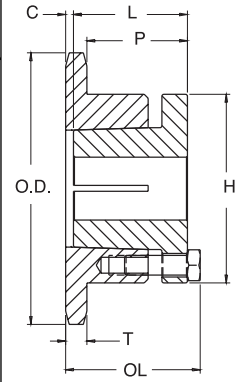

TYPE 3

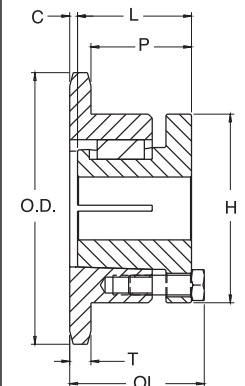

TYPE 4

SPROCKETS

Martin

All Steel Stock Sprockets

No. 50-2

5/8" Pitch

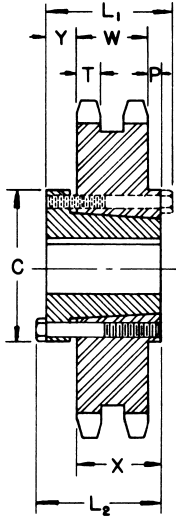

QD — TYPE C

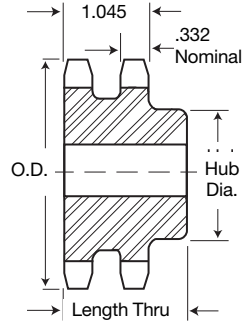

TYPE B

Alteration Charges

See current discount sheet for alteration charges.

Double-Type B

No. Teeth	Catalog Number	Outside Diameter	Type	Bore (inches)		Hub (inches)		Weight Lbs. (Approx.)
				Stock	Rec. Max.	Dia.	Length Thru	
11	D50B11H	2.500	B	5/8	15/16	1 1/32	1 1/8	.96
12	D50B12H	2.710	B	5/8	1 1/8	1 1/16	1 1/8	1.25
13	D50B13H	2.910	B	5/8	1 1/8	1 1/8	1 1/8	1.56
14	D50B14H	3.110	B	5/8	1 1/8	2 1/16	1 1/8	1.86
15	D50B15H	3.320	B	3/4	1 1/2	2 3/16	1 1/8	2.22
16	D50B16H	3.520	B	3/4	1 1/2	2 1/2	1 1/8	2.62
17	D50B17H	3.720	B	3/4	1 1/2	2 11/16	1 1/8	3.04
18	D50B18H	3.920	B	3/4	1 1/2	2 5/8	1 1/8	3.58
19	D50B19H	4.120	B	1	2 1/8	3 1/8	1 1/8	3.90
20	D50B20H	4.320	B	1	2 1/8	3 1/4	1 1/8	4.26
21	D50B21H	4.520	B	1	2 1/8	3 1/2	1 1/8	4.90
22	D50B22H	4.720	B	1	2 1/8	3 5/8	1 1/8	5.58
23	D50B23H	4.920	B	1	2 1/2	3 3/8	1 1/8	6.10
24	D50B24H	5.120	B	1	2 1/2	3 3/4	1 1/8	6.50
25	D50B25H	5.320	B	1	2 1/2	3 3/4	1 1/8	6.94
26	D50B26	5.520	B	1	2 1/2	3 3/4	1 1/8	7.54
30	D50B30	6.320	B	1	2 1/2	3 3/4	1 1/8	9.40
32	D50B32	6.720	B	1	2 1/2	3 3/4	1 1/8	10.46
35	D50B35	7.320	B	1	2 1/2	3 3/4	1 1/8	12.28
36	D50B36	7.520	B	1 1/16	2 1/2	4	2 1/8	13.94
40	D50B40	8.320	B	1 1/16	2 1/2	4	2 1/8	16.54
42	D50B42	8.720	B	1 1/16	2 1/2	4	2 1/8	17.92
45	D50B45	9.310	B	1 1/16	2 1/2	4	2 1/8	20.30
48	D50B48	9.910	B	1 1/16	2 1/2	4 1/4	2 1/8	24.08
52	D50B52	10.710	B	1 1/16	2 1/2	4 1/2	2 1/8	27.42
54	D50B54	11.110	B	1 1/16	2 1/2	4 1/2	2 1/8	29.16
60	D50B60	12.300	B	1 1/16	3	4 1/2	2 1/8	35.88
68	D50B68	13.890	B	1 1/16	3	4 1/2	2 1/8	44.98
72	D50B72	14.690	B	1 1/16	3	4 1/2	2 1/8	50.22
76	D50B76	15.490	B	1 1/16	3	4 1/2	2 1/8	45.64
84	D50B84	17.080	B	1 1/16	3	4 1/2	2 1/8	51.64
95	D50B95	19.270	B	1 1/16	3	4 1/2	2 1/8	64.32
96	D50B96	19.470	B	1 1/16	3	4 1/2	2 1/8	67.42
102	D50B102	20.660	B	1 1/16	3	4 1/2	2 1/8	72.68
112	D50B112	22.650	B	1 1/16	3 3/16	5 1/4	2 1/8	90.22

Maximum bores shown will accommodate standard keyseat and setscrew over keyseat. Slightly larger bores are possible with no keyseat, shallow keyseat, or setscrew at angle to keyseat.

NOTE: Double 50 stock sprockets with 25 teeth or less have hardened teeth. As indicated by H suffix.

Double-Type QD

No. Teeth	Catalog Number	Bush-ing	Diameters		Type	Max. Bore	Dimensions							Weight (Approx.)		
			Outside Diameter	Pitch Diameter			L ₁	L ₂	C	Y	P	X	T	W	With Hub	Rim Only
36	D50SK36	SK	7.520	7.171	C	2 1/8	2 1/8	2 1/8	3 3/8	5/8	1 1/4	1 1/4	.332	1.045	11.08	9.08
42	D50SK42	SK	8.720	8.363	C	2 1/8	2 1/8	2 1/8	3 3/8	5/8	1 1/4	1 1/4	.332	1.045	15.16	13.16
48	D50SK48	SK	9.910	9.556	C	2 1/8	2 1/8	2 1/8	3 3/8	5/8	1 1/4	1 1/4	.332	1.045	19.90	17.90
52	D50SF52	SF	10.710	10.351	C	2 1/16	2 1/4	2 1/4	4 1/8	3/4	1 1/4	1 1/4	.332	1.045	24.26	21.26
54	D50SF54	SF	11.110	10.749	C										26.18	23.18
60	D50SF60	SF	12.300	11.942	C										32.12	29.12
68	D50SF68	SF	13.890	13.533	C										41.16	38.16
72	D50SF72	SF	14.690	14.329	C										46.28	43.26
76	D50SF76	SF	15.490	15.124	C										47.00	44.00
84	D50SF84	SF	17.080	16.715	C										48.89	45.88
95	D50SF95	SF	19.270	18.903	C										61.80	58.88
102	D50SF102	SF	20.660	20.295	C										69.02	66.02
112	D50SF112	SF	22.650	22.285	C	2 1/16	2 1/4	2 1/4	4 1/8	3/4	1 1/4	1 1/4	.332	1.045	88.26	85.26

SPROCKETS

No. 50-2

5/8" Pitch

All Steel Stock Sprockets

Martin

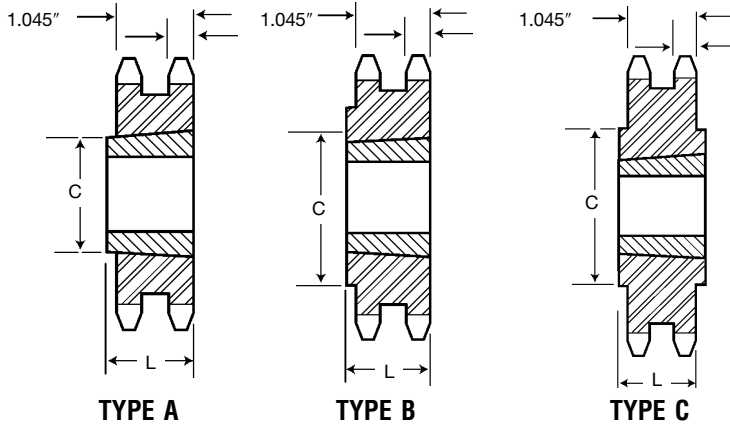

SPROCKETS

Double-Taper Bushed

No. Teeth	Catalog Number	Bushing	Diameter		Max. Bore	Dimensions		Type	Weight (Approx.)	
			Outside Diameter	Pitch Diameter		L	C		Rim Only	Bushing Only
14	D50ATB14H	1008	3.113	2.809	1	7/8		A	.8	.3
15	D50ATB15H	1210	3.315	3.006	1 1/4	1		A	.9	.6
16	D50ATB16H	1210	3.517	3.204	1 1/4	1		A	1.1	.6
17	D50ATB17H	1610	3.719	3.410	1 1/2	1		A	1.1	.6
18	D50ATB18H	1610	3.920	3.599	1 1/2	1		A	1.3	.9
19	D50ATB19H	1610	4.120	3.797	1 1/2	1		A	1.6	.9
20	D50BTB20H	2012	4.321	3.995	2	1 1/4	3/4	B	1.5	1.7
21	D50BTB21H	2012	4.522	4.193	2	1 1/4	3/4	B	1.9	1.7
25	D50BTB25H	2012	5.322	4.987	2	1 1/4	4 1/2	B	3.8	1.7
30	D50BTB30	2517	6.321	5.979	2 1/2	1 1/4	5 1/2	B	7.5	3.5
36	D50CTB36	2517	7.519	7.171	2 1/2	1 1/4	4 1/4	C	9.4	3.5
42	D50CTB42	2517	8.715	8.363	2 1/2	1 1/4	4 1/4	C	13.4	3.5
48	D50CTB48	2517	9.911	9.556	2 1/2	1 1/4	4 1/4	C	18.6	3.5
52	D50CTB52	2517	10.707	10.351	2 1/2	1 1/4	4 1/4	C	22.2	3.5
60	D50CTB60	2517	12.301	11.942	2 1/2	1 1/4	4 1/4	C	30.3	3.5
68	D50CTB68	2517	13.893	13.533	2 1/2	1 1/4	4 1/4	C	39.4	3.5
76	D50CTB76	2517	15.486	15.124	2 1/2	1 1/4	4 1/4	C	41.2	3.5
84	D50CTB84	2517	17.079	16.715	2 1/2	1 1/4	4 1/4	C	45.3	3.5
95	D50CTB95	2517	19.267	18.903	2 1/2	1 1/4	4 1/4	C	58.8	3.5
102	D50CTB102	2517	20.661	20.295	2 1/2	1 1/4	4 1/4	C	67.1	3.5

NOTE: Double 50 stock sprockets with 25 teeth or less have hardened teeth. As indicated by H suffix.

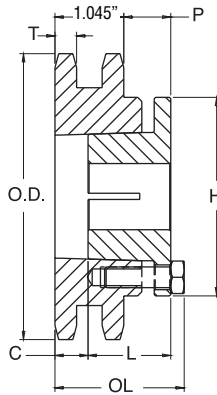
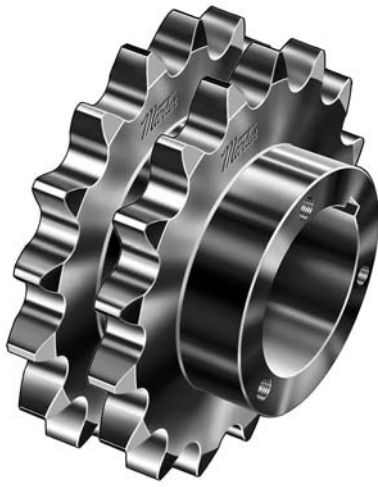

TYPE 11

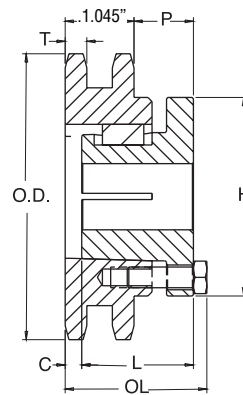

TYPE 12

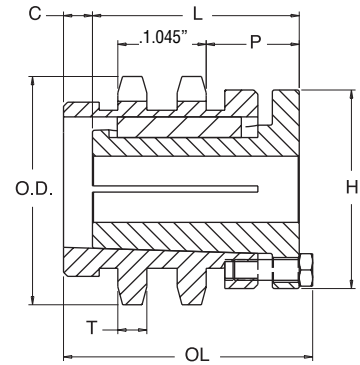

TYPE 16

Double - MST[®] Sprockets

No. Teeth	Catalog Number	Bush-ing	Diameters		Type	Max. Bore	Dimensions						Weight (Approx.)	
			Outside Dia.	Pitch Dia.			OL	L	C	H	P	T(nom)	With Hub	Rim Only
14	D50H14H	H	3.110	2.809	11	1-1/2	2 5/16	1-1/4	7/8	2-1/2	1-3/32	.332	2.0	1.2
15	D50P15H	P1	3.320	3.006	16	1-3/4	3 7/16	1-15/16	1-1/4	3	1-13/32	.332	3.3	2.0
16	D50P16H	P1	3.520	3.204	12	1-3/4	2-11/16	1-15/16	1/2	3	1-13/32	.332	2.9	1.6
17	D50P17H	P1	3.720	3.401	12	1-3/4	2-11/16	1-15/16	1/2	3	1-13/32	.332	3.4	2.1
18	D50P18H	P1	3.920	3.599	12	1-3/4	2-11/16	1-15/16	1/2	3	1-13/32	.332	3.8	2.5
19	D50P19H	P1	4.120	3.797	12	1-3/4	2-3/16	1-15/16	0	3	29/32	.332	3.3	2.0
20	D50P20H	P1	4.320	3.995	12	1-3/4	2-3/16	1-15/16	0	3	29/32	.332	3.8	2.5
21	D50P21H	P1	4.520	4.194	12	1-3/4	2-3/16	1-15/16	0	3	29/32	.332	4.1	2.8
22	D50P22H	P1	4.720	4.392	12	1-3/4	2-3/16	1-15/16	0	3	29/32	.332	4.5	3.2
23	D50P23H	P1	4.920	4.590	12	1-3/4	2-3/16	1-15/16	0	3	29/32	.332	4.9	3.6
24	D50Q24H	Q1	5.120	4.788	12	2-11/16	2-25/32	2-1/2	0	4-1/8	1-15/32	.332	7.5	4.0
25	D50Q25H	Q1	5.320	4.987	12	2-11/16	2-25/32	2-1/2	0	4-1/8	1-15/32	.332	8.0	4.5
26	D50Q26H	Q1	5.520	5.185	12	2-11/16	2-25/32	2-1/2	0	4-1/8	1-15/32	.332	8.8	5.3
27	D50Q27H	Q1	5.720	5.384	12	2-11/16	2-25/32	2-1/2	0	4-1/8	1-15/32	.332	9.4	5.9
28	D50Q28H	Q1	5.920	5.582	12	2-11/16	2-25/32	2-1/2	0	4-1/8	1-15/32	.332	9.8	6.3
30	D50Q30H	Q1	6.320	5.979	12	2-11/16	2-25/32	2-1/2	0	4-1/8	1-15/32	.332	11.0	7.5
32	D50Q32H	Q1	6.720	6.376	12	2-11/16	2-25/32	2-1/2	0	4-1/8	1-15/32	.332	12.0	8.5
35	D50Q35H	Q1	7.320	6.972	12	2-11/16	2-25/32	2-1/2	0	4-1/8	1-15/32	.332	13.9	10.4
36	D50Q36H	Q1	7.520	7.171	12	2-11/16	2-25/32	2-1/2	0	4-1/8	1-15/32	.332	14.5	11.0
40	D50Q40H	Q1	8.320	7.966	12	2-11/16	2-25/32	2-1/2	0	4-1/8	1-15/32	.332	17.1	13.6
42	D50Q42H	Q1	8.720	8.363	12	2-11/16	2-25/32	2-1/2	0	4-1/8	1-15/32	.332	18.5	15.0
45	D50Q45H	Q1	9.310	8.960	12	2-11/16	2-25/32	2-1/2	0	4-1/8	1-15/32	.332	21.0	17.5
48	D50Q48H	Q1	9.910	9.556	12	2-11/16	2-25/32	2-1/2	0	4-1/8	1-15/32	.332	23.9	20.4
52	D50Q52	Q1	10.710	10.351	12	2-11/16	2-25/32	2-1/2	0	4-1/8	1-15/32	.332	26.8	23.3
54	D50Q54	Q1	11.110	10.749	12	2-11/16	2-25/32	2-1/2	0	4-1/8	1-15/32	.332	26.8	23.3
60	D50Q60	Q1	12.300	11.942	12	2-11/16	2-25/32	2-1/2	0	4-1/8	1-15/32	.332	29.0	25.5
72	D50Q72	Q1	14.690	14.329	12	2-11/16	2-25/32	2-1/2	0	4-1/8	1-15/32	.332	46.6	43.1
76	D50Q76	Q1	15.490	15.124	12	2-11/16	2-25/32	2-1/2	0	4-1/8	1-15/32	.332	49.5	46.0
84	D50Q84	Q1	17.080	16.715	12	2-11/16	2-25/32	2-1/2	0	4-1/8	1-15/32	.332	60.2	56.7
95	D50R95	R1	19.270	18.903	12	3-3/4	3-5/32	2-7/8	0	5-3/8	2-3/32	.332	79.8	72.3
96	D50R96	R1	19.470	19.102	12	3-3/4	3-5/32	2-7/8	0	5-3/8	2-3/32	.332	88.2	80.7
102	D50R102	R1	20.660	20.295	12	3-3/4	3-5/32	2-7/8	0	5-3/8	2-3/32	.332	92.0	84.5
112	D50R112	R1	22.650	22.285	12	3-3/4	3-5/32	2-7/8	0	5-3/8	2-3/32	.332	100.7	93.2

Sprockets with "H" suffix have hardened teeth.

No. 50-3

5/8" Pitch

All Steel Stock Sprockets

Martin

Triple-Type B & C

No. Teeth	Catalog Number	Outside Diameter	Type	Bore (inches)		Hub (inches)		Weight Lbs. (Approx.)
				Stock	Rec. Max.	Dia.	Length Thru	
11	E50B11H	2.500	B	3/8	1/2	1 1/2	2 1/2	1.42
12	E50B12H	2.710	B	3/8	1/2	1 1/2	2 1/2	1.84
13	E50B13H	2.910	B	3/8	1/2	1 1/2	2 1/2	2.28
14	E50B14H	3.110	B	3/8	1/2	1 1/2	2 1/2	2.72
15	E50B15H	3.320	B	3/8	1/2	2 1/2	2 1/2	3.24
16	E50B16H	3.520	B	3/8	1/2	2 1/2	2 1/2	3.76
17	E50B17H	3.720	B	3/8	1/2	2 1/2	2 1/2	4.38
18	E50B18H	3.920	B	3/8	1/2	2 1/2	2 1/2	5.10
19	E50B19H	4.120	B	1	2 1/2	3 1/2	2 1/2	5.60
20	E50B20H	4.320	B	1	2 1/2	3 1/2	2 1/2	6.42
21	E50B21H	4.520	B	1	2 1/2	3 1/2	2 1/2	7.42
22	E50B22H	4.720	B	1	2 1/2	3 1/2	2 1/2	7.92
23	E50B23H	4.920	B	1	2 1/2	3 1/2	2 1/2	8.80
24	E50B24H	5.120	B	1	2 1/2	3 1/2	2 1/2	9.42
25	E50B25H	5.320	B	1	2 1/2	3 1/2	2 1/2	10.16
26	E50B26	5.520	B	1	2 1/2	3 1/2	2 1/2	11.02
30	E50B30	6.320	B	1	2 1/2	3 1/2	2 1/2	14.24
35	E50B35	7.320	B	1	2 1/2	3 1/2	2 1/2	18.96
36	E50B36	7.520	B	1 1/8	2 1/2	4	2 1/2	20.60
42	E50B42	8.720	B	1 1/8	2 1/2	4	2 1/2	27.46
48	E50B48	9.910	B	1 1/8	2 1/2	4	3 1/2	36.64
52	E50B52	10.710	B	1 1/8	2 1/2	4	3 1/2	42.54
60	E50B60	12.300	B	1 1/8	3	4 1/2	3 1/2	56.84
68	E50B68	13.890	B	1 1/8	3	4 1/2	3 1/2	73.21
72	E50C72	14.690	C	1 1/8	3	4 1/2	3 1/2	54.40
76	E50C76	15.490	C	1 1/8	3	4 1/2	3 1/2	51.20
84	E50C84	17.080	C	1 1/8	3	4 1/2	3 1/2	65.32
95	E50C95	19.270	C	1 1/8	3	4 1/2	3 1/2	74.42
102	E50C102	20.660	C	1 1/8	3	4 1/2	3 1/2	79.94

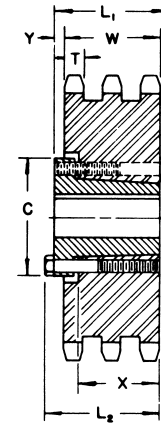
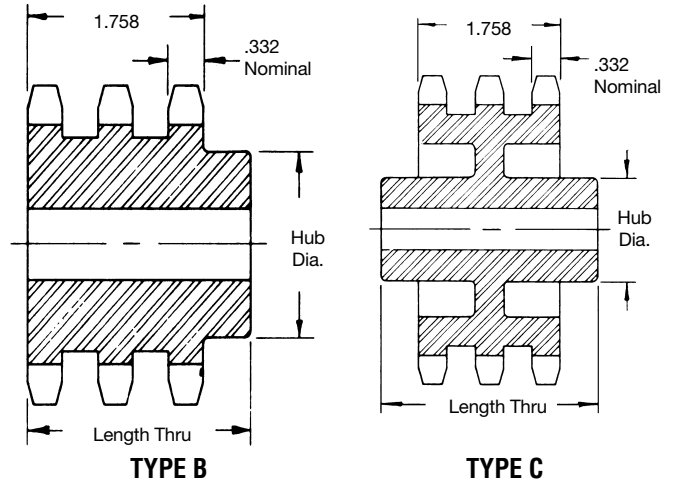

QD — TYPE B

NOTE: Triple 50 stock sprockets with 25 teeth or less have hardened teeth.

Maximum bores shown will accommodate standard keyseat and setscrew over keyseat. Slightly larger bores are possible with no keyseat, shallow keyseat, or setscrew at angle to keyseat.

NOTE: Triple 50 stock sprockets with 25 teeth or less have Hardened Teeth. As indicated by H suffix.

Alteration Charges

See current discount sheet for alteration charges.

Triple-Type QD

No. Teeth	Catalog Number	Bushing	Diameters		Type	Max. Bore	Dimensions								Weight (Approx.)	
			Outside Diameter	Pitch Diameter			L ₁	L ₂	C	Y	V	X	T	W	With Hub	Rim Only
36	E50SK36	SK	7.520	7.171	B	2 1/2	2 1/2	2 1/2	3 1/2	1/2		1 1/4	.332	1.758	14.8	12.8
42	E50SK42	SK	8.720	8.363	B	2 1/2	2 1/2	2 1/2	3 1/2	1/2		1 1/4	.332	1.758	21.5	19.5
48	E50SK48	SK	9.910	9.556	B	2 1/2	2 1/2	2 1/2	3 1/2	1/2		1 1/4	.332	1.758	29.6	27.6
52	E50SF52	SF	10.710	10.351	B	2 1/2	2 1/2	2 1/2	4 1/2	1/2		1 1/4	.332	1.758	31.6	28.6
60	E50SF60	SF	12.300	11.942	B										42.1	39.1
68	E50SF68	SF	13.890	13.533	B										53.8	50.8
72	E50SF72	SF	14.690	14.329	B										46.6	43.6
76	E50SF76	SF	15.490	15.124	B						1/2				49.9	46.9
84	E50SF84	SF	17.080	16.715	B										53.9	50.9
95	E50SF95	SF	19.270	18.903	B										62.3	59.3
102	E50SF102	SF	20.660	20.295	B	2 1/2	2 1/2	2 1/2	4 1/2	1/2		1 1/4	.332	1.758	69.3	66.3

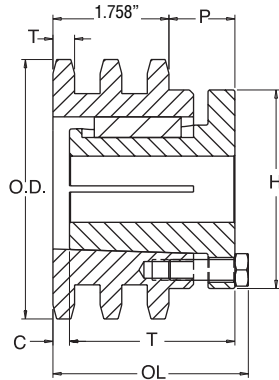

TYPE 22

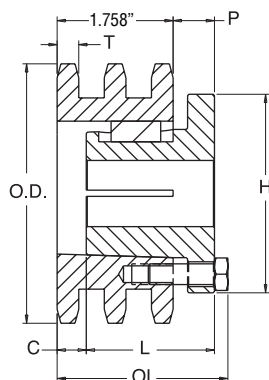

TYPE 23

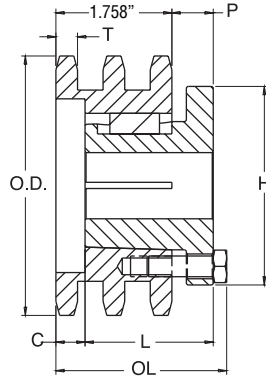

TYPE 24

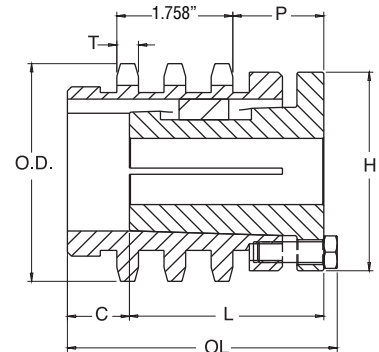

TYPE 27

Triple - MST[®] Sprockets

No. Teeth	Catalog Number	Bush-ing	Diameters		Type	Max. Bore	Dimensions						Weight (Approx.)	
			Outside Dia.	Pitch Dia.			OL	L	C	H	P	T(nom)	With Hub	Rim Only
15	E50P15H	P2	3.320	3.006	27	1-3/4	4-1/8	2-15/16	15/16	3	1-3/8	.332	4.0	2.5
16	E50P16H	P2	3.520	3.204	22	1-3/4	3 3/8	2-15/16	3/16	3	1-3/8	.332	3.9	2.4
17	E50P17H	P2	3.720	3.401	22	1-3/4	3 3/8	2-15/16	3/16	3	1-3/8	.332	4.3	2.8
18	E50P18H	P2	3.920	3.599	22	1-3/4	3 3/8	2-15/16	3/16	3	1-3/8	.332	4.9	3.4
19	E50P19H	P1	4.120	3.797	24	1-3/4	2-5/8	1-15/16	7/16	3	5/8	.332	4.2	2.9
20	E50P20H	P1	4.320	3.995	24	1-3/4	2-5/8	1-15/16	7/16	3	5/8	.332	4.4	3.1
21	E50P21H	P1	4.520	4.194	24	1-3/4	2-5/8	1-15/16	7/16	3	5/8	.332	4.8	3.5
23	E50P23H	P1	4.920	4.590	24	1-3/4	2-5/8	1-15/16	7/16	3	5/8	.332	5.8	4.5
24	E50Q24H	Q1	5.120	4.788	23	2-11/16	2-25/32	2-1/2	0	4-1/8	3/4	.332	8.2	4.7
25	E50Q25H	Q1	5.320	4.987	23	2-11/16	2-25/32	2-1/2	0	4-1/8	3/4	.332	8.5	5.0
26	E50Q26H	Q1	5.520	5.185	23	2-11/16	2-25/32	2-1/2	0	4-1/8	3/4	.332	9.4	5.9
28	E50Q28H	Q1	5.920	5.582	23	2-11/16	2-25/32	2-1/2	0	4-1/8	3/4	.332	10.8	7.3
30	E50Q30H	Q1	6.320	5.979	23	2-11/16	2-25/32	2-1/2	0	4-1/8	3/4	.332	12.3	8.8
32	E50Q32H	Q1	6.720	6.376	23	2-11/16	2-25/32	2-1/2	0	4-1/8	3/4	.332	14.4	10.9
35	E50Q35H	Q1	7.320	6.972	23	2-11/16	2-25/32	2-1/2	0	4-1/8	3/4	.332	17.2	13.7
36	E50Q36H	Q1	7.520	7.171	23	2-11/16	2-25/32	2-1/2	0	4-1/8	3/4	.332	18.1	14.6
40	E50Q40H	Q1	8.320	7.966	23	2-11/16	2-25/32	2-1/2	0	4-1/8	3/4	.332	22.6	19.1
42	E50Q42H	Q1	8.720	8.363	23	2-11/16	2-25/32	2-1/2	0	4-1/8	3/4	.332	25.0	21.5
48	E50Q48H	Q1	9.910	9.556	23	2-11/16	2-25/32	2-1/2	0	4-1/8	3/4	.332	33.1	29.6
52	E50Q52	Q1	10.710	10.351	23	2-11/16	2-25/32	2-1/2	0	4-1/8	3/4	.332	39.9	36.4
60	E50R60	R1	12.300	11.942	22	3-3/4	2-5/32	2-7/8	0	5-3/8	1-1/8	.332	55.5	48.0
68	E50R68	R1	13.890	13.533	22	3-3/4	2-5/32	2-7/8	0	5-3/8	1-1/8	.332	71.0	63.5
72	E50R72	R1	14.690	14.329	22	3-3/4	2-5/32	2-7/8	0	5-3/8	1-1/8	.332	79.5	72.0
76	E50R76	R1	15.490	15.124	22	3-3/4	2-5/32	2-7/8	0	5-3/8	1-1/8	.332	88.5	81.0
84	E50R84	R1	17.080	16.715	22	3-3/4	2-5/32	2-7/8	0	5-3/8	1-1/8	.332	107.5	100.0
95	E50R95	R1	19.270	18.903	22	3-3/4	2-5/32	2-7/8	0	5-3/8	1-1/8	.332	137.5	130.0
102	E50R102	R1	20.660	20.295	22	3-3/4	2-5/32	2-7/8	0	5-3/8	1-1/8	.332	158.5	151.0

Sprockets with "H" suffix have hardened teeth.

No. 60

3/4" Pitch

All Steel Stock Sprockets

Martin

Single Type "BS"— 2 Setscrews — Bored-To-Size

No. Teeth	Catalog Number	Outside Diameter	Length Thru Bore	Weight Lbs. (Approx.)	Stock Finished Bores Includes Keyway and Setscrews
9	60BS9	2.510	1 1/4	.6	3/4 - 7/8 - 1
10	60BS10	2.760	1 1/4	.7	3/4 - 7/8 - 1 - 1 1/8 - 1 1/4 - 1 1/2 - 1 3/4
11	60BS11	3.000	1 1/4	.9	3/4 - 7/8 - 1 - 1 1/8 - 1 1/4 - 1 1/2 - 1 3/4
11	60BS11W*	3.000	1 1/4	.8	1 1/4
12	60BS12	3.250	1 1/4	1.3	3/4 - 7/8 - 1 - 1 1/8 - 1 1/4 - 1 1/2 - 1 3/4 - 1 1/2 - 1 3/4
12	60BS12W*	3.250	1 1/4	1.1	1 1/4
13	60BS13	3.490	1 1/4	1.3	3/4 - 7/8 - 1 - 1 1/8 - 1 1/4 - 1 1/2 - 1 3/4 - 1 1/2 - 1 3/4
14	60BS14	3.740	1 1/4	1.6	3/4 - 7/8 - 1 - 1 1/8 - 1 1/4 - 1 1/2 - 1 3/4 - 1 1/2 - 1 3/4
15	60BS15	3.980	1 1/4	1.7	3/4 - 7/8 - 1 - 1 1/8 - 1 1/4 - 1 1/2 - 1 3/4 - 1 1/2 - 1 3/4 - 1 1/2 - 1 3/4
16	60BS16	4.220	1 1/4	2.1	3/4 - 7/8 - 1 - 1 1/8 - 1 1/4 - 1 1/2 - 1 3/4 - 1 1/2 - 1 3/4 - 1 1/2 - 1 3/4 - 1 1/2 - 1 3/4
17	60BS17	4.460	1 1/4	2.4	1 - 1 1/8 - 1 1/4 - 1 1/2 - 1 3/4 - 1 1/2 - 1 3/4 - 1 1/2 - 1 3/4 - 1 1/2 - 1 3/4
18	60BS18	4.700	1 1/4	2.6	1 - 1 1/8 - 1 1/4 - 1 1/2 - 1 3/4 - 1 1/2 - 1 3/4 - 1 1/2 - 1 3/4 - 1 1/2 - 1 3/4
18	60BS18W*	4.700	1 1/4	2.6	1 1/4
19	60BS19	4.950	1 1/4	3.4	1 - 1 1/8 - 1 1/4 - 1 1/2 - 1 3/4 - 1 1/2 - 1 3/4 - 1 1/2 - 1 3/4 - 1 1/2 - 1 3/4
20	60BS20	5.190	1 1/4	3.9	1 - 1 1/8 - 1 1/4 - 1 1/2 - 1 3/4 - 1 1/2 - 1 3/4 - 1 1/2 - 1 3/4 - 1 1/2 - 1 3/4
21	60BS21	5.430	1 1/4	4.4	1 - 1 1/8 - 1 1/4 - 1 1/2 - 1 3/4 - 1 1/2 - 1 3/4 - 1 1/2 - 1 3/4 - 1 1/2 - 1 3/4
22	60BS22	5.670	1 1/4	4.7	1 - 1 1/8 - 1 1/4 - 1 1/2 - 1 3/4 - 1 1/2 - 1 3/4 - 1 1/2 - 1 3/4 - 1 1/2 - 1 3/4
23	60BS23	5.910	1 1/4	5.0	1 - 1 1/8 - 1 1/4 - 1 1/2 - 1 3/4 - 1 1/2 - 1 3/4 - 1 1/2 - 1 3/4 - 1 1/2 - 1 3/4
24	60BS24	6.150	1 1/4	5.3	1 - 1 1/8 - 1 1/4 - 1 1/2 - 1 3/4 - 1 1/2 - 1 3/4 - 1 1/2 - 1 3/4 - 1 1/2 - 1 3/4
25	60BS25	6.390	1 1/4	5.4	1 - 1 1/8 - 1 1/4 - 1 1/2 - 1 3/4 - 1 1/2 - 1 3/4 - 1 1/2 - 1 3/4 - 1 1/2 - 1 3/4
26	60BS26	6.630	1 1/4	5.8	1 - 1 1/8 - 1 1/4 - 1 1/2 - 1 3/4 - 1 1/2 - 1 3/4 - 1 1/2 - 1 3/4 - 1 1/2 - 1 3/4
27	60BS27	6.870	1 1/4	6.3	1 - 1 1/8 - 1 1/4 - 1 1/2 - 1 3/4 - 1 1/2 - 1 3/4 - 1 1/2 - 1 3/4 - 1 1/2 - 1 3/4
28	60BS28	7.110	1 1/4	6.4	1 - 1 1/8 - 1 1/4 - 1 1/2 - 1 3/4 - 1 1/2 - 1 3/4 - 1 1/2 - 1 3/4 - 1 1/2 - 1 3/4
29	60BS29	7.350	1 1/4	6.9	1 - 1 1/8 - 1 1/4 - 1 1/2 - 1 3/4 - 1 1/2 - 1 3/4 - 1 1/2 - 1 3/4 - 1 1/2 - 1 3/4
30	60BS30	7.590	1 1/4	7.1	1 - 1 1/8 - 1 1/4 - 1 1/2 - 1 3/4 - 1 1/2 - 1 3/4 - 1 1/2 - 1 3/4 - 1 1/2 - 1 3/4
31	60BS31	7.830	1 1/4	7.4	1 - 1 1/8 - 1 1/4 - 1 1/2 - 1 3/4 - 1 1/2 - 1 3/4 - 1 1/2 - 1 3/4 - 1 1/2 - 1 3/4
32	60BS32	8.070	1 1/4	7.8	1 - 1 1/8 - 1 1/4 - 1 1/2 - 1 3/4 - 1 1/2 - 1 3/4 - 1 1/2 - 1 3/4 - 1 1/2 - 1 3/4
33	60BS33	8.300	1 1/4	8.2	1 - 1 1/8 - 1 1/4 - 1 1/2 - 1 3/4 - 1 1/2 - 1 3/4 - 1 1/2 - 1 3/4 - 1 1/2 - 1 3/4
34	60BS34	8.540	1 1/4	8.5	1 - 1 1/8 - 1 1/4 - 1 1/2 - 1 3/4 - 1 1/2 - 1 3/4 - 1 1/2 - 1 3/4 - 1 1/2 - 1 3/4
35	60BS35	8.780	1 1/4	8.8	1 - 1 1/8 - 1 1/4 - 1 1/2 - 1 3/4 - 1 1/2 - 1 3/4 - 1 1/2 - 1 3/4 - 1 1/2 - 1 3/4
36	60BS36	9.020	1 1/4	9.2	1 - 1 1/8 - 1 1/4 - 1 1/2 - 1 3/4 - 1 1/2 - 1 3/4 - 1 1/2 - 1 3/4 - 1 1/2 - 1 3/4 - 1 1/2 - 1 3/4
37	60BS37	9.260	1 1/4	9.9	1 - 1 1/8 - 1 1/4 - 1 1/2 - 1 3/4 - 1 1/2 - 1 3/4 - 1 1/2 - 1 3/4 - 1 1/2 - 1 3/4 - 1 1/2 - 1 3/4
38	60BS38	9.500	1 1/4	10.5	1 - 1 1/8 - 1 1/4 - 1 1/2 - 1 3/4 - 1 1/2 - 1 3/4 - 1 1/2 - 1 3/4 - 1 1/2 - 1 3/4 - 1 1/2 - 1 3/4
39	60BS39	9.740	1 1/4	10.9	1 - 1 1/8 - 1 1/4 - 1 1/2 - 1 3/4 - 1 1/2 - 1 3/4 - 1 1/2 - 1 3/4 - 1 1/2 - 1 3/4 - 1 1/2 - 1 3/4
40	60BS40	9.980	1 1/4	11.2	1 - 1 1/8 - 1 1/4 - 1 1/2 - 1 3/4 - 1 1/2 - 1 3/4 - 1 1/2 - 1 3/4 - 1 1/2 - 1 3/4 - 1 1/2 - 1 3/4
41	60BS41	10.220	1 1/4	11.8	1 - 1 1/8 - 1 1/4 - 1 1/2 - 1 3/4 - 1 1/2 - 1 3/4 - 1 1/2 - 1 3/4 - 1 1/2 - 1 3/4 - 1 1/2 - 1 3/4
42	60BS42	10.460	1 1/4	12.4	1 - 1 1/8 - 1 1/4 - 1 1/2 - 1 3/4 - 1 1/2 - 1 3/4 - 1 1/2 - 1 3/4 - 1 1/2 - 1 3/4 - 1 1/2 - 1 3/4
43	60BS43	10.700	1 1/4	13.0	1 - 1 1/8 - 1 1/4 - 1 1/2 - 1 3/4 - 1 1/2 - 1 3/4 - 1 1/2 - 1 3/4 - 1 1/2 - 1 3/4 - 1 1/2 - 1 3/4
44	60BS44	10.940	1 1/4	13.5	1 - 1 1/8 - 1 1/4 - 1 1/2 - 1 3/4 - 1 1/2 - 1 3/4 - 1 1/2 - 1 3/4 - 1 1/2 - 1 3/4 - 1 1/2 - 1 3/4
45	60BS45	11.180	1 1/4	13.8	1 - 1 1/8 - 1 1/4 - 1 1/2 - 1 3/4 - 1 1/2 - 1 3/4 - 1 1/2 - 1 3/4 - 1 1/2 - 1 3/4 - 1 1/2 - 1 3/4
46	60BS46	11.420	1 1/4	14.1	1 - 1 1/8 - 1 1/4 - 1 1/2 - 1 3/4 - 1 1/2 - 1 3/4 - 1 1/2 - 1 3/4 - 1 1/2 - 1 3/4 - 1 1/2 - 1 3/4
47	60BS47	11.650	1 1/4	14.6	1 - 1 1/8 - 1 1/4 - 1 1/2 - 1 3/4 - 1 1/2 - 1 3/4 - 1 1/2 - 1 3/4 - 1 1/2 - 1 3/4 - 1 1/2 - 1 3/4
48	60BS48	11.890	1 1/4	15.4	1 - 1 1/8 - 1 1/4 - 1 1/2 - 1 3/4 - 1 1/2 - 1 3/4 - 1 1/2 - 1 3/4 - 1 1/2 - 1 3/4 - 1 1/2 - 1 3/4
49	60BS49	12.130	1 1/4	16.4	1 - 1 1/8 - 1 1/4 - 1 1/2 - 1 3/4 - 1 1/2 - 1 3/4 - 1 1/2 - 1 3/4 - 1 1/2 - 1 3/4 - 1 1/2 - 1 3/4
50	60BS50	12.370	1 1/4	17.3	1 - 1 1/8 - 1 1/4 - 1 1/2 - 1 3/4 - 1 1/2 - 1 3/4 - 1 1/2 - 1 3/4 - 1 1/2 - 1 3/4 - 1 1/2 - 1 3/4
51	60BS51	12.610	1 1/4	18.3	1 - 1 1/8 - 1 1/4 - 1 1/2 - 1 3/4 - 1 1/2 - 1 3/4 - 1 1/2 - 1 3/4 - 1 1/2 - 1 3/4 - 1 1/2 - 1 3/4
52	60BS52	12.850	1 1/4	19.3	1 - 1 1/8 - 1 1/4 - 1 1/2 - 1 3/4 - 1 1/2 - 1 3/4 - 1 1/2 - 1 3/4 - 1 1/2 - 1 3/4 - 1 1/2 - 1 3/4
53	60BS53	13.090	1 1/4	20.3	1 - 1 1/8 - 1 1/4 - 1 1/2 - 1 3/4 - 1 1/2 - 1 3/4 - 1 1/2 - 1 3/4 - 1 1/2 - 1 3/4 - 1 1/2 - 1 3/4
54	60BS54	13.330	1 1/4	21.0	1 - 1 1/8 - 1 1/4 - 1 1/2 - 1 3/4 - 1 1/2 - 1 3/4 - 1 1/2 - 1 3/4 - 1 1/2 - 1 3/4 - 1 1/2 - 1 3/4
55	60BS55	13.570	1 1/4	21.2	1 - 1 1/8 - 1 1/4 - 1 1/2 - 1 3/4 - 1 1/2 - 1 3/4 - 1 1/2 - 1 3/4 - 1 1/2 - 1 3/4 - 1 1/2 - 1 3/4
56	60BS56	13.810	1 1/4	21.3	1 - 1 1/8 - 1 1/4 - 1 1/2 - 1 3/4 - 1 1/2 - 1 3/4 - 1 1/2 - 1 3/4 - 1 1/2 - 1 3/4 - 1 1/2 - 1 3/4
57	60BS57	14.040	1 1/4	22.2	1 - 1 1/8 - 1 1/4 - 1 1/2 - 1 3/4 - 1 1/2 - 1 3/4 - 1 1/2 - 1 3/4 - 1 1/2 - 1 3/4 - 1 1/2 - 1 3/4
58	60BS58	14.280	1 1/4	23.0	1 - 1 1/8 - 1 1/4 - 1 1/2 - 1 3/4 - 1 1/2 - 1 3/4 - 1 1/2 - 1 3/4 - 1 1/2 - 1 3/4 - 1 1/2 - 1 3/4
59	60BS59	14.520	1 1/4	23.8	1 - 1 1/8 - 1 1/4 - 1 1/2 - 1 3/4 - 1 1/2 - 1 3/4 - 1 1/2 - 1 3/4 - 1 1/2 - 1 3/4 - 1 1/2 - 1 3/4
60	60BS60	14.760	1 1/4	25.0	1 - 1 1/8 - 1 1/4 - 1 1/2 - 1 3/4 - 1 1/2 - 1 3/4 - 1 1/2 - 1 3/4 - 1 1/2 - 1 3/4 - 1 1/2 - 1 3/4
70	60BS70	17.150	1 1/4	31.4	1 - 1 1/8 - 1 1/4 - 1 1/2 - 1 3/4 - 1 1/2 - 1 3/4 - 1 1/2 - 1 3/4 - 1 1/2 - 1 3/4 - 1 1/2 - 1 3/4
72	60BS72	17.630	2	33.5	1 - 1 1/8 - 1 1/4 - 1 1/2 - 1 3/4 - 1 1/2 - 1 3/4 - 1 1/2 - 1 3/4 - 1 1/2 - 1 3/4 - 1 1/2 - 1 3/4
80	60BS80	19.540	2	41.2	1 - 1 1/8 - 1 1/4 - 1 1/2 - 1 3/4 - 1 1/2 - 1 3/4 - 1 1/2 - 1 3/4 - 1 1/2 - 1 3/4 - 1 1/2 - 1 3/4
84	60BS84	20.490	2	45.8	1 - 1 1/8 - 1 1/4 - 1 1/2 - 1 3/4 - 1 1/2 - 1 3/4 - 1 1/2 - 1 3/4 - 1 1/2 - 1 3/4 - 1 1/2 - 1 3/4
96	60BS96	23.360	2 1/2	62.3	1 - 1 1/8 - 1 1/4 - 1 1/2 - 1 3/4 - 1 1/2 - 1 3/4 - 1 1/2 - 1 3/4 - 1 1/2 - 1 3/4 - 1 1/2 - 1 3/4
112	60BS112	27.180	2 1/2	81.0	1 - 1 1/8 - 1 1/4 - 1 1/2 - 1 3/4 - 1 1/2 - 1 3/4 - 1 1/2 - 1 3/4 - 1 1/2 - 1 3/4 - 1 1/2 - 1 3/4

Hub diameters vary to suit different bore sizes.

* W = Winch Sprockets — KW 3/16 x 5/32 — One SS at 90°

KEYWAY IS ON CENTER LINE OF TOOTH.

SPROCKETS

Martin

All Steel Stock Sprockets

No. 60 3/4" Pitch

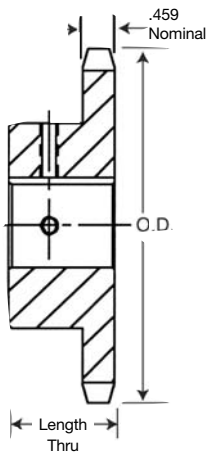

TYPE BS



No. 60-Hardened Teeth — 2 Setscrews

No. Teeth	Catalog Number	Outside Diameter	Length Thru Bore	Weight Lbs. (Approx.)	Stock Finished Bores Includes Keyway and Setscrews
9	60BS9HT	2.51	1 1/4	.6	3/4 - 7/8 - 1
10	60BS10HT	2.76	1 1/4	.7	3/4 - 7/8 - 1 - 1 1/8 - 1 1/4 - 1 1/2
11	60BS11HT	3.00	1 1/4	.9	3/4 - 7/8 - 1 - 1 1/8 - 1 1/4 - 1 1/2
12	60BS12HT	3.25	1 1/4	1.3	3/4 - 7/8 - 1 - 1 1/8 - 1 1/4 - 1 1/2 - 1 3/4
13	60BS13HT	3.49	1 1/4	1.3	3/4 - 7/8 - 1 - 1 1/8 - 1 1/4 - 1 1/2 - 1 3/4 - 1 1/2
14	60BS14HT	3.74	1 1/4	1.6	3/4 - 7/8 - 1 - 1 1/8 - 1 1/4 - 1 1/2 - 1 3/4 - 1 1/2 - 1 3/4
15	60BS15HT	3.98	1 1/4	1.7	3/4 - 7/8 - 1 - 1 1/8 - 1 1/4 - 1 1/2 - 1 3/4 - 1 1/2 - 1 3/4 - 1 1/2
16	60BS16HT	4.22	1 1/4	2.1	3/4 - 7/8 - 1 - 1 1/8 - 1 1/4 - 1 1/2 - 1 3/4 - 1 1/2 - 1 3/4 - 1 1/2 - 1 3/4
17	60BS17HT	4.46	1 1/4	2.4	1 - 1 1/8 - 1 1/4 - 1 1/2 - 1 3/4 - 1 1/2 - 1 3/4 - 1 1/2 - 1 3/4 - 1 1/2
18	60BS18HT	4.70	1 1/4	2.6	1 - 1 1/8 - 1 1/4 - 1 1/2 - 1 3/4 - 1 1/2 - 1 3/4 - 1 1/2 - 1 3/4 - 1 1/2
19	60BS19HT	4.95	1 1/4	3.4	1 - 1 1/8 - 1 1/4 - 1 1/2 - 1 3/4 - 1 1/2 - 1 3/4 - 1 1/2 - 1 3/4 - 1 1/2
20	60BS20HT	5.19	1 1/4	3.9	1 - 1 1/8 - 1 1/4 - 1 1/2 - 1 3/4 - 1 1/2 - 1 3/4 - 1 1/2 - 1 3/4 - 1 1/2

KEYWAY IS ON CENTER LINE OF TOOTH.

Martin stock hardened teeth sprockets afford longer chain and sprocket life. Hardened teeth on the smaller sprocket of a roller chain drive are recommended if the drive ratio is four to one or greater or if the smaller sprocket has 24 teeth or less and is running at a speed of over 600 R.P.M.

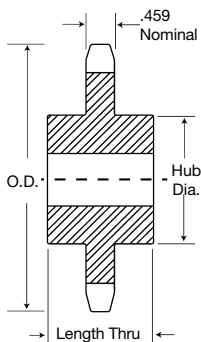

TYPE C

Single-Type C

No. Teeth	Catalog Number	Outside Diameter	Bore (inches)		Hub (inches)		Weight Lbs. (Approx.)
			Stock	Rec. Max.	Diameter	Length	
12	60C12	3.250	3/4	1 1/8	2 3/8*	2	2.25
13	60C13	3.490	3/4	1 1/2	2 1/2	2	2.75
14	60C14	3.740	3/4	1 3/4	2 9/16	2	3.19
15	60C15	3.980	3/4	1 7/8	2 7/8	2	3.10
16	60C16	4.220	3/4	2	3 1/16	2	4.19
17	60C17	4.460	3/4	2 1/4	3 3/4	2	4.81
18	60C18	4.700	3/4	2 3/4	3 1/2	2	5.62

* Has recessed groove in hub for chain clearance.

SPROCKETS

No. 60

3/4" Pitch

All Steel Stock Sprockets

Martin



SPROCKETS

Double Single-Type A — Steel

No. Teeth	Catalog Number	Diameters		Type	Min. Bore	Max. Bore	Dimensions				Wt. (Approx.)
		Outside Diameter	Pitch Diameter				L	C	E	w Nom.	
13	DS60A13	3.490	3.134	A	3/4	1 1/4	1 15/16	1 31/64	2 11/32	.459	2.6
14	DS60A14	3.740	3.371	A	3/4	1 1/2	1 15/16	1 31/64	2 3/16	.459	3.2
15	DS60A15	3.980	3.607	A	3/4	1 5/8	1 15/16	1 31/64	2 7/8	.459	3.8
16	DS60A16	4.220	3.844	A	3/4	1 3/4	1 15/16	1 31/64	3 3/64	.459	4.5
17	DS60A17	4.460	4.082	A	3/4	1 7/8	1 15/16	1 31/64	3 1/2	.459	5.3
18	DS60A18	4.700	4.319	A	3/4	1 15/8	1 15/16	1 31/64	3 7/8	.459	6.5
19	DS60A19	4.950	4.557	A	3/4	1 7/8	1 15/16	1 31/64	3 5/8	.459	6.8
20	DS60A20	5.190	4.794	A	3/4	2 1/8	1 15/16	1 31/64	3 61/64	.459	7.0
21	DS60A21	5.430	5.032	A	3/4	2 1/4	1 15/16	1 31/64	4 1/16	.459	7.5
22	DS60A22	5.670	5.270	A	3/4	2 1/2	1 15/16	1 31/64	4 1/8	.459	11.0
23	DS60A23	5.910	5.508	A	3/4	2 3/8	1 15/16	1 31/64	4 21/32	.459	11.5
24	DS60A24	6.150	5.749	A	3/4	2 1/2	1 15/16	1 31/64	4 29/32	.459	12.0

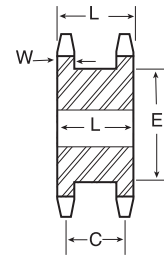

TYPE A

Double Single-Taper Bushed — Steel

No. Teeth	Catalog Number	Bushing Size	Diameters		Min. Bore	Max. Bore	Type	Dimensions				Wt. Rim Only	
			Outside Diameter	Pitch Diameter				L ₁	C	E	L ₂		w Nom.
16	DS60ATB16H	1615	4.220	3.844	1/2	1 1/8	A	1 15/16	1 31/64	2 63/64	1 1/2	.459	4.5
17	DS60ATB17H	1615	4.460	4.002	1/2	1 1/8	A	1 15/16	1 31/64	3 1/2	1 1/2	.459	4.5
18	DS60ATB18H	2012	4.700	4.319	1/2	2	A	1 15/16	1 31/64	3 15/32	1 1/4	.459	5.0
19	DS60ATB19H	2012	4.950	4.557	1/2	2	A	1 15/16	1 31/64	3 5/8	1 1/4	.459	5.8
20	DS60ATB20H	2517	5.190	4.794	1/2	2 1/8	A	1 15/16	1 31/64	3 61/64	1 1/4	.459	5.6
21	DS60ATB21H	2517	5.430	5.032	1/2	2 1/4	A	1 15/16	1 31/64	4 1/16	1 1/4	.459	6.4
23	DS60ATB23H	2517	5.910	5.508	1/2	2 3/8	A	1 15/16	1 31/64	4 3/8	1 1/4	.459	7.3
24	DS60ATB24H	2517	6.150	5.746	1/2	2 1/2	A	1 15/16	1 31/64	4 29/32	1 1/4	.459	8.2

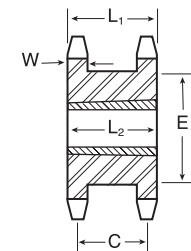

TAPER BUSH TYPE A

Double Single-MST® — Steel

No. Teeth	Catalog Number	Bushing Size	Diameters		Min. Bore	Max. Bore	Type	Dimensions				Wt. Rim Only	
			Outside Diameter	Pitch Diameter				L ₁	C	E	L ₂		w Nom.
17	DS60P17H	P1	4.460	4.002	1/2	1 1/8	B	1 15/16	1 31/64	3 1/2	1 15/16	.459	3.9
19	DS60P19H	P1	4.950	4.557	1/2	1 1/8	B	1 15/16	1 31/64	3 5/8	1 15/16	.459	5.3
21	DS60Q21H	Q1	5.430	5.032	3/4	2 15/16	B	1 15/16	1 31/64	4 3/16	2 1/2	.459	5.4
22	DS60Q22H	Q1	5.670	5.270	3/4	2 15/16	B	1 15/16	1 31/64	4 27/64	2 1/2	.459	6.2
23	DS60Q23H	Q1	5.910	5.508	3/4	2 15/16	B	1 15/16	1 31/64	4 3/8	2 1/2	.459	6.9
24	DS60Q24H	Q1	6.150	5.746	3/4	2 15/16	B	1 15/16	1 31/64	4 29/32	2 1/2	.459	7.6

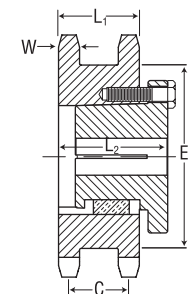

MST TYPE B

Single-Type B — Stainless

Single-Type A

No. Teeth	Catalog Number	Outside Diameter	Type	Bore (inches)		Hub (inches)		Weight Lbs. (Approx.)	Type	Catalog Number	Stock Bore	Weight Lbs. (Appl.)
				Stock	Rec. Max.	Diameter	Length Thru					
12	60B12SS	3.250	B	3/4	1 1/8	2 3/8*	1 1/4	1.5				
13	60B13SS	3.490	B	3/4	1 1/2	2 1/2	1 1/4	1.8				
14	60B14SS	3.740	B	3/4	1 3/4	2 5/8	1 1/4	2.0				
15	60B15SS	3.980	B	3/4	1 7/8	2 7/8	1 1/4	2.4				
16	60B16SS	4.220	B	3/4	2	3 1/8	1 1/4	2.8				
17	60B17SS	4.466	B	3/4	2 1/4	3 1/4	1 1/4	3.3				
18	60B18SS	4.700	B	3/4	2 3/8	3 3/8	1 1/4	3.8				
19	60B19SS	4.950	B	3/4	2 1/2	3 1/2	1 1/4	4.0				
20	60B20SS	5.190	B	3/4	2 5/8	3 5/8	1 1/4	4.6				
21	60B21SS	5.430	B	3/4	2 3/4	4	1 1/4	5.0	A	60A21SS	3/4	2.5
22	60B22SS	5.670	B	3/4	2 7/8	4	1 1/4	5.3	A	60A22SS	3/4	2.7
23	60B23SS	5.910	B	3/4	3	4	1 1/4	5.7	A	60A23SS	3/4	3.0
24	60B24SS	6.150	B	3/4	2 3/4	4	1 1/4	5.9	A	60A24SS	2 5/8	3.1
25	60B25SS	6.390	B	3/4	2 7/8	4	1 1/4	6.1	A	60A25SS	2 5/8	3.3
26	60B26SS	6.630	B	3/4	3	4	1 1/4	6.3	A	60A26SS	2 5/8	3.8
28	60B28SS	7.110	B	3/4	2 3/4	4	1 1/4	6.7	A	60A28SS	2 5/8	4.2
30	60B30SS	7.590	B	3/4	2 3/4	4	1 1/4	7.0	A	60A30SS	2 5/8	4.7
35	60B35SS	8.780	B	1	2 3/4	4	1 1/4	9.0	A	60A35SS	1 5/8	6.9
40	60B40SS	9.980	B	1	2 3/4	4 1/4	1 1/4	11.7	A	60A40SS	1 5/8	8.3
45	60B45SS	11.180	B	1	2 3/4	4 1/4	1 1/4	14.5	A	60A45SS	1 5/8	10.6
60	60B60SS	14.760	B	1 1/4	2 3/4	4 1/4	1 1/4	25.0	A	60A60SS	1 1/4	18.0

★ Has recessed groove in hub for chain clearance.

Maximum bores shown will accommodate standard keyseat and setscrew over keyseat. Slightly larger bores are possible with no keyseat, shallow keyseat, or setscrew at angle to keyseat.

Sprockets altered at factory (rebored with keyway and setscrew added) will be supplied with stainless setscrew.

SPROCKETS



STAINLESS STEEL

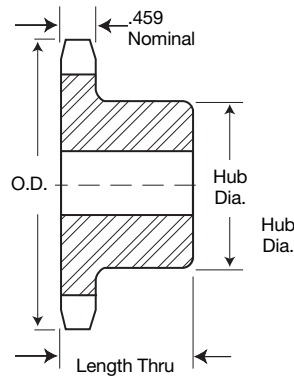

TYPE B

Alteration Charges

See current discount sheet for alteration charges.

No. 60

3/4" Pitch

All Steel Stock Sprockets

Martin

Single-Type B

Single-Type A

No. Teeth	Catalog Number	Outside Diameter	Type	Bore (inches)		Hub (inches)		Weight Lbs (Approx.)	Type	Catalog Number	Stock Bore	Weight Lbs. (Approx.)
				Stock	Rec. Max.	Diameter	Length Thru					
8	60B8	2.260	B	3/8	3/8	1 1/16*	1 1/4	.54				
9	60B9	2.510	B	3/8	7/8	1 1/16*	1 1/4	.64				
10	60B10	2.760	B	3/8	1 1/8	1 1/16*	1 1/4	.99	A	60A10	3/8	.44
11	60B11	3.000	B	3/8	1 1/8	2 1/16*	1 1/4	1.16	A	60A11	3/8	.54
12	60B12	3.250	B	3/8	1 1/8	2 1/8*	1 1/4	1.47	A	60A12	3/8	.68
13	60B13	3.490	B	3/8	1 1/8	2 1/8*	1 1/4	1.66	A	60A13	3/8	.80
14	60B14	3.740	B	3/8	1 1/8	2 1/8*	1 1/4	2.00	A	60A14	3/8	.94
15	60B15	3.980	B	3/8	1 1/8	2 1/8*	1 1/4	2.51	A	60A15	3/8	1.08
16	60B16	4.220	B	3/8	2	3 1/16	1 1/4	2.81	A	60A16	3/8	1.24
17	60B17	4.460	B	3/8	2 1/8	3 1/8	1 1/4	3.22	A	60A17	3/8	1.44
18	60B18	4.700	B	3/8	2 1/8	3 1/8	1 1/4	3.72	A	60A18	3/8	1.62
19	60B19	4.950	B	3/8	2 1/8	3 1/2	1 1/4	3.92	A	60A19	3/8	1.84
20	60B20	5.190	B	3/8	2 1/8	3 1/2	1 1/4	4.63	A	60A20	3/8	2.12
21	60B21	5.430	B	3/8	2 1/8	4	1 1/4	5.00	A	60A21	3/8	2.28
22	60B22	5.670	B	3/8	2 1/8	4	1 1/4	5.25	A	60A22	3/8	2.48
23	60B23	5.910	B	3/8	2 1/8	4	1 1/4	5.48	A	60A23	3/8	2.68
24	60B24	6.150	B	3/8	2 1/8	4	1 1/4	5.78	A	60A24	29/32	3.00
25	60B25	6.390	B	3/8	2 1/8	4	1 1/4	6.13	A	60A25	29/32	3.34
26	60B26	6.630	B	3/8	2 1/8	4	1 1/4	6.38	A	60A26	29/32	3.54
27	60B27	6.870	B	3/8	2 1/8	4	1 1/4	6.72	A	60A27	29/32	3.96
28	60B28	7.110	B	3/8	2 1/8	4	1 1/4	6.88	A	60A28	29/32	4.14
29	60B29	7.350	B	3/8	2 1/8	4	1 1/4	7.28	A	60A29	29/32	4.40
30	60B30	7.590	B	3/8	2 1/8	4	1 1/4	7.58	A	60A30	29/32	4.78
31	60B31	7.830	B	3/8	2 1/8	4	1 1/4	7.72	A	60A31	29/32	5.24
32	60B32	8.070	B	3/8	2 1/8	4	1 1/4	8.26	A	60A32	29/32	5.52
33	60B33	8.300	B	1	2 1/8	4	1 1/4	8.42	A	60A33	15/16	5.86
34	60B34	8.540	B	1	2 1/8	4	1 1/4	8.80	A	60A34	15/16	6.16
35	60B35	8.780	B	1	2 1/8	4	1 1/4	9.04	A	60A35	15/16	6.78
36	60B36	9.020	B	1	2 1/8	4	1 1/4	9.60	A	60A36	15/16	6.82
37	60B37	9.260	B	1	2 1/8	4	1 1/4	10.24	A	60A37	15/16	7.52
38	60B38	9.500	B	1	2 1/8	4 1/4	1 1/4	10.84	A	60A38	15/16	7.84
39	60B39	9.740	B	1	2 1/8	4 1/4	1 1/4	11.36	A	60A39	15/16	8.28
40	60B40	9.980	B	1	2 1/8	4 1/4	1 1/4	11.50	A	60A40	15/16	8.56
41	60B41	10.220	B	1	2 1/8	4 1/4	1 1/4	12.14	A	60A41	15/16	9.10
42	60B42	10.460	B	1	2 1/8	4 1/4	1 1/4	12.74	A	60A42	15/16	9.84
43	60B43	10.700	B	1	2 1/8	4 1/4	1 1/4	13.00	A	60A43	15/16	9.74
44	60B44	10.940	B	1 5/16	2 1/8	4 1/4	1 1/4	13.88	A	60A44	15/16	10.76
45	60B45	11.180	B	1 5/16	2 1/8	4 1/4	1 1/4	13.98	A	60A45	15/16	11.08
46	60B46	11.420	B	1 5/16	2 1/8	4 1/4	1 1/4	14.60	A	60A46	15/16	11.50
47	60B47	11.650	B	1 5/16	2 1/8	4 1/4	1 1/4	15.00	A	60A47	15/16	12.32
48	60B48	11.890	B	1 5/16	2 1/8	4 1/4	1 1/4	15.82	A	60A48	15/16	12.42
49	60B49	12.130	B	1 5/16	2 1/8	4 1/4	1 1/4	15.90	A	60A49	15/16	12.92
50	60B50	12.370	B	1 5/16	2 1/8	4 1/4	1 1/4	17.66	A	60A50	15/16	13.98
51	60B51	12.610	B	1 5/16	2 1/8	4 1/4	1 1/4	16.98	A	60A51	15/16	14.58
52	60B52	12.850	B	1 5/16	2 1/8	4 1/4	1 1/4	17.93	A	60A52	15/16	14.60
53	60B53	13.090	B	1 5/16	2 1/8	4 1/4	1 1/4	17.99	A	60A53	15/16	15.84
54	60B54	13.330	B	1 5/16	2 1/8	4 1/4	1 1/4	21.60	A	60A54	15/16	15.92
55	60B55	13.570	B	1 1/4	2 1/8	4 1/4	1 1/4	21.14	A	60A55	1 1/4	16.96
56	60B56	13.810	B	1 1/4	2 1/8	4 1/4	1 1/4	21.88	A	60A56	1 1/4	17.60
57	60B57	14.040	B	1 1/4	2 1/8	4 1/4	1 1/4	22.26	A	60A57	1 1/4	17.62
58	60B58	14.280	B	1 1/4	2 1/8	4 1/4	1 1/4	22.80	A	60A58	1 1/4	19.00
59	60B59	14.520	B	1 1/4	2 1/8	4 1/4	1 1/4	23.86	A	60A59	1 1/4	19.20
60	60B60	14.760	B	1 1/4	2 1/8	4 1/4	1 1/4	25.22	A	60A60	1 1/4	20.02
64	60B64	15.720	B	1 1/4	2 1/8	4 1/4	1 1/4	27.40	A	60A64	1 1/4	23.00
65	60B65	15.960	B	1 1/4	2 1/8	4 1/4	1 1/4	28.92	A	60A65	1 1/4	23.24
66									A	60A66	1 1/4	24.42
68	60B68	16.670	B	1 1/4	2 1/8	4 1/4	1 1/4	30.38	A	60A68	1 1/4	25.54
70	60B70	17.150	B	1 1/4	2 1/8	4 1/4	1 1/4	31.98	A	60A70	1 1/4	27.20
72	60B72	17.630	B	1 1/4	2 1/8	4 1/4	2	34.18	A	60A72	1 1/4	28.90
76	60B76	18.580	B	1 1/4	2 1/8	4 1/4	2	38.06	A	60A76	1 1/4	32.34
80	60B80	19.540	B	1 1/4	2 1/8	4 1/4	2	41.88	A	60A80	1 1/4	45.50
84	60B84	20.490	B	1 1/4	3 1/8	4 3/8	2	46.46	A	60A84	1 1/4	40.18
90	60B90	21.930	B	1 1/4	3 1/8	5	2 1/4	63.20	A	60A90	1 1/4	43.44
96	60B96	23.360	B	1 1/4	3 1/8	5 1/2	2 1/4	63.08	A	60A96	1 1/4	52.02
112	60B112	27.180	B	1 1/4	3 1/8	5 1/2	2 1/4	81.78	A	60A112	1 1/4	70.80

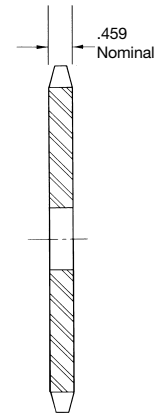

TYPE A

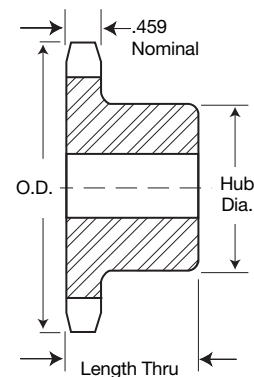

TYPE B

Alteration Charges

See current discount sheet for alteration charges.

★ Has recessed groove in hub for chain clearance.

Maximum bores shown will accommodate standard keyseat and setscrew over keyseat. Slightly larger bores are possible with no keyseat, shallow keyseat, or setscrew at angle to keyseat.

SPROCKETS

Martin

All Steel Stock Sprockets

No. 60

3/4" Pitch

Single-Type QD With Hardened Teeth

No. Teeth	Catalog Number
11	60JA11H
12	60JA12H
13	60JA13H
14	60SH14H
15	60SH15H
16	60SH16H
17	60SDS17H
18	60SDS18H
19	60SDS19H
20	60SDS20H
21	60SDS21H
22	60SDS22H
23	60SDS23H
24	60SDS24H
25	60SDS25H
26	60SK26H
27	60SK27H
28	60SK28H
30	60SK30H

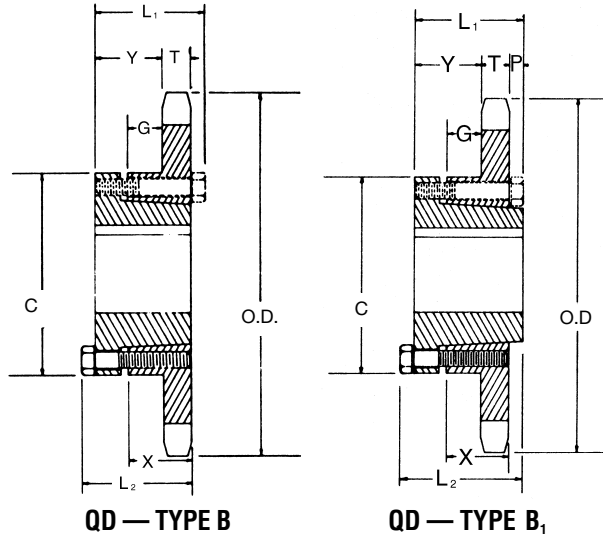

**SABER
TOOTH®**



SPROCKETS

Single-Type QD

No. Teeth	Catalog Number	Bush- ing	Diameters		Type	Max. Bore	Dimensions							Weight (Approx.)	
			Outside Diameter	Pitch Diameter			L ₁	L ₂	C	Y	G	X	T	With Hub	Rim Only
11	60JA11	JA	3.000	2.662	B	1 1/4	1 1/8	1 1/8	2 1/16	3/64	1 1/64	5/8	.459	1.36	.46
12	60JA12	JA	3.250	2.898	B	1 1/4	1 1/8	1 1/8	2 1/16	3/64	1 1/64	5/8	.459	1.50	.60
13	60JA13	JA	3.490	3.134	B	1 1/4	1 1/8	1 1/8	2 1/16	3/64	1 1/64	5/8	.459	1.66	.76
14	60SH14	SH	3.740	3.371	B	1 1/8	1 1/16	1 1/16	2 1/16	5/64	23/64	1 1/16	.459	1.88	.88
15	60SH15	SH	3.980	3.607	B	1 1/8	1 1/16	1 1/16	2 1/16	5/64	23/64	1 1/16	.459	2.08	1.08
16	60SH16	SH	4.220	3.844	B	1 1/8	1 1/16	1 1/16	2 1/16	5/64	23/64	1 1/16	.459	2.26	1.26
17	60SDS17	SDS	4.460	4.082	B	2	1 1/2	1 1/2	3 1/16	5/64	1 1/4	3/4	.459	2.38	1.38
18	60SDS18	SDS	4.700	4.319	B									2.56	1.56
19	60SDS19	SDS	4.950	4.557	B									2.76	1.76
20	60SDS20	SDS	5.190	4.794	B									3.00	2.00
21	60SDS21	SDS	5.430	5.032	B									3.20	2.20
22	60SDS22	SDS	5.670	5.270	B									3.44	2.44
23	60SDS23	SDS	5.910	5.508	B									3.70	2.70
24	60SDS24	SDS	6.150	5.746	B									3.94	2.94
25	60SDS25	SDS	6.390	5.984	B	2	1 1/2	1 1/2	3 1/16	5/64	1 1/4	3/4	.459	4.24	3.24
26	60SK26	SK	6.630	6.222	B	2 1/2	2 1/8	2 1/8	3 1/8	1 27/64	5 1/64	1 1/4	.459	6.18	4.18
27	60SK27	SK	6.870	6.460	B									6.52	4.52
28	60SK28	SK	7.110	6.699	B									6.72	4.72
30	60SK30	SK	7.590	7.175	B									7.34	5.34
32	60SK32	SK	8.070	7.652	B									8.10	6.10
35	60SK35	SK	8.780	8.367	B									9.42	7.42
36	60SK36	SK	9.020	8.605	B									9.70	7.70
40	60SK40	SK	9.980	9.559	B	2 1/2	2 1/8	2 1/8	3 1/8	1 27/64	5 1/64	1 1/4	.459	11.56	9.56
42	60SF42	SF	10.460	10.036	B	2 1/16	2 1/4	2 1/4	4 1/8	1 35/64	5 1/64	1 1/4	.459	13.78	10.78
45	60SF45	SF	11.180	10.752	B									15.40	12.40
48	60SF48	SF	11.890	11.467	B									17.26	14.26
54	60SF54	SF	13.330	12.899	B									20.02	17.02
60	60SF60	SF	14.760	14.331	B									23.76	20.76
70	60SF70	SF	17.150	16.717	B									31.60	28.60
72	60SF72	SF	17.630	17.194	B									32.58	29.58
80	60SF80	SF	19.540	19.103	B									41.24	38.24
84	60SF84	SF	20.490	20.058	B									43.94	40.94
96	60SF96	SF	23.360	22.922	B	2 1/16	2 1/4	2 1/4	4 1/8	1 35/64	5 1/64	1 1/4	.459	55.40	52.40
112	60E112	E	27.180	26.742	B1	3 1/2	2 1/2	2 1/16	6	2 1/16	1 1/4	1 1/8	.459	83.76	73.76

No. 60

3/4" Pitch

All Steel Stock Sprockets

Martin

Single-Taper Bushed with Hardened Teeth

No. Teeth	Catalog Number
11	60BTB11H
12	60BTB12H
13	60BTB13H
14	60BTB14H
15	60BTB15H
16	60BTB16H
17	60BTB17H
18	60BTB18H
19	60BTB19H
20	60BTB20H
21	60BTB21H
22	60BTB22H
23	60BTB23H
24	60BTB24H
25	60BTB25H
26	60BTB26H
27	60BTB27H
28	60BTB28H
30	60BTB30H

**SABER
TOOTH®**

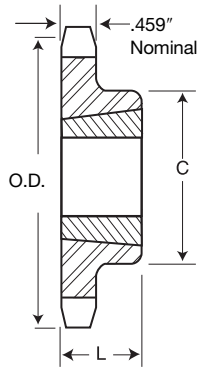

**TAPER BUSH
TYPE B**



SPROCKETS

Single-Taper Bushed

No. Teeth	Catalog Number	Bushing	Diameters		Max. Bore	Dimensions		Type	Weight (Approx.)	
			Outside Diameter	Pitch Diameter		L	C		Rim Only	Bushing Only
11	60BTB11	1008	3.004	2.662	1	7/8	1 1/16	B	.6	.3
12	60BTB12	1008	3.249	2.898	1	7/8	1 1/16	B	.8	.3
13	60BTB13	1210	3.493	3.134	1 1/4	1	2 1/32★	B	.8	.6
14	60BTB14	1210	3.736	3.371	1 1/4	1	2 19/32	B	1.0	.6
15	60BTB15	1610	3.979	3.607	1 1/2	1	2 29/32	B	1.0	.9
16	60BTB16	1610	4.221	3.844	1 1/2	1	3	B	1.4	.9
17	60BTB17	1610	4.462	4.082	1 1/2	1	3 1/4	B	1.8	.9
18	60BTB18	1610	4.704	4.319	1 1/2	1	3 1/2	B	1.9	.9
19	60BTB19	1610	4.945	4.557	1 1/2	1	3 1/2	B	2.2	.9
20	60BTB20	2012	5.185	4.794	2	1 1/4	3 5/16	B	2.2	1.7
21	60BTB21	2012	5.426	5.032	2	1 1/4	4	B	2.5	1.7
22	60BTB22	2012	5.666	5.270	2	1 1/4	4	B	2.8	1.7
23	60BTB23	2012	5.907	5.508	2	1 1/4	4	B	3.1	1.7
24	60BTB24	2012	6.147	5.746	2	1 1/4	3 9/16	B	3.4	1.7
25	60BTB25	2012	6.387	5.984	2	1 1/4	3 9/16	B	3.7	1.7
26	60BTB26	2012	6.627	6.222	2	1 1/4	3 9/16	B	4.0	1.7
27	60BTB27	2012	6.867	6.416	2	1 1/4	3 9/16	B	4.2	1.7
28	60BTB28	2012	7.107	6.699	2	1 1/4	3 9/16	B	4.6	1.7
30	60BTB30	2012	7.586	7.175	2	1 1/4	3 9/16	B	5.2	1.7
32	60BTB32	2012	8.065	7.652	2	1 1/4	3 9/16	B	5.6	1.7
35	60BTB35	2012	8.783	8.367	2	1 1/4	3 9/16	B	6.4	1.7
36	60BTB36	2012	9.022	8.605	2	1 1/4	3 9/16	B	6.6	1.7
40	60BTB40	2012	9.980	9.559	2	1 1/4	3 9/16	B	8.3	1.7
42	60BTB42	2012	10.458	10.036	2	1 1/4	3 9/16	B	10.0	1.7
45	60BTB45	2012	11.175	10.752	2	1 1/4	3 9/16	B	11.5	1.7
48	60BTB48	2012	11.893	11.467	2	1 1/4	3 9/16	B	13.2	1.7
54	60BTB54	2517	13.327	12.899	2 1/2	1 1/4	4 1/4	B	17.1	3.5
60	60BTB60	2517	14.761	14.330	2 1/2	1 1/4	4 1/4	B	21.0	3.5
70	60BTB70	2517	17.150	16.717	2 1/2	1 1/4	4 1/4	B	27.6	3.5
72	60BTB72	2517	17.628	17.194	2 1/2	1 1/4	4 1/4	B	30.0	3.5
80	60BTB80	2517	19.539	19.103	2 1/2	1 1/4	4 1/4	B	36.3	3.5
84	60BTB84	2517	20.494	20.058	2 1/2	1 1/4	4 1/4	B	40.6	3.5

★ Has recessed groove in hub for chain clearance.

Martin

MST[®] Sprockets

No. 60 3/4" Pitch

Single - MST[®] Sprockets

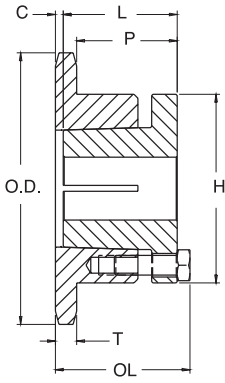

TYPE 3

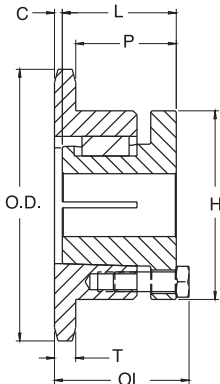

TYPE 4

No. Teeth	Catalog Number	Bush-ing	Diameters		Type	Max. Bore	Dimensions					Weight (Approx.)		
			Outside Dia.	Pitch Dia.			OL	L	C	H	P	T(nom)	With Hub	Rim Only
11	60H11H	H	3.000	2.662	3	1-1/2	1-13/16	1-1/4	3/8	2-1/2	1-5/32	.459	1.5	.7
12	60H12H	H	3.250	2.898	3	1-1/2	1-3/4	1-1/4	5/16	2-1/2	1-3/32	.459	1.6	.8
13	60H13H	H	3.490	3.134	3	1-1/2	1-1/2	1-1/4	1/16	2-1/2	27/32	.459	1.6	.8
13	60P13H	P1	3.490	3.134	4	1-3/4	2-3/16	1-15/16	0	3	1-15/32	.459	2.5	1.2
14	60H14H	H	3.740	3.371	3	1-1/2	1-1/2	1-1/4	1/16	2-1/2	27/32	.459	1.9	1.1
14	60P14H	P1	3.740	3.371	4	1-3/4	2-3/16	1-15/16	0	3	1-15/32	.459	2.7	1.4
15	60H15H	H	3.980	3.607	3	1-1/2	1-1/2	1-1/4	1/16	2-1/2	27/32	.459	2.2	1.4
15	60P15H	P1	3.980	3.607	4	1-3/4	2-3/16	1-15/16	0	3	1-15/32	.459	3.0	1.7
16	60H16H	H	4.220	3.844	3	1-1/2	1-1/2	1-1/4	1/16	2-1/2	27/32	.459	2.1	1.3
16	60P16H	P1	4.220	3.844	4	1-3/4	2-3/16	1-15/16	0	3	1-15/32	.459	3.1	1.8
17	60H17H	H	4.460	4.082	3	1-1/2	1-1/2	1-1/4	1/16	2-1/2	27/32	.459	2.3	1.5
17	60P17H	P1	4.460	4.082	4	1-3/4	2-3/16	1-15/16	0	3	1-15/32	.459	3.4	2.1
18	60H18H	H	4.700	4.319	3	1-1/2	1-1/2	1-1/4	1/16	2-1/2	27/32	.459	2.5	1.7
18	60P18H	P1	4.700	4.319	4	1-3/4	2-3/16	1-15/16	0	3	1-15/32	.459	3.5	2.2
19	60H19H	H	4.950	4.557	3	1-1/2	1-1/2	1-1/4	1/16	2-1/2	27/32	.459	2.7	1.9
19	60P19H	P1	4.950	4.557	4	1-3/4	2-3/16	1-15/16	0	3	1-15/32	.459	3.8	2.5
20	60H20H	H	5.190	4.794	3	1-1/2	1-1/2	1-1/4	1/16	2-1/2	27/32	.459	2.9	2.1
20	60P20H	P1	5.190	4.794	4	1-3/4	2-3/16	1-15/16	0	3	1-15/32	.459	4.4	3.1
20	60Q20H	Q1	5.190	4.794	4	2-11/16	2-25/32	2-1/2	0	4-1/8	2-1/32	.459	7.0	3.5
21	60P21H	P1	5.430	5.032	4	1-3/4	2-3/16	1-15/16	0	3	1-15/32	.459	4.2	2.9
21	60Q21H	Q1	5.430	5.032	4	2-11/16	2-25/32	2-1/2	0	4-1/8	2-1/32	.459	7.1	3.6
22	60H22H	H	5.670	5.270	3	1-1/2	1-1/2	1-1/4	1/16	2-1/2	27/32	.459	3.4	2.6
22	60P22H	P1	5.670	5.270	4	1-3/4	2-3/16	1-15/16	0	3	1-15/32	.459	4.5	3.2
22	60Q22H	Q1	5.670	5.270	4	2-11/16	2-25/32	2-1/2	0	4-1/8	2-1/32	.459	7.5	4.0
23	60P23H	P1	5.910	5.508	4	1-3/4	2-3/16	1-15/16	0	3	1-15/32	.459	4.8	3.5
23	60Q23H	Q1	5.910	5.508	4	2-11/16	2-25/32	2-1/2	0	4-1/8	2-1/32	.459	7.6	4.1
24	60H24H	H	6.150	5.746	3	1-1/2	1-1/2	1-1/4	1/16	2-1/2	27/32	.459	3.8	3.0
24	60P24H	P1	6.150	5.746	4	1-3/4	2-3/16	1-15/16	0	3	1-15/32	.459	5.1	3.8
24	60Q24H	Q1	6.150	5.746	4	2-11/16	2-25/32	2-1/2	0	4-1/8	2-1/32	.459	8.0	4.5
25	60P25H	P1	6.390	5.984	4	1-3/4	2-3/16	1-15/16	0	3	1-15/32	.459	5.4	4.1
25	60Q25H	Q1	6.390	5.984	4	2-11/16	2-25/32	2-1/2	0	4-1/8	2-1/32	.459	9.4	5.9
26	60P26H	P1	6.630	6.222	4	1-3/4	2-3/16	1-15/16	0	3	1-15/32	.459	5.6	4.3
26	60Q26H	Q1	6.630	6.222	4	2-11/16	2-25/32	2-1/2	0	4-1/8	2-1/32	.459	9.8	6.3
27	60P27H	P1	6.870	6.460	4	1-3/4	2-3/16	1-15/16	0	3	1-15/32	.459	5.8	4.5
27	60Q27H	Q1	6.870	6.460	4	2-11/16	2-25/32	2-1/2	0	4-1/8	2-1/32	.459	9.9	6.4
28	60P28H	P1	7.110	6.699	4	1-3/4	2-3/16	1-15/16	0	3	1-15/32	.459	6.2	4.9
28	60Q28H	Q1	7.110	6.699	4	2-11/16	2-25/32	2-1/2	0	4-1/8	2-1/32	.459	10.4	6.9
29	60Q29H	Q1	7.350	6.937	4	2-11/16	2-25/32	2-1/2	0	4-1/8	2-1/32	.459	10.8	7.3
30	60P30H	P1	7.590	7.175	4	1-3/4	2-3/16	1-15/16	0	3	1-15/32	.459	6.9	5.6
30	60Q30H	Q1	7.590	7.175	4	2-11/16	2-25/32	2-1/2	0	4-1/8	2-1/32	.459	11.1	7.6
31	60Q31	Q1	7.830	7.413	4	2-11/16	2-25/32	2-1/2	0	4-1/8	2-1/32	.459	11.3	7.8
32	60Q32	Q1	8.070	7.652	4	2-11/16	2-25/32	2-1/2	0	4-1/8	2-1/32	.459	11.8	8.3
33	60Q33	Q1	8.300	7.890	4	2-11/16	2-25/32	2-1/2	0	4-1/8	2-1/32	.459	12.2	8.7
34	60Q34	Q1	8.540	8.129	4	2-11/16	2-25/32	2-1/2	0	4-1/8	2-1/32	.459	12.6	9.1
35	60Q35	Q1	8.780	8.367	4	2-11/16	2-25/32	2-1/2	0	4-1/8	2-1/32	.459	12.8	9.3
36	60Q36	Q1	9.020	8.605	4	2-11/16	2-25/32	2-1/2	0	4-1/8	2-1/32	.459	13.4	9.9
37	60Q37	Q1	9.260	8.844	4	2-11/16	2-25/32	2-1/2	0	4-1/8	2-1/32	.459	13.8	10.3
38	60Q38	Q1	9.500	9.082	4	2-11/16	2-25/32	2-1/2	0	4-1/8	2-1/32	.459	14.1	10.6
39	60Q39	Q1	9.740	9.321	4	2-11/16	2-25/32	2-1/2	0	4-1/8	2-1/32	.459	14.6	11.1
40	60Q40	Q1	9.980	9.559	4	2-11/16	2-25/32	2-1/2	0	4-1/8	2-1/32	.459	15.1	11.6
41	60Q41	Q1	10.220	9.798	4	2-11/16	2-25/32	2-1/2	0	4-1/8	2-1/32	.459	15.4	11.9
42	60Q42	Q1	10.460	10.036	4	2-11/16	2-25/32	2-1/2	0	4-1/8	2-1/32	.459	16.1	12.6
44	60Q44	Q1	10.940	10.513	4	2-11/16	2-25/32	2-1/2	0	4-1/8	2-1/32	.459	16.9	13.4
45	60Q45	Q1	11.180	10.752	4	2-11/16	2-25/32	2-1/2	0	4-1/8	2-1/32	.459	17.4	13.9
47	60Q47	Q1	11.650	11.229	4	2-11/16	2-25/32	2-1/2	0	4-1/8	2-1/32	.459	19.8	16.3
48	60Q48	Q1	11.890	11.467	4	2-11/16	2-25/32	2-1/2	0	4-1/8	2-1/32	.459	19.9	16.4
50	60Q50	Q1	12.370	11.945	4	2-11/16	2-25/32	2-1/2	0	4-1/8	2-1/32	.459	20.4	16.9
54	60Q54	Q1	13.330	12.899	4	2-11/16	2-25/32	2-1/2	0	4-1/8	2-1/32	.459	23.1	19.6
56	60Q56	Q1	13.810	13.376	4	2-11/16	2-25/32	2-1/2	0	4-1/8	2-1/32	.459	23.8	20.3
60	60Q60	Q1	14.760	14.331	4	2-11/16	2-25/32	2-1/2	0	4-1/8	2-1/32	.459	26.4	22.9
70	60Q70	Q1	17.150	16.717	4	2-11/16	2-25/32	2-1/2	0	4-1/8	2-1/32	.459	34.4	30.9
70	60R70	R1	17.150	16.717	4	3-3/4	3-5/32	2-7/8	0	5-3/8	2-13/32	.459	39.3	31.8
72	60Q72	Q1	17.630	17.194	4	2-11/16	2-25/32	2-1/2	0	4-1/8	2-1/32	.459	35.4	31.9
72	60R72	R1	17.630	17.194	4	3-3/4	3-5/32	2-7/8	0	5-3/8	2-13/32	.459	41.6	34.1
80	60Q80	Q1	19.540	19.103	4	2-11/16	2-25/32	2-1/2	0	4-1/8	2-1/32	.459	42.6	39.1
80	60R80	R1	19.540	19.103	4	3-3/4	3-5/32	2-7/8	0	5-3/8	2-13/32	.459	49.0	41.5
84	60Q84	Q1	20.490	20.058	4	2-11/16	2-25/32	2-1/2	0	4-1/8	2-1/32	.459	45.1	41.6
84	60R84	R1	20.490	20.058	4	3-3/4	3-5/32	2-7/8	0	5-3/8	2-13/32	.459	52.3	44.8
96	60Q96	Q1	23.360	22.922	4	2-11/16	2-25/32	2-1/2	0	4-1/8	2-1/32	.459	57.5	54.0
96	60R96	R1	23.360	22.922	4	3-3/4	3-5/32	2-7/8	0	5-3/8	2-13/32	.459	63.5	56.0
112	60Q112	Q1	27.180	26.742	4	2-11/16	2-25/32	2-1/2	0	4-1/8	2-1/32	.459	76.5	73.0
112	60R112	R1	27.180	26.742	4	3-3/4	3-5/32	2-7/8	0	5-3/8	2-13/32	.459	82.0	74.5

Sprockets with "H" suffix have hardened teeth.

SPROCKETS

No. 60-2

3/4" Pitch

All Steel Stock Sprockets

Martin

Double-Type B & C

No. Teeth	Catalog Number	Outside Diameter	Type	Bore (inches)		Hub (inches)		Weight Lbs. (Approx.)
				Stock	Rec. Max.	Dia.	Length Thru	
11	D60B11H	3.000	B	1	1 1/4	1 1/16	2 1/2	1.62
12	D60B12H	3.250	B	1	1 1/8	2 1/2	2 1/2	2.20
13	D60B13H	3.490	B	1	1 1/2	2 1/4	2 1/2	2.60
14	D60B14H	3.740	B	1	1 3/4	2 1/2	2 1/2	3.24
15	D60B15H	3.980	B	1	1 7/8	2 1/2	2 1/2	3.96
16	D60B16H	4.220	B	1	2	3	2 1/2	4.62
17	D60B17H	4.460	B	1	2 1/4	3 1/4	2 1/2	5.40
18	D60B18H	4.700	B	1	2 1/2	3 1/2	2 1/2	6.24
19	D60B19H	4.950	B	1	2 3/4	3 1/16	2 1/2	7.00
20	D60B20H	5.190	B	1	2 1/2	3 3/4	2 1/2	7.72
21	D60B21H	5.430	B	1	2 3/4	4 1/2	2 1/2	8.82
22	D60B22H	5.670	B	1	2 3/4	4 1/2	2 1/2	9.68
23	D60B23H	5.910	B	1	2 3/4	4 1/2	2 1/2	10.30
24	D60B24H	6.150	B	1	2 3/4	4 1/2	2 1/2	11.14
25	D60B25H	6.390	B	1	2 3/4	4 1/2	2 1/2	11.96
26	D60B26	6.630	B	1	2 3/4	4 1/2	2 1/2	12.70
30	D60B30	7.590	B	1	2 3/4	4 1/2	2 1/2	16.36
32	D60B32	8.070	B	1 1/4	3	4 1/2	2 1/2	19.52
35	D60B35	8.780	B	1 1/4	3	4 1/2	2 1/2	22.80
36	D60B36	9.020	B	1 1/4	3	4 1/2	2 1/2	23.82
40	D60B40	9.980	B	1 1/4	3 1/4	4 1/2	2 1/2	30.84
42	D60B42	10.460	B	1 1/4	3 1/4	4 1/2	2 1/2	33.08
45	D60B45	11.180	B	1 1/4	3 1/4	4 1/2	2 1/2	37.08
52	D60B52	12.850	B	1 1/4	3 1/4	4 1/2	2 1/2	48.70
60	D60B60	14.760	B	1 1/4	3 1/4	4 1/2	2 1/2	63.10
68	D60C68	16.670	C	1 1/4	3 3/16	5	3	53.68
72	D60C72	17.630	C	1 1/4	3 3/16	5	3	53.74
76	D60C76	18.580	C	1 1/4	3 3/16	5	3	60.28
95	D60C95	23.120	C	1 1/4	3 3/16	5 1/2	3 1/2	87.14

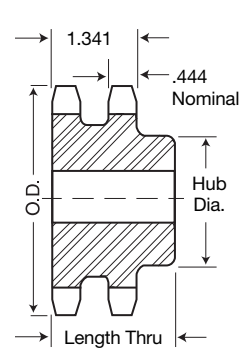

TYPE B

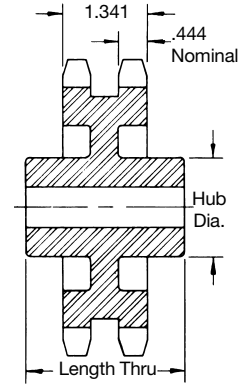

TYPE C

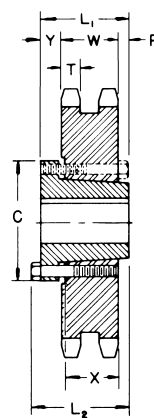

QD — TYPE C₁

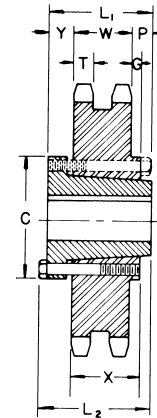

QD — TYPE C₂

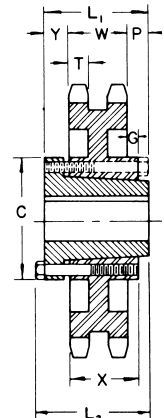

QD — TYPE C₄

Maximum bores shown will accommodate standard keyseat and setscrew over keyseat. Slightly larger bores are possible with no keyseat, shallow keyseat, or setscrew at angle to keyseat.

NOTE: Double 60 stock sprockets with 25 teeth or less have hardened teeth. As indicated by H suffix.

Alteration Charges

See current discount sheet for alteration charges.

Double-Type QD

No. Teeth	Catalog Number	Bush-ing	Diameters		Type	Max. Bore	Dimensions										Weight (Approx.)	
			Outside Diameter	Pitch Diameter			L ₁	L ₂	C	Y	P	G	X	T	W	With Hub	Rim Only	
14	D60SH14H	SH	3.740	3.371	B*	1 1/8	1 3/16	1 1/2	2 1/16	1/2					.444	1.341	2.5	1.5
22	D60SDS22H	SDS	5.670	5.270	B*	2	1 1/2	1 3/4	3 1/16						.444	1.341	5.44	4.44
36	D60SF36	SF	9.020	8.605	C1	2 1/16	2	2 1/4	4 5/8	3/4				1 1/4	.444	1.341	19.26	16.26
42	D60E42	E	10.460	10.036	C2	3 1/8	2 1/2	2 5/8	6	1 1/8	1/2	1/2		1 1/2	.444	1.341	34.04	24.04
45	D60E45	E	11.180	10.752	C2												38.26	28.36
52	D60E52	E	12.850	12.422	C2												49.52	39.52
60	D60E60	E	14.760	14.331	C2												63.39	53.74
68	D60E68	E	16.670	16.240	C4												54.32	44.32
76	D60E76	E	18.580	18.149	C4												61.48	51.48
95	D60E95	E	23.120	22.683	C4	3 1/2	2 3/4	2 5/8	6	7/8	1 1/2	1/2		1 1/2	.444	1.341	82.96	72.96

* Not illustrated. Dimensions listed correspond approximately to illustrations shown.

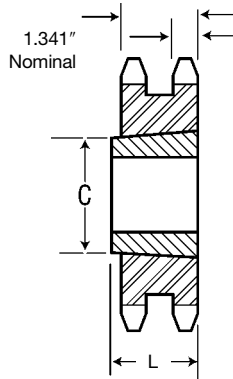
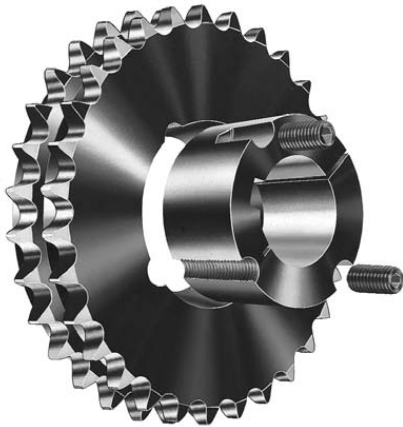

TYPE A

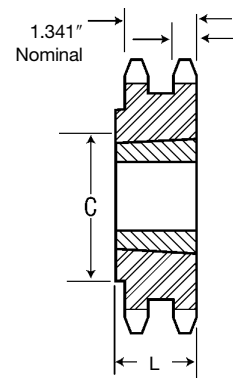

TYPE B

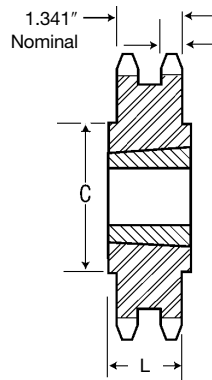

TYPE C₁

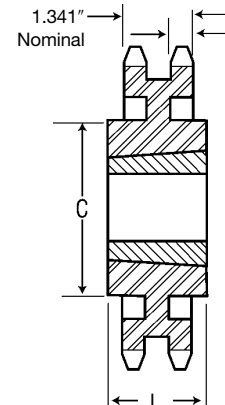

TYPE C

Double-Taper Bushed

No. Teeth	Catalog Number	Bushing	Diameters		Max. Bore	Dimensions			Weight (Approx.)	
			Outside Diameter	Pitch Diameter		L	C	Type	Rim Only	Bushing Only
13	D60BTB13H	1215	3.493	3.134	1 1/4	1 1/2	2 1/4	B	1.2	1.6
14	D60BTB14H	1215	3.736	3.371	1 1/4	1 1/2	2 1/2	B	1.6	1.7
15	D60BTB15H	1615	3.979	3.607	1 1/2	1 1/2	2 3/8	B	1.3	1.8
16	D60BTB16H	1615	4.221	3.844	1 1/2	1 1/2	3	B	2.2	2.3
17	D60BTB17H	1615	4.462	4.082	1 1/2	1 1/2	3 1/4	B	2.5	2.8
18	D60ATB18H	2012	4.704	4.319	2	1 1/2		A	3.0	2.4
19	D60ATB19H	2012	4.945	4.557	2	1 1/2		A	3.5	2.9
20	D60BTB20H	2517	5.185	4.794	2 1/2	1 1/2	3 5/8	B	4.0	2.9
21	D60BTB21H	2517	5.426	5.032	2 1/2	1 1/2	4 1/8	B	5.0	3.8
25	D60BTB25H	2517	6.387	4.984	2 1/2	1 1/2	5 1/2	B	7.5	7.4
30	D60BTB30	2517	7.586	7.175	2 1/2	1 1/2	6 1/2	B	13.5	13.3
36	D60CTB36	2517	9.022	8.605	2 1/2	1 1/2	4 1/4	C	17.5	17.4
42	D60CTB42	2517	10.458	10.036	2 1/2	1 1/2	4 1/4	C	25.5	25.0
45	D60CTB45	2517	11.176	10.752	2 1/2	1 1/2	4 1/4	C	29.5	29.3
52	D60CTB52	2517	12.849	12.422	2 1/2	1 1/2	4 1/4	C	41.0	40.3
60	D60CTB60	2517	14.761	14.330	2 1/2	1 1/2	4 1/4	C 1	32.5	33.5
68	D60CTB68	2517	16.672	16.240	2 1/2	1 1/2	4 1/4	C 1	36.5	43.2
76	D60CTB76	3020	18.583	18.149	3	2	5 1/4	C 1	42.5	47.8
95	D60CTB95	3020	23.121	22.684	3	2	5 1/4	C 1	48.5	69.8

NOTE: Double 60 stock sprockets with 25 teeth or less have hardened teeth.

No. 60-2

3/4" Pitch

MST[®]

Sprockets

Martin

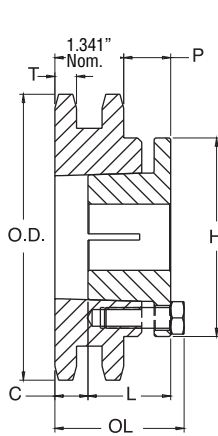

TYPE 11

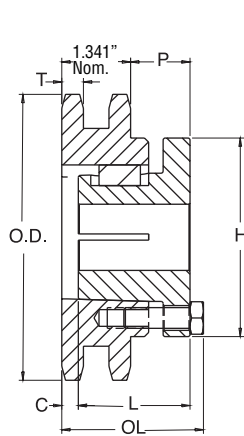

TYPE 12

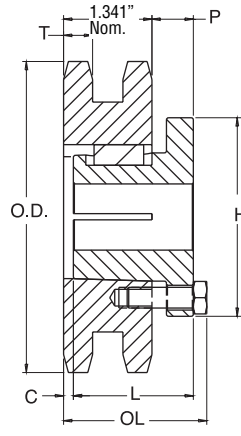

TYPE 13

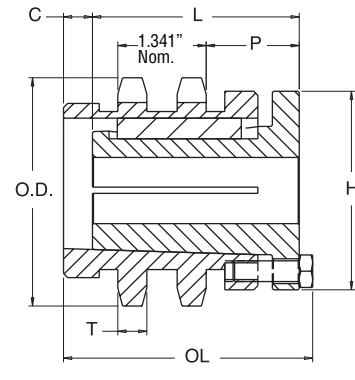

TYPE 16

SPROCKETS

Double - MST[®] Sprockets

No. Teeth	Catalog Number	Bush-ing	Diameters		Type	Max. Bore	Dimensions						Weight (Approx.)	
			Outside Dia.	Pitch Dia.			OL	L	C	H	P	T(nom)	With Hub	Rim Only
13	D60P13H	P1	3.490	3.134	16	1-3/4	3-13/16	1-15/16	1 5/8	3	1-13/32	.444	3.8	2.5
14	D60P14H	P1	3.740	3.371	12	1-3/4	3	1-15/16	13/16	3	1-13/32	.444	3.6	2.3
15	D60P15H	P1	3.980	3.607	12	1-3/4	3	1-15/16	13/16	3	1-13/32	.444	4.0	2.7
16	D60P16H	P1	4.220	3.844	13	1-3/4	2-7/32	1-15/16	1/32	3	5/8	.444	3.7	2.4
17	D60P17H	P1	4.460	4.082	13	1-3/4	2-7/32	1-15/16	1/32	3	5/8	.444	4.1	2.8
18	D60P18H	P1	4.700	4.319	13	1-3/4	2-7/32	1-15/16	1/32	3	5/8	.444	4.7	3.4
19	D60P19H	P1	4.950	4.557	13	1-3/4	2-7/32	1-15/16	1/32	3	5/8	.444	5.3	4.0
20	D60P20H	P1	5.190	4.794	13	1-3/4	2-7/32	1-15/16	1/32	3	5/8	.444	6.0	4.7
21	D60Q21H	Q1	5.430	5.032	12	2-11/16	2-25/32	2-1/2	0	4-1/8	1-5/32	.444	8.3	4.8
22	D60Q22H	Q1	5.670	5.270	12	2-11/16	2-25/32	2-1/2	0	4-1/8	1-5/32	.444	9.1	5.6
23	D60Q23H	Q1	5.910	5.508	12	2-11/16	2-25/32	2-1/2	0	4-1/8	1-5/32	.444	9.8	6.3
24	D60Q24H	Q1	6.150	5.746	12	2-11/16	2-25/32	2-1/2	0	4-1/8	1-5/32	.444	10.5	7.0
25	D60Q25H	Q1	6.390	5.984	12	2-11/16	2-25/32	2-1/2	0	4-1/8	1-5/32	.444	11.4	7.9
26	D60Q26H	Q1	6.630	6.222	12	2-11/16	2-25/32	2-1/2	0	4-1/8	1-5/32	.444	12.3	8.8
27	D60Q27H	Q1	6.870	6.460	12	2-11/16	2-25/32	2-1/2	0	4-1/8	1-5/32	.444	13.1	9.6
28	D60Q28H	Q1	7.110	6.699	12	2-11/16	2-25/32	2-1/2	0	4-1/8	1-5/32	.444	14.0	10.5
30	D60Q30H	Q1	7.590	7.175	12	2-11/16	2-25/32	2-1/2	0	4-1/8	1-5/32	.444	15.8	12.3
32	D60Q32H	Q1	8.070	7.652	12	2-11/16	2-25/32	2-1/2	0	4-1/8	1-5/32	.444	17.8	14.3
35	D60Q35H	Q1	8.780	8.367	12	2-11/16	2-25/32	2-1/2	0	4-1/8	1-5/32	.444	21.2	17.7
36	D60Q36H	Q1	9.020	8.605	12	2-11/16	2-25/32	2-1/2	0	4-1/8	1-5/32	.444	21.9	18.4
40	D60Q40H	Q1	9.980	9.559	12	2-11/16	2-25/32	2-1/2	0	4-1/8	1-5/32	.444	27.4	23.9
42	D60Q42	Q1	10.460	10.036	12	2-11/16	2-25/32	2-1/2	0	4-1/8	1-5/32	.444	29.8	26.3
42	D60R42	R1	10.460	10.036	12	3-3/4	3-5/32	2-7/8	0	5-3/8	1 17/32	.444	33.2	25.7
45	D60R45	R1	11.180	10.752	12	3-3/4	3-5/32	2-7/8	0	5-3/8	1 17/32	.444	37.7	30.2
48	D60R48	R1	11.890	11.467	12	3-3/4	3-5/32	2-7/8	0	5-3/8	1 17/32	.444	42.6	35.1
52	D60R52	R1	12.850	12.422	12	3-3/4	3-5/32	2-7/8	0	5-3/8	1 17/32	.444	49.3	41.8
54	D60R54	R1	13.330	12.899	12	3-3/4	3-5/32	2-7/8	0	5-3/8	1 17/32	.444	52.6	45.1
60	D60R60	R1	14.760	14.331	12	3-3/4	3-5/32	2-7/8	0	5-3/8	1 17/32	.444	62.3	54.8
68	D60R68	R1	16.670	16.240	12	3-3/4	3-5/32	2-7/8	0	5-3/8	1 17/32	.444	81.3	73.8
72	D60R72	R1	17.630	17.194	12	3-3/4	3-5/32	2-7/8	0	5-3/8	1 17/32	.444	89.3	81.8
76	D60R76	R1	18.580	18.149	12	3-3/4	3-5/32	2-7/8	0	5-3/8	1 17/32	.444	100.5	93.0
84	D60R84	R1	20.490	20.058	12	3-3/4	3-5/32	2-7/8	0	5-3/8	1 17/32	.444	118.5	111.0
95	D60R95	R1	23.120	22.683	12	3-3/4	3-5/32	2-7/8	0	5-3/8	1 17/32	.444	155.5	148.0
96	D60R96	R1	23.360	22.922	12	3-3/4	3-5/32	2-7/8	0	5-3/8	1 17/32	.444	162.5	155.0

Sprockets with "H" suffix have hardened teeth.

Triple-Type B & C

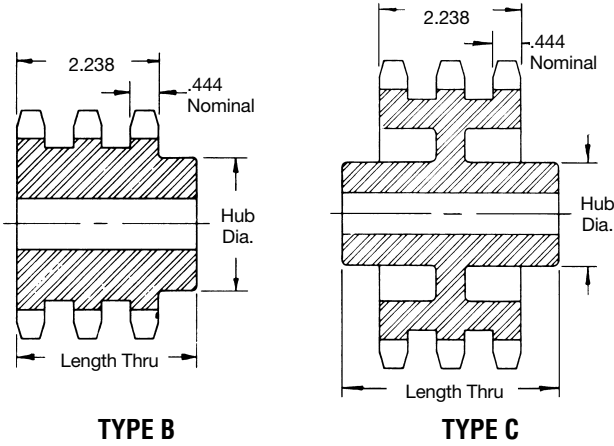

No. Teeth	Catalog Number	Outside Diameter	Type	Bore (inches)		Hub (inches)		Weight Lbs. (Approx.)
				Stock	Rec. Max.	Dia.	Length Thru	
11	E60B11H	3.000	B	1	1 1/4	1 1/16	3	2.5
12	E60B12H	3.250	B	1	1 1/4	2 1/16	3	3.3
13	E60B13H	3.490	B	1	1 1/2	2 1/4	3	3.9
14	E60B14H	3.740	B	1	1 1/2	2 1/2	3	4.5
15	E60B15H	3.980	B	1	1 1/2	2 3/16	3	5.4
16	E60B16H	4.220	B	1	2	3	3	6.5
17	E60B17H	4.460	B	1	2 1/4	3 1/4	3	7.7
18	E60B18H	4.700	B	1	2 1/2	3 1/2	3	8.5
19	E60B19H	4.950	B	1	2 1/2	3 1/16	3	10.0
20	E60B20H	5.190	B	1	2 1/2	3 3/8	3	11.2
21	E60B21H	5.430	B	1	2 1/2	4	3	12.5
22	E60B22H	5.670	B	1	2 1/2	4 1/4	3	13.2
23	E60B23H	5.910	B	1	2 1/2	4 1/2	3	14.6
24	E60B24H	6.150	B	1	2 1/2	4 3/4	3	15.8
25	E60B25H	6.390	B	1	2 1/2	4 1/2	3	17.0
26	E60B26	6.630	B	1	2 1/2	4 1/4	3	18.6
30	E60B30	7.590	B	1	2 1/2	4 1/2	3	23.2
35	E60B35	8.780	B	1 1/2	3	4 1/2	3 1/2	34.5
36	E60B36	9.020	B	1 1/2	3	4 1/2	3 1/2	37.0
42	E60B42	10.460	B	1 1/2	3 1/2	4 1/2	3 1/2	49.0
45	E60B45	11.180	B	1 1/2	3 1/2	4 1/2	3 1/2	57.0
52	E60C52	12.850	C	1 1/2	3 1/2	4 1/2	3 1/2	73.0
60	E60C60	14.760	C	1 1/2	3 1/2	4 1/2	3 1/2	63.0
68	E60C68	16.670	C	1 1/2	3 1/2	5	3 1/2	73.0
72	E60C72	17.630	C	1 1/2	3 1/2	5	3 1/2	85.0
76	E60C76	18.580	C	1 1/2	3 1/2	5 1/2	3 1/2	82.0
95	E60C95	23.120	C	1 1/2	3 1/2	5 1/2	4	105.0

Maximum bores shown will accommodate standard keyseat and setscrew over keyseat. Slightly larger bores are possible with no keyseat, shallow keyseat, or setscrew at angle to keyseat.

NOTE: Triple 60 stock sprockets with 25 teeth or less have hardened teeth. As indicated by H suffix.



Alteration Charges

See current discount sheet for alteration charges.

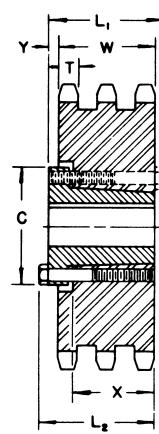

QD — TYPE B

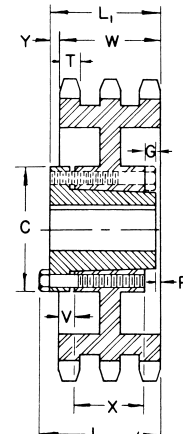

QD — TYPE B₁

Triple-Type QD

No. Teeth	Catalog Number	Bush-ing	Diameters		Type	Max. Bore	Dimensions										Weight (Approx.)	
			Outside Diameter	Pitch Diameter			L ₁	L ₂	C	Y	P	G	V	X	T	W	With Hub	Rim Only
36	E60E36	E	9.020	8.605	B	3 1/2	2 1/2	2 1/16	6	1 1/4	1/2			1 1/2	.444	2.238	49	37
42	E60E42	E	10.460	10.036	B	3 1/2	2 1/2	2 1/16	6	1 1/4	1/2			1 1/2	.444	2.238	62	50
52	E60E52	E	12.850	12.422	B	3 1/2	2 1/2	2 1/16	6	1 1/4	1/2			1 1/2	.444	2.238	80	68
68	E60E68	E	16.670	16.240	B1	3 1/2	2 1/16	3 3/4	6	1 1/2	1/2	1/2	1/2	1 1/2	.444	2.238	83	71
76	E60E76	E	18.580	18.149	B1	3 1/2	2 1/16	3 3/4	6	1 1/2	1/2	1/2	1/2	1 1/2	.444	2.238	99	87
95	E60E95	E	23.120	22.683	B1	3 1/2	2 1/16	3 3/4	6	1 1/2	1/2	1/2	1/2	1 1/2	.444	2.238	129	117

No. 60-3

3/4" Pitch

MST[®] Sprockets

Martin

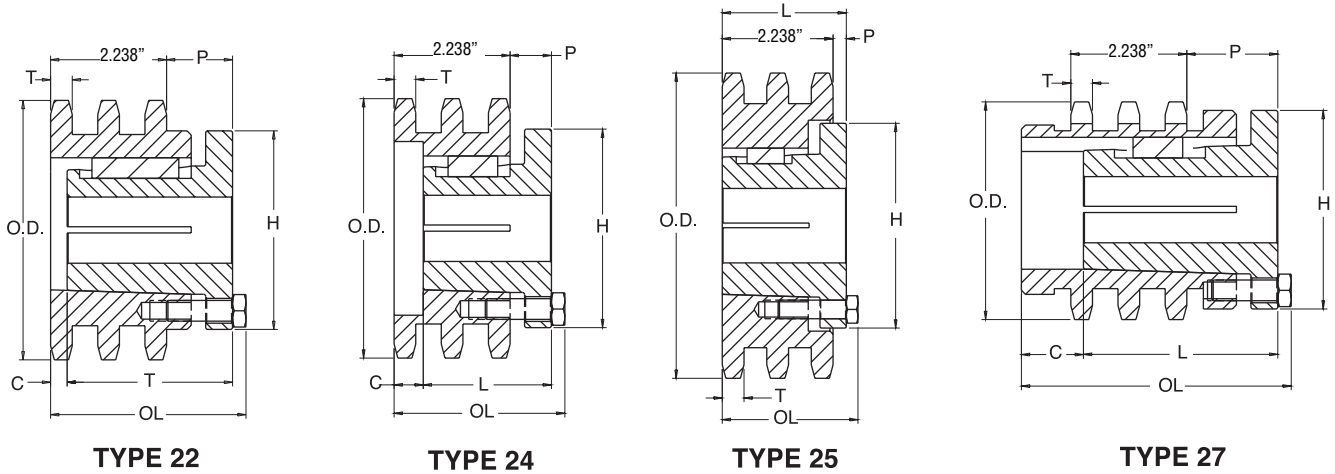

SPROCKETS

Triple - MST[®] Sprockets

No. Teeth	Catalog Number	Bush-ing	Diameters		Type	Max. Bore	Dimensions						Weight (Approx.)	
			Outside Dia.	Pitch Dia.			OL	L	C	H	P	T(nom)	With Hub	Rim Only
13	E60P13H	P2	3.490	3.134	27	1-3/4	4 23/32	2-15/16	1 17/32	3	1-13/32	.444	4.8	3.3
14	E60P14H	P2	3.740	3.371	22	1-3/4	3 29/32	2-15/16	1-23/32	3	1-13/32	.444	4.8	3.3
15	E60P15H	P2	3.980	3.607	22	1-3/4	3 29/32	2-15/16	1-23/32	3	1-13/32	.444	5.5	4.0
16	E60P16H	P1	4.220	3.844	24	1-3/4	3 1/8	1-15/16	15/16	3	5/8	.444	4.7	3.4
17	E60Q17H	Q1	4.460	4.082	27	2-11/16	5	3-1/2	13/32	4-1/8	1-21/32	.444	8.1	4.6
18	E60Q18H	Q1	4.700	4.319	22	2-11/16	4-3/16	3-1/2	13/32	4-1/8	1-21/32	.444	8.5	5.0
19	E60Q19H	Q1	4.950	4.557	22	2-11/16	4-3/16	3-1/2	13/32	4-1/8	1-21/32	.444	9.4	5.9
20	E60Q20H	Q1	5.190	4.794	22	2-11/16	4-3/16	3-1/2	13/32	4-1/8	1-21/32	.444	10.5	7.0
21	E60Q21H	Q1	5.430	5.032	24	2-11/16	3-1/4	2-1/2	15/32	4-1/8	3/4	.444	9.2	5.7
22	E60Q22H	Q1	5.670	5.270	24	2-11/16	3-1/4	2-1/2	15/32	4-1/8	3/4	.444	10.1	6.6
23	E60Q23H	Q1	5.910	5.508	25	2-11/16	2-25/32	2-1/2	0	4-1/8	1/4	.444	11.2	7.7
24	E60Q24H	Q1	6.150	5.746	25	2-11/16	2-25/32	2-1/2	0	4-1/8	1/4	.444	12.3	8.8
25	E60Q25H	Q1	6.390	5.984	25	2-11/16	2-25/32	2-1/2	0	4-1/8	1/4	.444	13.5	10.0
26	E60Q26H	Q1	6.630	6.222	25	2-11/16	2-25/32	2-1/2	0	4-1/8	1/4	.444	14.6	11.1
27	E60Q27H	Q1	6.870	6.460	25	2-11/16	2-25/32	2-1/2	0	4-1/8	1/4	.444	15.9	12.4
28	E60Q28H	Q1	7.110	6.699	25	2-11/16	2-25/32	2-1/2	0	4-1/8	1/4	.444	17.1	13.6
30	E60R30H	R1	7.590	7.175	25	3-3/4	3-5/32	2-7/8	0	5-3/8	5/8	.444	21.5	14.0
32	E60R32H	R1	8.070	7.652	25	3-3/4	3-5/32	2-7/8	0	5-3/8	5/8	.444	26.5	19.0
35	E60R35H	R1	8.780	8.367	25	3-3/4	3-5/32	2-7/8	0	5-3/8	5/8	.444	29.5	22.0
36	E60R36H	R1	9.020	8.605	25	3-3/4	3-5/32	2-7/8	0	5-3/8	5/8	.444	30.9	23.4
40	E60R40	R1	9.980	9.559	25	3-3/4	3-5/32	2-7/8	0	5-3/8	5/8	.444	38.8	31.3
42	E60R42	R1	10.460	10.036	25	3-3/4	3-5/32	2-7/8	0	5-3/8	5/8	.444	42.8	35.3
52	E60R52	R1	12.850	12.422	25	3-3/4	3-5/32	2-7/8	0	5-3/8	5/8	.444	70.7	63.2

Sprockets with "H" suffix have hardened teeth.



All Steel Stock Sprockets

No. 80 1" Pitch

Single Type "BS" — 2 Setscrews — Bored-To-Size

No. Teeth	Catalog Number	Outside Diameter	Length Thru Bore	Weight Lbs. (Approx.)	Stock Finished Bores Includes Keyway and Setscrews														
9	80BS9	3.350	1%	1.6	1	—	1/4	—	1/8	—	1/4								
10	80BS10	3.680	1%	1.7	1	—	1/4	—	1/8	—	1/4								
10	80BS10W*	3.680	1%	1.7							1/4								
11	80BS11	4.010	1%	1.8	1	—	1/4	—	1/8	—	1/4	—	1/8	—	1/2	—	1/8		
11	80BS11W*	4.010	1%	1.8							1/4								
12	80BS12	4.330	1%	3.0	1	—	1/4	—	1/8	—	1/4	—	1/8	—	1/2	—	1/8	—	1/8
12	80BS12W*	4.330	1%	3.0							1/4								
13	80BS13	4.660	1%	3.5	1	—	1/4	—	1/8	—	1/4	—	1/8	—	1/2	—	1/8	—	1/8
14	80BS14	4.980	1 1/2	4.1	1	—	1/4	—	1/8	—	1/4	—	1/8	—	1/2	—	1/8	—	1/8
15	80BS15	5.300	1 1/2	5.2	1	—	1/4	—	1/8	—	1/4	—	1/8	—	1/2	—	1/8	—	1/8
15	80BS15W*	5.300	1 1/2	5.3							1/4								
16	80BS16	5.630	1 1/2	5.5	1	—	1/4	—	1/8	—	1/4	—	1/8	—	1/2	—	1/8	—	1/8
17	80BS17	5.950	1%	6.0	1	—	1/4	—	1/8	—	1/4	—	1/8	—	1/2	—	1/8	—	1/8
18	80BS18	6.270	1 1/2	6.5	1	—	1/4	—	1/8	—	1/4	—	1/8	—	1/2	—	1/8	—	1/8
18	80BS18W*	6.270	1 1/2	6.0	1/4	—	1/4	—	1/8	—	1/4								
19	80BS19	6.590	1 1/2	7.0	1	—	1/4	—	1/8	—	1/4	—	1/8	—	1/2	—	1/8	—	1/8
20	80BS20	6.910	1%	8.0	1	—	1/4	—	1/8	—	1/4	—	1/8	—	1/2	—	1/8	—	1/8
21	80BS21	7.240	1%	8.9	1	—	1/4	—	1/8	—	1/4	—	1/8	—	1/2	—	1/8	—	1/8
22	80BS22	7.560	1%	9.5	1	—	1/4	—	1/8	—	1/4	—	1/8	—	1/2	—	1/8	—	1/8
23	80BS23	7.880	1%	10.2	1	—	1/4	—	1/8	—	1/4	—	1/8	—	1/2	—	1/8	—	1/8
24	80BS24	8.200	1%	10.8	1	—	1/4	—	1/8	—	1/4	—	1/8	—	1/2	—	1/8	—	1/8
25	80BS25	8.520	1%	11.4	1	—	1/4	—	1/8	—	1/4	—	1/8	—	1/2	—	1/8	—	1/8
26	80BS26	8.840	2	14.0							1/4	—	1/8	—	1/2	—	1/8	—	1/8
27	80BS27	9.160	2	14.7							1/4	—	1/8	—	1/2	—	1/8	—	1/8
28	80BS28	9.480	2	15.3							1/4	—	1/8	—	1/2	—	1/8	—	1/8
29	80BS29	9.800	2	16.4							1/4	—	1/8	—	1/2	—	1/8	—	1/8
30	80BS30	10.110	2	16.7							1/4	—	1/8	—	1/2	—	1/8	—	1/8
31	80BS31	10.430	2	18.0							1/4	—	1/8	—	1/2	—	1/8	—	1/8
32	80BS32	10.750	2	18.8							1/4	—	1/8	—	1/2	—	1/8	—	1/8
33	80BS33	11.070	2	18.9							1/4	—	1/8	—	1/2	—	1/8	—	1/8
34	80BS34	11.390	2	20.6							1/4	—	1/8	—	1/2	—	1/8	—	1/8
35	80BS35	11.710	2	21.4							1/4	—	1/8	—	1/2	—	1/8	—	1/8
36	80BS36	12.030	2	22.4							1/4	—	1/8	—	1/2	—	1/8	—	1/8
37	80BS37	12.350	2	23.9							1/4	—	1/8	—	1/2	—	1/8	—	1/8
38	80BS38	12.670	2	24.0							1/4	—	1/8	—	1/2	—	1/8	—	1/8
39	80BS39	12.990	2	24.9							1/4	—	1/8	—	1/2	—	1/8	—	1/8
40	80BS40	13.310	2	26.0							1/4	—	1/8	—	1/2	—	1/8	—	1/8
41	80BS41	13.630	2	27.1							1/4	—	1/8	—	1/2	—	1/8	—	1/8
42	80BS42	13.940	2	28.0							1/4	—	1/8	—	1/2	—	1/8	—	1/8
43	80BS43	14.260	2	29.3							1/4	—	1/8	—	1/2	—	1/8	—	1/8
44	80BS44	14.580	2	29.3							1/4	—	1/8	—	1/2	—	1/8	—	1/8
45	80BS45	14.900	2	30.7							1/4	—	1/8	—	1/2	—	1/8	—	1/8
46	80BS46	15.220	2	32.4							1/4	—	1/8	—	1/2	—	1/8	—	1/8
47	80BS47	15.540	2	33.3							1/4	—	1/8	—	1/2	—	1/8	—	1/8
48	80BS48	15.860	2	34.8							1/4	—	1/8	—	1/2	—	1/8	—	1/8
49	80BS49	16.180	2	35.1							1/4	—	1/8	—	1/2	—	1/8	—	1/8
50	80BS50	16.500	2	36.6							1/4	—	1/8	—	1/2	—	1/8	—	1/8
51	80BS51	16.810	2	38.5							1/4	—	1/8	—	1/2	—	1/8	—	1/8
52	80BS52	17.130	2	40.3							1/4	—	1/8	—	1/2	—	1/8	—	1/8
53	80BS53	17.450	2	42.2							1/4	—	1/8	—	1/2	—	1/8	—	1/8
54	80BS54	17.770	2	44.0							1/4	—	1/8	—	1/2	—	1/8	—	1/8
55	80BS55	18.090	2	46.3							1/4	—	1/8	—	1/2	—	1/8	—	1/8
56	80BS56	18.410	2	47.3							1/4	—	1/8	—	1/2	—	1/8	—	1/8
57	80BS57	18.730	2	48.9							1/4	—	1/8	—	1/2	—	1/8	—	1/8
58	80BS58	19.040	2	50.6							1/4	—	1/8	—	1/2	—	1/8	—	1/8
59	80BS59	19.360	2	52.2							1/4	—	1/8	—	1/2	—	1/8	—	1/8
60	80BS60	19.680	2	58.8							1/4	—	1/8	—	1/2	—	1/8	—	1/8

Hub diameters vary to suit different bore sizes.

NOTE: KEYWAY IS ON CENTER LINE OF TOOTH

* W = Winch Sprockets — KW 5/16 x 3/32 — One S.S. at 90°

SPROCKETS

No. 80 1" Pitch

All Steel Stock Sprockets

Martin

Single Type "BS" Winch — 1 Setscrew

No. Teeth	Catalog Number	Outside Diameter	Length Thru Bore	Weight Lbs. (Approx.)	Stock Finished Bores Includes Keyway (see Footnote) and Set Screw at 90° from Keyway
10	80BS10W	3.680	1"	1.7	1 1/4
11	80BS11W	4.010	1"	1.8	1 1/4
12	80BS12W	4.330	1"	3.0	1 1/4
15	80BS15W	5.300	1 1/2"	5.2	1 1/4
18	80BS18W	6.270	1 1/2"	7.8	1 1/4 - 1 1/2"

NOTE: KEYWAY IS ON CENTER LINE OF TOOTH.

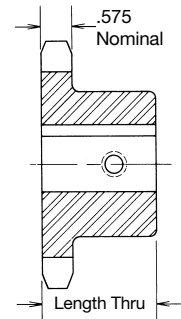

SINGLE TYPE BS

Double Type "BS" Winch (Hardened Teeth) — 1 Setscrew

No. Teeth	Catalog Number	Outside Diameter	Length Thru Bore	Weight Lbs. (Approx.)	Stock Finished Bores Includes Keyway (see Footnote) and Set Screw at 90° from Keyway
12	D80BS12HW	3.680	2 1/2"	5.2	1 1/4 - 1 1/2 - 1 1/4
15	D80BS15HW	5.300	2 1/2"	9.2	1 1/4 - 1 1/2 - 1 1/4
18	D80BS18HW	6.270	2 1/2"	13.5	1 1/2 - 1 1/4 - 2
20	D80BS20HW	6.910	2 1/2"	16.2	1 1/2 - 1 1/4 - 2
24	D80BS24HW	8.200	2 1/2"	23.2	1 1/2 - 2

NOTE: KEYWAY IS ON CENTER LINE OF TOOTH.

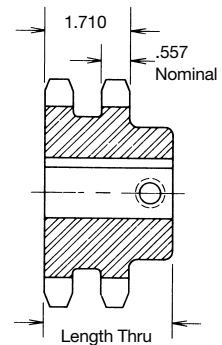

DOUBLE TYPE BS

Footnote: 1 1/4" bore has a 5/16" x 5/32" keyway
 1 1/2" bore has a 5/16" x 5/32" keyway
 1 3/4" bore has a 3/8" x 3/16" keyway
 2" bore has a 3/8" x 3/16" keyway



No. 80 — Hardened Teeth — 2 Setscrews

No. Teeth	Catalog Number	Outside Diameter	Length Thru Bore	Weight Lbs. (Approx.)	Stock Finished Bores Includes Keyway and 2 Setscrews
9	80BS9HT	3.350	1"	1.6	1 - 1 1/4 - 1 1/4 - 1 1/4
10	80BS10HT	3.368	1"	1.7	1 - 1 1/4 - 1 1/4 - 1 1/4
11	80BS11HT	4.010	1"	1.8	1 - 1 1/4 - 1 1/4 - 1 1/4 - 1 1/4 - 1 1/4 - 1 1/4 - 1 1/4
12	80BS12HT	4.330	1"	3.0	1 - 1 1/4 - 1 1/4 - 1 1/4 - 1 1/4 - 1 1/4 - 1 1/4 - 1 1/4 - 1 1/4
13	80BS13HT	4.660	1"	3.5	1 - 1 1/4 - 1 1/4 - 1 1/4 - 1 1/4 - 1 1/4 - 1 1/4 - 1 1/4 - 1 1/4 - 1 1/4 - 2
14	80BS14HT	4.980	1 1/2"	4.1	1 - 1 1/4 - 1 1/4 - 1 1/4 - 1 1/4 - 1 1/4 - 1 1/4 - 1 1/4 - 1 1/4 - 1 1/4 - 2
15	80BS15HT	5.300	1 1/2"	5.2	1 - 1 1/4 - 1 1/4 - 1 1/4 - 1 1/4 - 1 1/4 - 1 1/4 - 1 1/4 - 1 1/4 - 1 1/4 - 2
16	80BS16HT	5.630	1 1/2"	6.1	1 - 1 1/4 - 1 1/4 - 1 1/4 - 1 1/4 - 1 1/4 - 1 1/4 - 1 1/4 - 1 1/4 - 2
17	80BS17HT	5.950	1 1/2"	7.0	1 - 1 1/4 - 1 1/4 - 1 1/4 - 1 1/4 - 1 1/4 - 1 1/4 - 1 1/4 - 2 - 2 1/4
18	80BS18HT	6.270	1 1/2"	7.8	1 - 1 1/4 - 1 1/4 - 1 1/4 - 1 1/4 - 1 1/4 - 1 1/4 - 2 - 2 1/4
19	80BS19HT	6.590	1 1/2"	8.3	1 - 1 1/4 - 1 1/4 - 1 1/4 - 1 1/4 - 1 1/4 - 2 - 2 1/4
20	80BS20HT	6.910	1 1/2"	9.5	1 - 1 1/4 - 1 1/4 - 1 1/4 - 1 1/4 - 2 - 2 1/4

NOTE: KEYWAY IS ON CENTER LINE OF TOOTH

Martin stock hardened teeth sprockets afford longer chain and sprocket life. Hardened teeth on the smaller sprocket of a roller chain drive are recommended if the drive ratio is four to one or greater or if the smaller sprocket has 24 teeth or less and is running at a speed of over 600 R.P.M.

Single-Type C — Steel

No. Teeth	Catalog Number	Outside Diameter	Bore (inches)		Hub (inches)		Weight Lbs. (Approx.)
			Stock	Rec. Max.	Diameter	Length	
11	80C11	4.010	1	1 1/4	2 3/4*	2 1/2	3.87
12	80C12	4.330	1	1 1/4	3 1/2*	2 1/2	4.31
13	80C13	4.660	1	2	3 3/4	2 1/2	5.32
14	80C14	4.980	1	2 1/4	3 1/2	2 1/2	6.44
15	80C15	5.300	1	2 1/2	3 3/4	2 1/2	7.75
16	80C16	5.630	1	2 3/4	4	2 1/2	8.81

* Has recessed groove in hub for chain clearance.

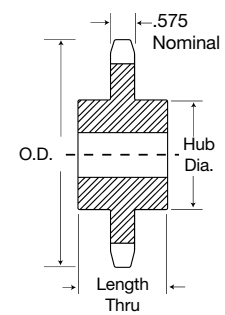

TYPE C

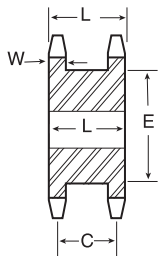

TYPE A

Double Single-Type A — Steel

No. Teeth	Catalog Number	Diameters		Type	Min. Bore	Max. Bore	Dimensions				Wt. (Approx.)
		Outside Diameter	Pitch Diameter				L	C	E	w Nom.	
13	DS80A13	4.660	4.179	A	1	2	2 ³ / ₁₆	1 ¹ / ₈	3 ¹ / ₄	.575	6.5
14	DS80A14	4.980	4.494	A	1	2 ¹ / ₂	2 ³ / ₁₆	1 ¹ / ₈	3 ¹ / ₂	.575	7.7
15	DS80A15	5.300	4.810	A	1	2 ³ / ₈	2 ³ / ₁₆	1 ¹ / ₈	3 ³ / ₁₆	.575	9.1
16	DS80A16	5.630	5.126	A	1	2 ¹ / ₂	2 ³ / ₁₆	1 ¹ / ₈	4	.575	9.5
17	DS80A17	5.950	5.442	A	1	2 ³ / ₈	2 ³ / ₁₆	1 ¹ / ₈	4 ¹ / ₈	.575	10.8
18	DS80A18	6.270	5.759	A	1	3 ¹ / ₈	2 ³ / ₁₆	1 ¹ / ₈	4 ¹ / ₄	.575	12.1
19	DS80A19	6.590	6.076	A	1	3 ¹ / ₂	2 ³ / ₁₆	1 ¹ / ₈	4 ⁵ / ₁₆	.575	12.8
20	DS80A20	6.910	6.392	A	1	3 ³ / ₈	2 ³ / ₁₆	1 ¹ / ₈	5 ¹ / ₂	.575	14.0
21	DS80A21	7.240	6.710	A	1	3 ¹ / ₂	2 ³ / ₁₆	1 ¹ / ₈	5 ³ / ₂	.575	16.5
22	DS80A22	7.560	7.027	A	1	3 ³ / ₈	2 ³ / ₁₆	1 ¹ / ₈	5 ⁵ / ₁₆	.575	18.4
23	DS80A23	7.880	7.344	A	1	3 ¹ / ₂	2 ³ / ₁₆	1 ¹ / ₈	6 ¹ / ₄	.575	20.5

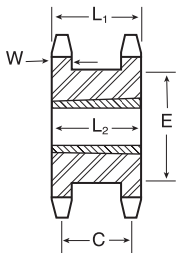

**TAPER BUSH
TYPE A**

Double Single-Taper Bushed — Steel

No. Teeth	Catalog Number	Bushing Size	Diameters		Min. Bore	Max. Bore	Type	Dimensions				Wt. Rim Only	
			Outside Diameter	Pitch Diameter				L ₁	C	E	L ₂		w Nom.
17	DS80ATB17H	2517	5.950	5.442	1/2	2 1/2	A	2 ³ / ₁₆	1 ¹ / ₈	4 ¹ / ₈	1 3/4	.575	7.6
18	DS80ATB18H	2517	6.270	5.759	1/2	2 1/2	A	2 ³ / ₁₆	1 ¹ / ₈	4 ¹ / ₄	1 3/4	.575	8.7
19	DS80ATB19H	3020	6.590	6.076	5/16	3	A	2 ³ / ₁₆	1 ¹ / ₈	4 ⁵ / ₁₆	2	.575	9.7
20	DS80ATB20H	3020	6.910	6.392	5/16	3	A	2 ³ / ₁₆	1 ¹ / ₈	5 ¹ / ₂	2	.575	10.0
21	DS80ATB21H	3020	7.240	6.710	5/16	3	A	2 ³ / ₁₆	1 ¹ / ₈	5 ³ / ₂	2	.575	12.0
22	DS80ATB22H	3020	7.560	7.027	5/16	3	A	2 ³ / ₁₆	1 ¹ / ₈	5 ⁵ / ₁₆	2	.575	13.0
23	DS80ATB23H	3020	7.880	7.344	5/16	3	A	2 ³ / ₁₆	1 ¹ / ₈	6 ¹ / ₄	2	.575	14.5

Sprockets with "H" suffix have hardened teeth.

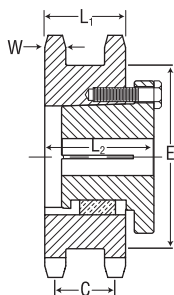

**MST
TYPE B**

Double Single- MST® — Steel

No. Teeth	Catalog Number	Bushing Size	Diameters		Min. Bore	Max. Bore	Type	Dimensions				Wt. Rim Only	
			Outside Diameter	Pitch Diameter				L ₁	C	E	L ₂		w Nom.
17	DS80Q17H	Q1	5.950	5.442	3/4	2 11/16	B	2 ³ / ₁₆	1 ¹ / ₈	4 ¹ / ₈	3 ¹ / ₄	.575	7.2
19	DS80Q19H	Q1	6.590	6.076	3/4	2 11/16	B	2 ³ / ₁₆	1 ¹ / ₈	4 ⁵ / ₁₆	3 ¹ / ₄	.575	10.5
20	DS80Q20H	Q1	6.910	6.392	3/4	2 11/16	B	2 ³ / ₁₆	1 ¹ / ₈	5 ¹ / ₂	3 ¹ / ₄	.575	12.2
21	DS80R21H	R1	7.240	6.710	1 ¹ / ₈	3 ³ / ₈	B	2 ³ / ₁₆	1 ¹ / ₈	5 ³ / ₂	3 ³ / ₄	.575	12.8
23	DS80R23H	R1	7.880	7.344	1 ¹ / ₈	3 ³ / ₈	B	2 ³ / ₁₆	1 ¹ / ₈	6 ¹ / ₄	3 ³ / ₄	.575	13.3

Sprockets with "H" suffix have hardened teeth.

No. 80 1" Pitch

Stainless Steel Stock Sprockets

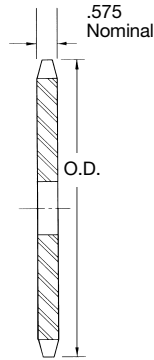

TYPE A

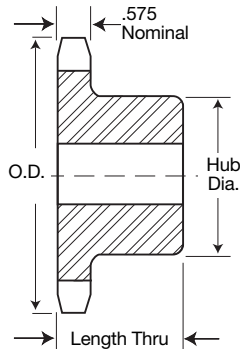

TYPE B

SPROCKETS

Single-Type B & C

Single-Type A

No. Teeth	Catalog Number	Outside Diameter	Type	Bore (inches)		Hub (inches)		Weight Lbs (Approx.)	Type	Catalog Number	Stock Bore	Weight Lbs. (Approx.)
				Stock	Rec. Max.	Dia.	Length Thru					
10	80B10SS	3.680	B	1	1½	2⅝★	1¾	2.2				
11	80B11SS	4.010	B	1	1¾	2⅞★	1¾	3.2				
12	80B12SS	4.330	B	1	1¾	3⅛★	1¾	3.4				
13	80B13SS	4.660	B	1	2	3	1½	3.5				
14	80B14SS	4.980	B	1	2¼	3¼	1½	4.1				
15	80B15SS	5.300	B	1	2½	3⅝	1½	5.3				
16	80B16SS	5.630	B	1	2¾	4	1½	5.9				
17	80B17SS	5.950	B	1	2¾	4	1½	6.6				
18	80B18SS	6.270	B	1	2¾	4¼	1½	7.3				
19	80B19SS	6.590	B	1	2¾	4¼	1½	7.8				
20	80B20SS	6.910	B	1	2¾	4¼	1½	8.4				
21	80B21SS	7.240	B	1	2¾	4¼	1¾	9.4	A	80A21SS	⅝	4.9
22	80B22SS	7.560	B	1	2¾	4¼	1¾	10.0	A	80A22SS	⅝	5.5
23	80B23SS	7.880	B	1	2¾	4¼	1¾	10.7	A	80A23SS	⅝	6.3
24	80B24SS	8.200	B	1	2¾	4¼	1¾	11.3	A	80A24SS	⅝	6.7
25	80B25SS	8.520	B	1	2¾	4¼	1¾	11.9	A	80A25SS	⅝	7.2
26	80B26SS	8.840	B	1¼	3¼	4¾	2	14.3	A	80A26SS	1⅝	7.8
30	80B30SS	10.110	B	1⅝	3¼	4¾	2	17.4	A	80A30SS	1⅝	10.7
35	80B35SS	11.710	B	1⅝	3¼	4¾	2	22.1	A	80A35SS	1⅝	14.8
40	80B40SS	13.310	B	1⅝	3¼	4¾	2	26.7	A	80A40SS	1⅝	18.9

★ Has recessed groove in hub for chain clearance.

Maximum bores shown will accommodate standard keyseat and setscrew over keyseat. Slightly larger bores are possible with no keyseat, shallow keyseat, or setscrew at angle to keyseat.

Single-Type B & C

Single-Type A

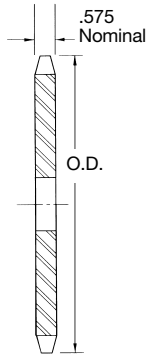

TYPE A

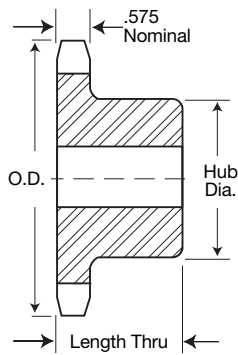

TYPE B

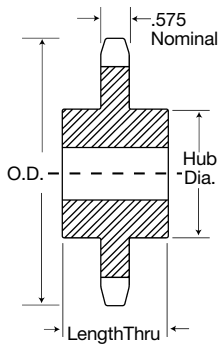

TYPE C

No. Teeth	Catalog Number	Outside Diameter	Type	Bore (inches)		Hub (inches)		Weight Lbs (Approx.)	Type	Catalog Number	Stock Bore	Weight Lbs. (Approx.)
				Stock	Rec. Max.	Dia.	Length Thru					
8	80B8	3.010	B	1	1	1 1/16*	1 1/8	1.4	A	80A9	1/16	.8
9	80B9	3.350	B	1	1 1/16	2 1/4*	1 1/8	1.6	A	80A10	1/16	1.0
10	80B10	3.680	B	1	1 1/2	2 3/8*	1 1/8	2.2	A	80A11	1/16	1.3
11	80B11	4.010	B	1	1 3/8	2 7/8*	1 1/8	3.2	A			
12	80B12	4.330	B	1	1 3/4	3 1/8*	1 1/8	3.4	A	80A12	1/16	1.5
13	80B13	4.660	B	1	2	3	1 1/8	3.5	A	80A13	1/16	1.8
14	80B14	4.980	B	1	2 1/4	3 1/2	1 1/8	4.1	A	80A14	1/16	2.2
15	80B15	5.300	B	1	2 1/2	3 3/8	1 1/8	5.3	A	80A15	1/16	2.5
16	80B16	5.630	B	1	2 3/4	4	1 1/8	5.9	A	80A16	1/16	2.9
17	80B17	5.950	B	1	2 3/4	4	1 1/2	6.6	A	80A17	1/16	3.3
18	80B18	6.270	B	1	2 3/4	4 1/4	1 1/8	7.3	A	80A18	1/16	3.7
19	80B19	6.590	B	1	2 3/4	4 1/4	1 1/2	7.8	A	80A19	1/16	4.1
20	80B20	6.910	B	1	2 3/4	4 1/2	1 1/8	8.4	A	80A20	1/16	4.7
21	80B21	7.240	B	1	2 3/4	4 1/2	1 1/4	9.4	A	80A21	1/16	4.9
22	80B22	7.560	B	1	2 3/4	4 1/2	1 1/2	10.0	A	80A22	1/16	5.5
23	80B23	7.880	B	1	2 3/4	4 1/2	1 3/4	10.7	A	80A23	1/16	6.3
24	80B24	8.200	B	1	2 3/4	4 1/2	1 3/4	11.3	A	80A24	1/16	6.7
25	80B25	8.520	B	1	2 3/4	4 1/2	1 3/4	11.9	A	80A25	1/16	7.2
26	80B26	8.840	B	1 1/4	3 1/4	4 1/2	2	14.3	A	80A26	1/16	7.8
27	80B27	9.160	B	1 1/4	3 1/4	4 1/2	2	15.4	A	80A27	1/16	8.6
28	80B28	9.480	B	1 1/4	3 1/4	4 1/2	2	16.0	A	80A28	1/16	9.3
29	80B29	9.800	B	1 1/4	3 1/4	4 1/2	2	17.1	A	80A29	1/16	9.8
30	80B30	10.110	B	1 1/4	3 1/4	4 1/2	2	17.4	A	80A30	1/16	10.7
31	80B31	10.430	B	1 1/4	3 1/4	4 1/2	2	18.7	A	80A31	1/16	11.3
32	80B32	10.750	B	1 1/4	3 1/4	4 1/2	2	19.5	A	80A32	1/16	12.1
33	80B33	11.070	B	1 1/4	3 1/4	4 1/2	2	19.6	A	80A33	1/16	13.6
34	80B34	11.390	B	1 1/4	3 1/4	4 1/2	2	21.3	A	80A34	1/16	14.3
35	80B35	11.710	B	1 1/4	3 1/4	4 1/2	2	22.1	A	80A35	1/16	14.8
36	80B36	12.030	B	1 1/4	3 1/4	4 1/2	2	23.1	A	80A36	1/16	16.1
37	80B37	12.350	B	1 1/4	3 1/4	4 1/2	2	23.8	A	80A37	1/16	16.8
38	80B38	12.670	B	1 1/4	3 1/4	4 1/2	2	24.7	A	80A38	1/16	17.2
39	80B39	12.990	B	1 1/4	3 1/4	4 1/2	2	25.6	A	80A39	1/16	17.9
40	80B40	13.310	B	1 1/4	3 1/4	4 1/2	2	26.7	A	80A40	1/16	18.9
41	80B41	13.630	B	1 1/4	3 1/4	4 1/2	2	27.8	A	80A41	1/16	21.0
42	80B42	13.940	B	1 1/4	3 1/4	4 1/2	2	28.7	A	80A42	1/16	21.8
43	80B43	14.260	B	1 1/4	3 1/4	4 1/2	2	29.4	A	80A43	1/16	23.6
44	80B44	14.580	B	1 1/4	3 1/4	4 1/2	2	29.9	A	80A44	1/16	24.3
45	80B45	14.900	B	1 1/4	3 1/4	4 1/2	2	31.4	A	80A45	1/16	25.2
46	80B46	15.220	B	1 1/4	3 1/4	4 1/2	2	33.1	A	80A46	1/16	26.6
47	80B47	15.540	B	1 1/4	3 1/4	4 1/2	2	34.0	A	80A47	1/16	26.4
48	80B48	15.860	B	1 1/4	3 1/4	4 1/2	2	35.5	A	80A48	1/16	27.8
49	80B49	16.180	B	1 1/4	3 1/4	4 1/2	2	35.8	A	80A49	1/16	28.9
50	80B50	16.500	B	1 1/4	3 1/4	4 1/2	2	37.3	A	80A50	1/16	30.9
51	80B51	16.810	B	1 1/4	3 1/4	4 1/2	2	38.6	A	80A51	1/16	32.2
52	80B52	17.130	B	1 1/4	3 1/4	4 1/2	2	39.4	A	80A52	1/16	33.0
53	80B53	17.450	B	1 1/4	3 1/4	4 1/2	2	41.3	A	80A53	1/16	34.9
54	80B54	17.770	B	1 1/4	3 1/2	5 1/2	2	44.7	A	80A54	1/16	36.6
55	80B55	18.090	B	1 1/4	3 1/2	5 1/2	2	45.6	A	80A55	1/16	37.5
56	80B56	18.410	B	1 1/4	3 1/2	5 1/2	2	47.5	A	80A56	1/16	39.4
57	80B57	18.730	B	1 1/4	3 1/2	5 1/2	2	48.5	A	80A57	1/16	40.4
58	80B58	19.040	B	1 1/4	3 1/2	5 1/2	2	50.5	A	80A58	1/16	41.3
59	80B59	19.360	B	1 1/4	3 1/2	5 1/2	2	52.1	A	80A59	1/16	42.9
60	80B60	19.680	B	1 1/4	3 1/2	5 1/2	2	54.5	A	80A60	1/16	45.3
65	80B65	21.270	B	1 1/4	3 1/2	5 1/2	2	61.8	A	80A65	1/16	52.2
70	80C70	22.870	C	1 1/2	4 1/4	6 1/4	3 1/8	75.7	A	80A70	1/16	59.8
72	80C72	23.500	C	1 1/2	4 1/4	6 1/4	3 1/8	81.4	A	80A72	1/16	65.7
76	80C76	24.780	C	1 1/2	4 1/4	6 1/4	3 1/8	87.8	A	80A76	1/16	70.2
80	80C80	26.050	C	1 1/2	4 1/4	6 1/4	3 1/8	89.9	A	80A80	1/16	79.6
84	80C84	27.330	C	1 1/2	4 1/4	6 1/4	3 1/8	99.2	A	80A84	1/16	86.1
90	80C90	29.240	C	1 1/2	4 1/4	6 1/4	3 1/8	106	A	80A90	1/16	101
96	80C96	31.150	C	1 1/2	4 1/4	6 1/4	3 1/8	117	A	80A96	1/16	120
112	80C112	36.240	C	1 1/2	4 1/4	6 1/4	3 1/8	154	A	80A112	1/16	165

* Has recessed groove in hub for chain clearance.

Maximum bores shown will accommodate standard keyseat and setscrew over keyseat. Slightly larger bores are possible with no keyseat, shallow keyseat, or setscrew at angle to keyseat.

SPROCKETS

No. 80 1" Pitch

All Steel Stock Sprockets

Martin

Single-Type QD With Hardened Teeth

No. Teeth	Catalog Number
11	80SH11H
12	80SH12H
13	80SDS13H
14	80SDS14H
15	80SK15H
16	80SK16H
17	80SK17H
18	80SK18H
19	80SK19H
20	80SF20H
21	80SF21H
22	80SF22H
23	80SF23H
24	80SF24H
25	80SF25H
26	80SF26H
27	80SF27H
28	80SF28H
30	80SF30H

**SABER
TOOTH®**

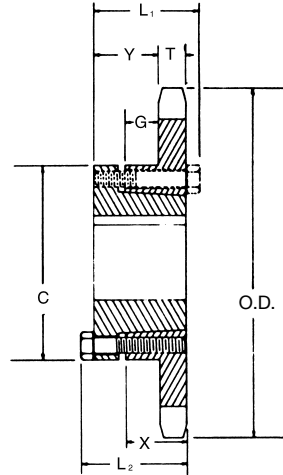

QD — TYPE B

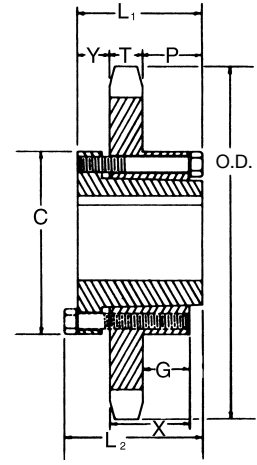

QD — TYPE C

Single-Type QD

No. Teeth	Catalog Number	Bushing	Diameters		Type	Max. Bore	Dimensions								Weight (Approx.)	
			Outside Diameter	Pitch Diameter			L ₁	L ₂	C	Y	P	G	X	T	With Hub	Rim Only
11	80SH11	SH	4.010	3.550	B	1%	1 ¹ / ₁₆	1 ¹ / ₁₆	2 ¹ / ₁₆	2 ¹ / ₃₂		1 ¹ / ₁₆	1 ¹ / ₁₆	.575	2.0	1.0
12	80SH12	SH	4.330	3.864	B	1%	1 ¹ / ₁₆	1 ¹ / ₁₆	2 ¹ / ₁₆	2 ¹ / ₃₂		1 ¹ / ₁₆	1 ¹ / ₁₆	.575	2.4	1.4
13	80SDS13	SDS	4.660	4.179	B	2	1 ¹ / ₂	1 ¹ / ₂	3 ³ / ₁₆	4 ⁷ / ₆₄		1 ¹ / ₁₆	3 ¹ / ₄	.575	2.5	1.5
14	80SDS14	SDS	4.980	4.494	B	2	1 ¹ / ₂	1 ¹ / ₂	3 ³ / ₁₆	4 ⁷ / ₆₄		1 ¹ / ₁₆	3 ¹ / ₄	.575	2.8	1.8
15	80SK15	SK	5.300	4.810	B	2%	2%	2%	3%	1 ¹ / ₁₆				.575	4.5	2.5
16	80SK16	SK	5.630	5.126	B										5.1	3.1
17	80SK17	SK	5.950	5.442	B										5.5	3.5
18	80SK18	SK	6.270	5.759	B										5.9	3.9
19	80SK19	SK	6.590	6.076	B	2%	2%	2%	3%	1 ¹ / ₁₆				.575	6.4	4.4
20	80SF20	SF	6.910	6.392	B	2 ¹ / ₁₆	2 ¹ / ₄	2 ¹ / ₄	4%	1 ¹ / ₁₆				.575	8.3	5.3
21	80SF21	SF	7.240	6.710	B										8.7	5.7
22	80SF22	SF	7.560	7.027	B										9.3	6.3
23	80SF23	SF	7.880	7.344	B										9.8	6.8
24	80SF24	SF	8.200	7.661	B										10.5	7.5
25	80SF25	SF	8.520	7.979	B										11.0	8.0
26	80SF26	SF	8.840	8.296	B										11.6	8.6
27	80SF27	SF	9.160	8.614	B										12.4	9.4
28	80SF28	SF	9.480	8.931	B										13.2	10.2
30	80SF30	SF	10.110	9.567	B										14.3	11.3
32	80SF32	SF	10.750	10.202	B										16.0	13.0
33	80SF33	SF	11.070	10.520	B										16.5	13.5
34	80SF34	SF	11.390	10.838	B										17.1	14.1
35	80SF35	SF	11.710	11.156	B										18.5	15.5
36	80SF36	SF	12.030	11.474	B										19.9	16.9
40	80SF40	SF	13.310	12.746	B										23.6	20.6
42	80SF42	SF	13.940	13.382	B										25.4	22.4
45	80SF45	SF	14.900	14.336	B										28.1	25.1
48	80SF48	SF	15.860	15.290	B										31.6	28.6
54	80SF54	SF	17.770	17.198	B										39.8	36.8
60	80SF60	SF	19.680	19.107	B	2 ¹ / ₁₆	2%	2%	4%	1 ¹ / ₁₆				.575	48.8	45.8
70	80E70	E	22.870	22.289	C	3%	2%	2 ¹ / ₁₆	6	7 ¹ / ₁₆	1 ¹ / ₁₆	1 ¹ / ₁₆	1%	.575	65.6	55.6
72	80E72	E	23.500	22.926	C										69.3	59.3
80	80E80	E	26.050	25.471	C										79.2	69.2
84	80E84	E	27.330	26.744	C										84.9	74.9
96	80E96	E	31.150	30.563	C	3%	2%	2 ¹ / ₁₆	6	7 ¹ / ₁₆	1 ¹ / ₁₆	1 ¹ / ₁₆	1%	.575	108	97.5
112	80F112	F	36.240	35.655	C	3 ¹ / ₁₆	3%	4	6%	1	2 ¹ / ₁₆	1 ¹ / ₁₆	2%	.575	145	134

SABER
TOOTH®

Single-Taper Bushed with Hardened Teeth

No. Teeth	Catalog Number
10	80BTB10H
11	80BTB11H
12	80BTB12H
13	80BTB13H
14	80BTB14H
15	80BTB15H
16	80BTB16H
17	80BTB17H
18	80BTB18H
19	80BTB19H
20	80BTB20H
21	80BTB21H
22	80BTB22H
23	80BTB23H
24	80BTB24H
25	80BTB25H
26	80BTB26H
27	80BTB27H
28	80BTB28H
30	80BTB30H

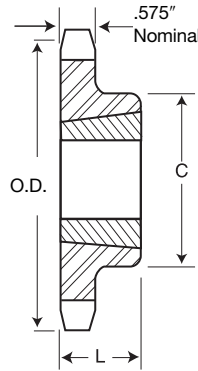

TYPE B

SPROCKETS

Single-Taper Bushed

No. Teeth	Catalog Number	Bushing	Diameter		Max. Bore	Dimensions		Type	Weight (Approx.)	
			Outside Diameter	Pitch Diameter		L	C		Rim Only	Bushing Only
10	80BTB10	1215	3.678	3.236	1 1/2	1 1/2	2 3/8*	B	1.1	.8
11	80BTB11	1215	4.006	3.549	1 1/2	1 1/2	2 1/2*	B	1.5	.8
12	80BTB12	1615	4.332	3.864	1 1/2	1 1/2	3*	B	1.8	1.2
13	80BTB13	1615	4.657	4.179	1 1/2	1 1/2	3	B	2.3	1.2
14	80BTB14	1615	4.982	4.494	1 1/2	1 1/2	3 1/2	B	2.5	1.2
15	80BTB15	1615	5.305	4.810	1 1/2	1 1/2	3 1/2	B	2.7	1.2
16	80BTB16	2012	5.627	5.126	2	1 1/2	4	B	2.8	1.7
17	80BTB17	2012	5.950	5.442	2	1 1/2	4	B	3.1	1.7
18	80BTB18	2012	6.271	5.759	2	1 1/2	3 5/8	B	2.6	1.7
19	80BTB19	2012	6.593	6.076	2	1 1/2	3 5/8	B	4.1	1.7
20	80BTB20	2517	6.914	6.392	2 1/2	1 1/2	4 1/2	B	5.5	1.7
21	80BTB21	2517	7.235	6.710	2 1/2	1 1/2	4 1/2	B	6.0	3.5
22	80BTB22	2517	7.555	7.027	2 1/2	1 1/2	4 1/2	B	6.5	3.5
23	80BTB23	2517	7.875	7.344	2 1/2	1 1/2	4 1/2	B	7.0	3.5
24	80BTB24	2517	8.196	7.661	2 1/2	1 1/2	4 1/2	B	7.5	3.5
25	80BTB25	2517	8.516	7.979	2 1/2	1 1/2	4 1/2	B	8.1	3.5
26	80BTB26	2517	8.836	8.296	2 1/2	1 1/2	4 1/2	B	8.8	3.5
27	80BTB27	2517	9.156	8.614	2 1/2	1 1/2	4 1/2	B	9.0	3.5
28	80BTB28	2517	9.475	8.931	2 1/2	1 1/2	4 1/2	B	9.5	3.5
30	80BTB30	2517	10.114	9.567	2 1/2	1 1/2	4 1/2	B	11.5	3.5
32	80BTB32	2517	10.753	10.202	2 1/2	1 1/2	4 1/2	B	12.0	3.5
35	80BTB35	2517	11.711	11.156	2 1/2	1 1/2	4 1/2	B	15.2	3.5
36	80BTB36	2517	12.030	11.474	2 1/2	1 1/2	4 1/2	B	17.0	3.5
40	80BTB40	2517	13.306	12.746	2 1/2	1 1/2	4 1/2	B	21.0	3.5
45	80BTB45	2517	14.901	14.336	2 1/2	1 1/2	4 1/2	B	26.5	3.5
48	80BTB48	2517	15.857	15.290	2 1/2	1 1/2	4 1/2	B	29.5	3.5
54	80BTB54	2517	17.769	17.198	2 1/2	1 1/2	4 1/2	B	38.5	3.5
60	80BTB60	2517	19.681	19.107	2 1/2	1 1/2	4 1/2	B	45.0	3.5
70	80BTB70	3020	22.867	22.289	3	2	5 1/2	B	52.3	6.5
80	80BTB80	3020	26.052	25.471	3	2	5 1/2	B	69.2	6.5

* Has recessed groove in hub for chain clearance.

No. 80 1" Pitch

MST® Sprockets

Martin

Single - MST® Sprockets

No. Teeth	Catalog Number	Bush-ing	Diameters		Type	Max. Bore	Dimensions						Weight (Approx.)	
			Outside Dia.	Pitch Dia.			OL	L	C	H	P	T(nom)	With Hub	Rim Only
10	80H10H	H	3.680	3.236	3	1-1/2	2-3/32	11/4	21/32	2-1/2	1-21/64	.575	2.8	2.0
11	80H11H	H	4.010	3.550	3	1-1/2	1-1/2	1-1/4	1/16	2-1/2	3/4	.575	2.1	1.3
11	80P11H	P	4.010	3.550	4	1-3/4	2-11/32	1-15/16	5/32	3	1-17/32	.575	2.4	1.6
12	80P12H	P1	4.330	3.864	4	1-3/4	2-3/16	1-15/16	0	3	1-3/8	.575	3.3	2.0
13	80P13H	P1	4.660	4.179	4	1-3/4	2-3/16	1-15/16	0	3	1-3/8	.575	3.7	2.4
14	80P14H	P1	4.980	4.494	4	1-3/4	2-3/16	1-15/16	0	3	1-3/8	.575	3.9	2.6
14	80Q14H	Q1	4.980	4.494	4	2-11/16	2-25/32	2-1/2	0	4-1/8	1-15/16	.575	6.4	2.9
15	80P15H	P1	5.300	4.810	4	1-3/4	2-3/16	1-15/16	0	3	1-3/8	.575	4.3	3.0
15	80Q15H	Q1	5.300	4.810	4	2-11/16	2-25/32	2-1/2	0	4-1/8	1-15/16	.575	6.9	3.4
16	80P16H	P1	5.630	5.126	4	1-3/4	2-3/16	1-15/16	0	3	1-3/8	.575	4.8	3.5
16	80Q16H	Q1	5.630	5.126	4	2-11/16	2-25/32	2-1/2	0	4-1/8	1-15/16	.575	8.1	4.6
17	80P17H	P1	5.950	5.442	4	1-3/4	2-3/16	1-15/16	0	3	1-3/8	.575	5.1	3.8
17	80Q17H	Q1	5.950	5.442	4	2-11/16	2-25/32	2-1/2	0	4-1/8	1-15/16	.575	8.8	5.3
18	80P18H	P1	6.270	5.759	4	1-3/4	2-3/16	1-15/16	0	3	1-3/8	.575	5.7	4.4
18	80Q18H	Q1	6.270	5.759	4	2-11/16	2-25/32	2-1/2	0	4-1/8	1-15/16	.575	9.5	6.0
19	80P19H	P1	6.590	6.076	4	1-3/4	2-3/16	1-15/16	0	3	1-3/8	.575	6.2	4.9
19	80Q19H	Q1	6.590	6.076	4	2-11/16	2-25/32	2-1/2	0	4-1/8	1-15/16	.575	10.0	6.5
20	80Q20H	Q1	6.910	6.392	4	2-11/16	2-25/32	2-1/2	0	4-1/8	1-15/16	.575	10.5	7.0
21	80Q21H	Q1	7.240	6.710	4	2-11/16	2-25/32	2-1/2	0	4-1/8	1-15/16	.575	10.8	7.3
22	80Q22H	Q1	7.560	7.027	4	2-11/16	2-25/32	2-1/2	0	4-1/8	1-15/16	.575	11.7	8.2
23	80Q23H	Q1	7.880	7.344	4	2-11/16	2-25/32	2-1/2	0	4-1/8	1-15/16	.575	12.3	8.8
24	80Q24H	Q1	8.200	7.661	4	2-11/16	2-25/32	2-1/2	0	4-1/8	1-15/16	.575	12.6	9.1
25	80Q25H	Q1	8.520	7.979	4	2-11/16	2-25/32	2-1/2	0	4-1/8	1-15/16	.575	13.1	9.6
26	80Q26H	Q1	8.840	8.296	4	2-11/16	2-25/32	2-1/2	0	4-1/8	1-15/16	.575	14.1	10.6
27	80Q27H	Q1	9.160	8.614	4	2-11/16	2-25/32	2-1/2	0	4-1/8	1-15/16	.575	14.4	10.9
28	80Q28H	Q1	9.480	8.931	4	2-11/16	2-25/32	2-1/2	0	4-1/8	1-15/16	.575	15.9	12.4
29	80Q29H	Q1	9.800	9.249	4	2-11/16	2-25/32	2-1/2	0	4-1/8	1-15/16	.575	16.1	12.6
30	80Q30H	Q1	10.110	9.567	4	2-11/16	2-25/32	2-1/2	0	4-1/8	1-15/16	.575	16.9	13.4
31	80Q31	Q1	10.430	9.885	4	2-11/16	2-25/32	2-1/2	0	4-1/8	1-15/16	.575	17.4	13.9
32	80Q32	Q1	10.750	10.202	4	2-11/16	2-25/32	2-1/2	0	4-1/8	1-15/16	.575	18.3	14.8
33	80Q33	Q1	11.070	10.520	4	2-11/16	2-25/32	2-1/2	0	4-1/8	1-15/16	.575	19.0	15.5
34	80Q34	Q1	11.390	10.838	4	2-11/16	2-25/32	2-1/2	0	4-1/8	1-15/16	.575	19.8	16.3
35	80Q35	Q1	11.710	11.156	4	2-11/16	2-25/32	2-1/2	0	4-1/8	1-15/16	.575	21.3	17.8
36	80Q36	Q1	12.030	11.474	4	2-11/16	2-25/32	2-1/2	0	4-1/8	1-15/16	.575	21.6	18.1
36	80R36	R1	12.030	11.474	4	3-3/4	3-5/32	2-7/8	0	5-3/8	2 5/16	.575	27.0	19.5
37	80Q37	Q1	12.350	11.792	4	2-11/16	2-25/32	2-1/2	0	4-1/8	1-15/16	.575	22.0	18.5
38	80Q38	Q1	12.670	12.110	4	2-11/16	2-25/32	2-1/2	0	4-1/8	1-15/16	.575	23.5	20.0
39	80R39	R1	12.990	12.428	4	3-3/4	3-5/32	2-7/8	0	5-3/8	2 5/16	.575	30.3	22.8
40	80Q40	Q1	13.310	12.746	4	2-11/16	2-25/32	2-1/2	0	4-1/8	1-15/16	.575	25.4	21.9
40	80R40	R1	13.310	12.746	4	3-3/4	3-5/32	2-7/8	0	5-3/8	2 5/16	.575	30.9	23.4
41	80R41	R1	13.630	13.064	4	3-3/4	3-5/32	2-7/8	0	5-3/8	2 5/16	.575	31.4	23.9
42	80Q42	Q1	13.940	13.382	4	2-11/16	2-25/32	2-1/2	0	4-1/8	1-15/16	.575	27.3	23.8
42	80R42	R1	13.940	13.382	4	3-3/4	3-5/32	2-7/8	0	5-3/8	2 5/16	.575	32.9	25.4
44	80R44	R1	14.580	14.018	4	3-3/4	3-5/32	2-7/8	0	5-3/8	2 5/16	.575	34.7	27.2
45	80Q45	Q1	14.900	14.336	4	2-11/16	2-25/32	2-1/2	0	4-1/8	1-15/16	.575	31.3	27.8
45	80R45	R1	14.900	14.336	4	3-3/4	3-5/32	2-7/8	0	5-3/8	2 5/16	.575	36.0	28.5
47	80R47	R1	15.540	14.972	4	3-3/4	3-5/32	2-7/8	0	5-3/8	2 5/16	.575	38.5	31.0
48	80Q48	Q1	15.860	15.290	4	2-11/16	2-25/32	2-1/2	0	4-1/8	1-15/16	.575	34.3	30.8
48	80R48	R1	15.860	15.290	4	3-3/4	3-5/32	2-7/8	0	5-3/8	2 5/16	.575	39.8	32.3
50	80R50	R1	16.500	15.926	4	3-3/4	3-5/32	2-7/8	0	5-3/8	2 5/16	.575	42.6	35.1
54	80Q54	Q1	17.770	17.198	4	2-11/16	2-25/32	2-1/2	0	4-1/8	1-15/16	.575	42.0	38.5
54	80R54	R1	17.770	17.198	4	3-3/4	3-5/32	2-7/8	0	5-3/8	2 5/16	.575	48.3	40.8
56	80R56	R1	18.410	17.835	4	3-3/4	3-5/32	2-7/8	0	5-3/8	2 5/16	.575	51.5	44.0
60	80Q60	Q1	19.680	19.107	4	2-11/16	2-25/32	2-1/2	0	4-1/8	1-15/16	.575	50.3	46.8
60	80R60	R1	19.680	19.107	4	3-3/4	3-5/32	2-7/8	0	5-3/8	2 5/16	.575	54.8	47.3
70	80Q70	Q1	22.870	22.289	4	2-11/16	2-25/32	2-1/2	0	4-1/8	2 5/16	.575	63.5	60.0
70	80R70	R1	22.870	22.289	4	3-3/4	3-5/32	2-7/8	0	5-3/8	2 5/16	.575	71.0	63.5
72	80Q72	Q1	23.500	22.926	4	2-11/16	2-25/32	2-1/2	0	4-1/8	2 5/16	.575	71.0	67.5
72	80R72	R1	23.500	22.926	5	3-3/4	3-5/32	2-7/8	1-7/16	5-3/8	7/8	.575	76.9	69.4
80	80R80	R1	26.050	25.471	5	3-3/4	3-5/32	2-7/8	1-7/16	5-3/8	7/8	.575	92.5	85.0
84	80R84	R1	27.330	26.744	5	3-3/4	3-5/32	2-7/8	1-7/16	5-3/8	7/8	.575	97.5	90.0
96	80R96	R1	31.150	30.563	5	3-3/4	3-5/32	2-7/8	1-7/16	5-3/8	7/8	.575	117.5	110.0
112	80S112	S1	36.240	36.655	5	4-1/4	4-3/4	4-3/8	2 3/4	6-3/8	1-1/8	.575	178.5	165.0

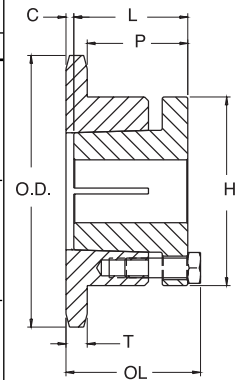

TYPE 3

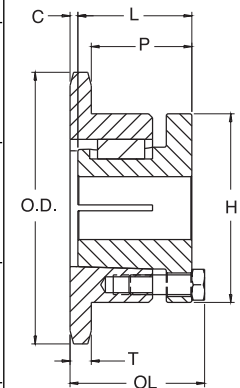

TYPE 4

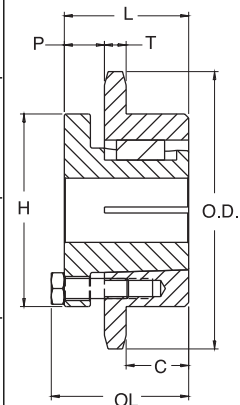

TYPE 5

Sprockets with "H" suffix have hardened teeth.

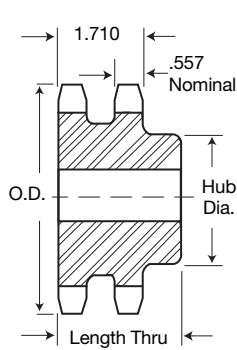

TYPE B

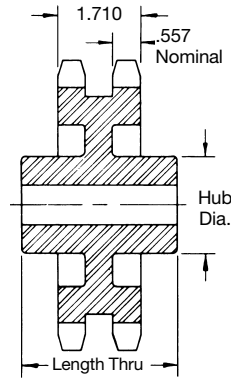

TYPE C

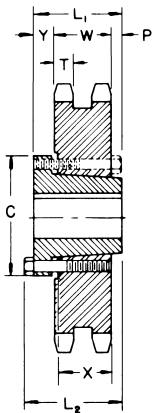

QD — TYPE C₁

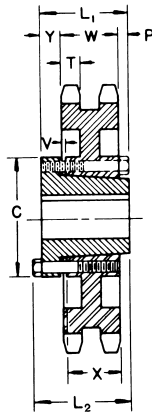

QD — TYPE C₃

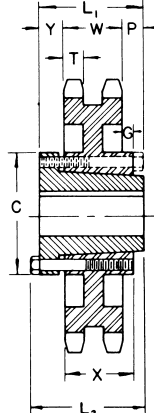

QD — TYPE C₄

Double-Type B & C

No. Teeth	Catalog Number	Outside Diameter	Type	Bore (inches)		Hub (inches)		Weight Lbs. (Approx.)
				Stock	Rec. Max.	Dia.	Length Thru	
10	D80B10H	3.680	B	1	1 1/2	2 3/8*	2 3/8	3.6
11	D80B11H	4.010	B	1	1 1/2	2 1/2	2 1/2	4.0
12	D80B12H	4.330	B	1	1 1/2	2 3/8	2 1/2	5.1
13	D80B13H	4.660	B	1	2 1/4	3 1/2	2 1/2	6.3
14	D80B14H	4.980	B	1	2 1/2	3 3/8	2 1/2	7.6
15	D80B15H	5.300	B	1	2 1/2	3 3/8	2 1/2	9.0
16	D80B16H	5.630	B	1	2 3/4	4	2 1/2	11.0
17	D80B17H	5.950	B	1	3	4 1/4	2 1/2	13.2
18	D80B18H	6.270	B	1	3 1/4	4 3/8	2 1/2	15.0
19	D80B19H	6.590	B	1	3 3/8	5	2 1/2	17.0
20	D80B20H	6.910	B	1	3 3/8	5	2 1/2	18.2
21	D80B21H	7.240	B	1	3 3/8	5	2 1/2	19.6
22	D80B22H	7.560	B	1	3 3/8	5	2 1/2	21.0
23	D80B23H	7.880	B	1	3 3/8	5	2 1/2	22.8
24	D80B24H	8.200	B	1	3 1/2	5 1/2	2 1/2	25.1
25	D80B25H	8.520	B	1	3 1/2	5 1/2	3	28.3
26	D80B26	8.840	B	1	3 1/2	5 1/2	3	29.9
30	D80B30	10.110	B	1 1/4	3 3/4	5 3/4	3	39.5
32	D80B32	10.750	B	1 1/4	3 3/4	5 3/4	3	43.8
35	D80B35	11.710	B	1 1/4	3 3/4	5 3/4	3	49.1
36	D80B36	12.030	B	1 1/4	3 3/4	5 3/4	3 3/8	54.2
42	D80B42	13.940	B	1 1/4	3 3/4	5 3/4	3 3/8	71.5
45	D80B45	14.900	B	1 1/4	3 3/4	5 3/4	3 3/8	73.5
52	D80C52	17.130	C	1 1/2	3 3/4	5 3/4	3 3/4	78.4
60	D80C60	19.680	C	1 1/2	3 3/4	5 3/4	3 3/4	93.3
68	D80C68	22.230	C	1 1/2	3 3/8	6	4	96.2
76	D80C76	24.780	C	1 1/2	3 3/8	6	4	113
95	D80C95	30.830	C	1 1/2	4	6	4 1/2	165

* Has recessed groove in hub for chain clearance.

Maximum bores shown will accommodate standard keyseat and setscrew over keyseat. Slightly larger bores are possible with no keyseat, shallow keyseat, or setscrew at angle to keyseat.

NOTE: Double 80 stock sprockets with 25 teeth or less have hardened teeth. As indicated by H suffix.

Alteration Charges

See current discount sheet for alteration charges.

Double-Type QD

No. Teeth	Catalog Number	Bush-ing	Diameters		Type	Max. Bore	Dimensions								Weight (Approx.)			
			Outside Diameter	Pitch Diameter			L ₁	L ₂	C	Y	P	G	V	X	T	W	With Hub	Rim Only
36	D80E36	E	12.030	11.474	C1	3 1/2	2 1/2	2 15/16	6	5/16	1/8			1 1/8	.557	1.710	48.3	38.2
42	D80E42	E	13.940	13.382	C1	3 1/2	2 1/2	2 15/16	6	5/16	1/8			1 1/8	.557	1.710	65.3	55.3
45	D80E45	E	14.900	14.336	C1	3 1/2	2 1/2	2 15/16	6	5/16	1/8			1 1/8	.557	1.710	74.6	64.6
52	D80E52	E	17.130	16.562	C3	3 1/2	2 1/2	2 15/16	6	5/16	1/8		3/32	1 1/8	.557	1.710	68.2	58.2
60	D80E60	E	19.680	19.107	C3	3 1/2	2 1/2	2 15/16	6	5/16	1/8		3/32	1 1/8	.557	1.710	78.2	68.2
68	D80E68	E	22.230	21.653	C3	3 1/2	2 1/2	2 15/16	6	5/16	1/8		3/32	1 1/8	.557	1.710	84.2	74.2
76	D80E76	E	24.780	24.198	C3	3 1/2	2 1/2	2 15/16	6	5/16	1/8		3/32	1 1/8	.557	1.710	100	90.1
95	D80F95	F	30.830	30.245	C4	3 15/16	3 1/2	4	6 1/2	1	59/64	5/64		2 1/2	.557	1.710	152	140

No. 80-2 1" Pitch

All Steel Stock Sprockets

SPROCKETS

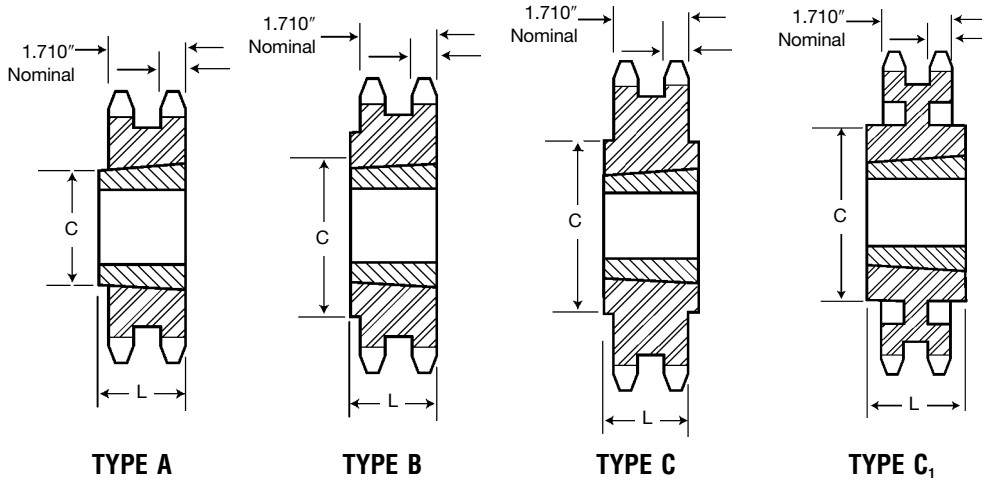

Double-Taper Bushed

No. Teeth	Catalog Number	Bushing	Diameter		Max. Bore	Dimensions			Weight (Approx.)	
			Outside Diameter	Pitch Diameter		L	C	Type	Rim Only	Bushing Only
13	D80ATB13H	1615	4.657	4.179	1½	1½		A	3.4	1.2
14	D80ATB14H	2012	4.982	4.494	2	1½		A	3.5	1.7
15	D80ATB15H	2012	5.305	4.810	2	1½		A	4.3	1.7
16	D80ATB16H	2517	5.627	5.126	2½	1¾	3¾	A	3.8	3.5
17	D80ATB17H	2517	5.950	5.442	2½	1¾	3¾	A	5.1	3.5
18	D80ATB18H	2517	6.271	5.759	2½	1¾	3¾	A	6.4	3.5
19	D80BTB19H	3020	6.593	6.076	3	2	5	B	5.6	6.5
20	D80BTB20H	3020	6.914	6.392	3	2	5½	B	7.1	6.5
21	D80BTB21H	3020	7.235	6.710	3	2	5¾	B	8.9	6.5
25	D80BTB25H	3020	8.516	7.979	3	2	6¾	B	16.5	6.5
30	D80CTB30	3020	10.114	9.567	3	2	5¾	C	25.1	6.5
36	D80CTB36	3020	12.030	11.474	3	2	5¾	C	39.4	6.5
42	D80CTB42	3020	13.944	13.392	3	2	5¾	C	36.4	6.5
45	D80CTB45	3020	14.901	14.336	3	2	5¾	C1	41.4	6.5
52	D80CTB52	3020	17.132	16.562	3	2	5¾	C1	56.2	6.5
60	D80CTB60	3020	19.681	19.107	3	2	5¾	C1	66.3	6.5
68	D80CTB68	3020	22.230	21.653	3	2	5¾	C1	72.0	6.5
76	D80CTB76	3020	24.778	24.198	3	2	5¾	C1	89.1	6.5
95	D80CTB95	3020	30.828	30.245	3	2	5¾	C1	112	6.5

NOTE: Double 80 stock sprockets with 25 teeth or less have hardened teeth. As indicated by H suffix.

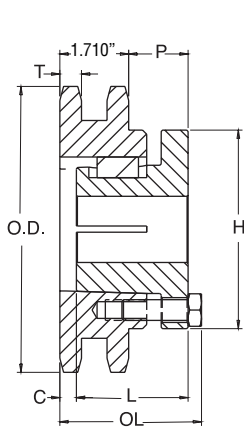

TYPE 12

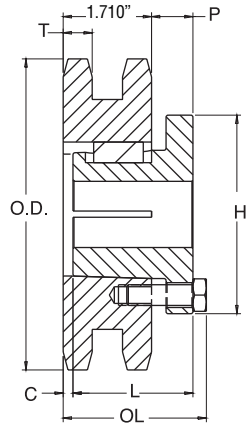

TYPE 13

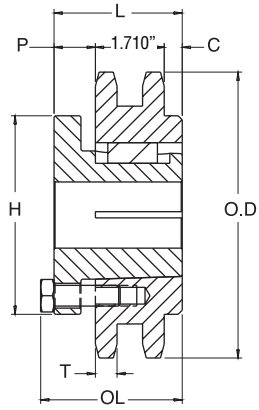

TYPE 15

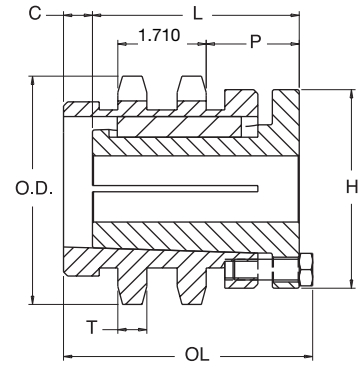

TYPE 16

Double-MST[®] Sprockets

No. Teeth	Catalog Number	Bush-ing	Diameters		Type	Max. Bore	Dimensions						Weight (Approx.)	
			Outside Dia.	Pitch Dia.			OL	L	C	H	P	T(nom)	With Hub	Rim Only
13	D80P13H	P1	4.660	4.179	13	1-3/4	2-19/32	1-15/16	13/32	3	5/8	.557	4.9	3.6
14	D80Q14H	Q2	4.980	4.494	16	2-5/8	4 5/8	3-1/2	27/32	4-1/8	1-3/4	.557	9.9	5.4
15	D80Q15H	Q2	5.300	4.810	12	2-5/8	3-25/32	3-1/2	0	4-1/8	13/4	.557	9.9	5.4
16	D80Q16H	Q1	5.630	5.126	13	2-11/16	2-25/32	2-1/2	0	4-1/8	3/4	.557	8.3	4.8
17	D80Q17H	Q1	5.950	5.442	13	2-11/16	2-25/32	2-1/2	0	4-1/8	3/4	.557	9.5	6.0
18	D80Q18H	Q1	6.270	5.759	13	2-11/16	2-25/32	2-1/2	0	4-1/8	3/4	.557	10.8	7.3
19	D80Q19H	Q1	6.590	6.076	13	2-11/16	2-25/32	2-1/2	0	4-1/8	3/4	.557	12.0	8.5
20	D80R20H	R1	6.910	6.392	12	3-3/4	3-5/32	2-7/8	0	5-3/8	1-5/32	.557	15.3	7.8
21	D80R21H	R1	7.240	6.710	12	3-3/4	3-5/32	2-7/8	0	5-3/8	1-5/32	.557	16.9	9.4
22	D80R22H	R1	7.560	7.027	12	3-3/4	3-5/32	2-7/8	0	5-3/8	1-5/32	.557	18.3	10.8
23	D80R23H	R1	7.880	7.344	12	3-3/4	3-5/32	2-7/8	0	5-3/8	1-5/32	.557	19.8	12.3
24	D80R24H	R1	8.200	7.661	12	3-3/4	3-5/32	2-7/8	0	5-3/8	1-5/32	.557	21.6	14.1
25	D80R25H	R1	8.520	7.979	12	3-3/4	3-5/32	2-7/8	0	5-3/8	1-5/32	.557	23.3	15.8
26	D80R26	R1	8.840	8.296	12	3-3/4	3-5/32	2-7/8	0	5-3/8	1-5/32	.557	25.6	18.1
27	D80R27	R1	9.160	8.614	12	3-3/4	3-5/32	2-7/8	0	5-3/8	1-5/32	.557	27.9	20.4
28	D80R28	R1	9.480	8.931	12	3-3/4	3-5/32	2-7/8	0	5-3/8	1-5/32	.557	30.2	22.7
30	D80R30	R1	10.110	9.567	12	3-3/4	3-5/32	2-7/8	0	5-3/8	1-5/32	.557	34.3	26.8
36	D80R36	R1	12.030	11.474	12	3-3/4	3-5/32	2-7/8	0	5-3/8	1-5/32	.557	49.1	41.6
42	D80R42	R1	13.940	13.382	12	3-3/4	3-5/32	2-7/8	0	5-3/8	1-5/32	.557	65.5	58.0
45	D80R45	R1	14.900	14.336	12	3-3/4	3-5/32	2-7/8	0	5-3/8	1-5/32	.557	75.5	68.0
48	D80R48	R2	15.860	15.290	15	3-5/8	5-5/32	4-7/8	2-9/32	5-3/8	7/8	.557	97.0	86.0
52	D80R52	R2	17.130	16.562	15	3-5/8	5-5/32	4-7/8	2-9/32	5-3/8	7/8	.557	114.0	103.0
54	D80R54	R2	17.770	17.198	15	3-5/8	5-5/32	4-7/8	2-9/32	5-3/8	7/8	.557	122.0	111.0
60	D80R60	R2	19.680	19.107	15	3-5/8	5-5/32	4-7/8	2-9/32	5-3/8	7/8	.557	146.0	135.0
68	D80R68	R2	22.230	21.653	15	3-5/8	5-5/32	4-7/8	2-9/32	5-3/8	7/8	.557	187.0	176.0
72	D80R72	R2	23.500	22.926	15	3-5/8	5-5/32	4-7/8	2-9/32	5-3/8	7/8	.557	209.0	198.0
76	D80U76	U0	24.780	24.198	15	5-1/2	5-23/32	5-1/4	2-1/32	8-3/8	1-1/2	.557	249.0	219.0
95	D80U95	U0	30.830	30.245	15	5 1/2	5-23/32	5-1/4	2-1/32	8-3/8	1-1/2	.557	372.0	342.0

Sprockets with "H" suffix have hardened teeth.

No. 80-3 1" Pitch

All Steel Stock Sprockets

Martin

SPROCKETS

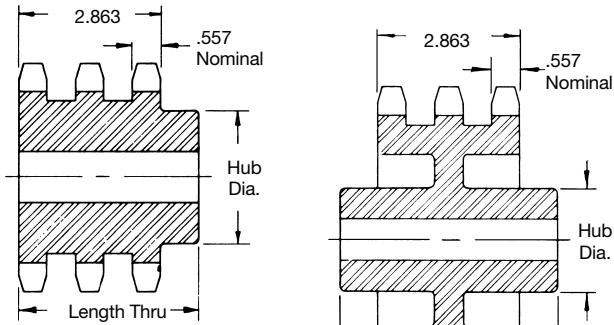

TYPE B

TYPE C

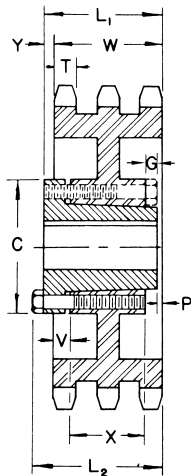

QD — TYPE B₁

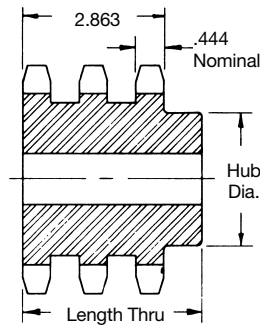

TYPE B

Triple-Type B & C

No. Teeth	Catalog Number	Outside Diameter	Type	Bore (inches)		Hub (inches)		Weight Lbs. (Approx.)
				Stock	Rec. Max.	Dia.	Length Thru	
11	E80B11H	4.010	B	1	1 1/4	2 1/2	3 3/8	5.9
12	E80B12H	4.330	B	1	1 1/4	2 7/16	3 3/8	7.5
13	E80B13H	4.660	B	1	2 1/4	3 3/16	3 3/8	9.2
14	E80B14H	4.980	B	1	2 3/4	3 1/2	3 3/8	11.0
15	E80B15H	5.300	B	1	2 1/2	3 3/4	3 3/8	13.1
16	E80B16H	5.630	B	1	2 3/4	4	3 3/8	15.8
17	E80B17H	5.950	B	1	3	4 1/4	3 3/8	18.6
18	E80B18H	6.270	B	1	3 1/4	4 3/4	3 3/8	21.2
19	E80B19H	6.590	B	1	3 5/8	5	3 3/8	23.7
20	E80B20H	6.910	B	1	3 5/8	5	3 3/8	26.0
21	E80B21H	7.240	B	1	3 5/8	5	3 3/8	28.4
22	E80B22H	7.560	B	1	3 5/8	5	3 3/8	31.0
23	E80B23H	7.880	B	1	3 5/8	5	3 3/8	33.6
24	E80B24H	8.200	B	1	3 5/8	5 1/4	3 3/8	37.1
25	E80B25H	8.520	B	1	3 5/8	5 1/4	3 3/8	40.1
26	E80B26	8.840	B	1	3 5/8	5 1/4	3 3/8	42.9
30	E80B30	10.110	B	1 1/4	3 3/4	5 3/4	4 1/2	54.5
35	E80B35	11.710	B	1 1/4	3 3/4	5 3/4	4 1/2	79.5
36	E80B36	12.030	B	1 1/4	3 3/4	5 3/4	4 1/2	83.9
42	E80C42	13.940	C	1 1/4	3 3/4	6	4 1/2	84.9
45	E80C45	14.900	C	1 1/4	3 3/4	6	4 1/2	92.4
52	E80C52	17.130	C	1 1/2	3 3/4	6	4 1/2	107
60	E80C60	19.680	C	1 1/2	4 1/4	6 1/4	4 1/2	128
68	E80C68	22.230	C	1 1/2	4 1/4	6 1/4	4 1/2	140
76	E80C76	24.780	C	1 1/2	4 1/4	6 1/4	4 1/2	165
95	E80C95	30.830	C	1 1/2	4 1/4	6 1/4	5	240

Maximum bores shown will accommodate standard keyseat and setscrew over keyseat. Slightly larger bores are possible with no keyseat, shallow keyseat, or setscrew at angle to keyseat. As indicated by H suffix.

TYPE QD



NOTE: Triple 80 stock sprockets with 25 teeth or less have hardened teeth.

Alteration Charges

See current discount sheet for alteration charges.

Triple-Type QD

No. Teeth	Catalog Number	Bush-ing	Diameters		Type	Max. Bore	Dimensions										Weight (Approx.)	
			Outside Diameter	Pitch Diameter			L ₁	L ₂	C	Y	P	G	V	X	T	W	With Hub	Rim Only
36	E80E36	E	12.030	11.474	B	3 1/2	3 3/4	3 7/16	6	1/4	3 1/16	1/8	5/8	1 1/8	.557	2.863	65.1	55.1
42	E80E42	E	13.940	13.382	B	3 1/2	3 3/4	3 3/4	6	1/4	3 1/16	1/8	5/8	1 1/8	.557	2.863	81.9	71.9
45	E80E45	E	14.900	14.336	B1	3 1/2	3 3/4	3 3/4	6	1/4	3 1/16	1/8	5/8	1 1/8	.557	2.863	75.3	65.3
52	E80E52	E	17.130	16.562	B1	3 1/2	3 3/4	3 3/4	6	1/4	3 1/16	1/8	5/8	1 1/8	.557	2.863	90.0	80.0
60	E80F60	F	19.680	19.107	B1	3 5/16	3 3/4	4 3/16	6 3/8	1 1/16	3/4	1/8	3/16	2 1/2	.557	2.863	112	100
68	E80F68	F	22.230	21.653	B1	3 5/16	3 3/4	4 3/16	6 3/8	1 1/16	3/4	1/8	3/16	2 1/2	.557	2.863	132	120
76	E80F76	F	24.780	24.198	B1	3 5/16	3 3/4	4 3/16	6 3/8	1 1/16	3/4	1/8	3/16	2 1/2	.557	2.863	150	138
95	E80F95	F	30.830	30.245	B1	3 5/16	3 3/4	4 3/16	6 3/8	1 1/16	3/4	1/8	3/16	2 1/2	.557	2.863	208	196

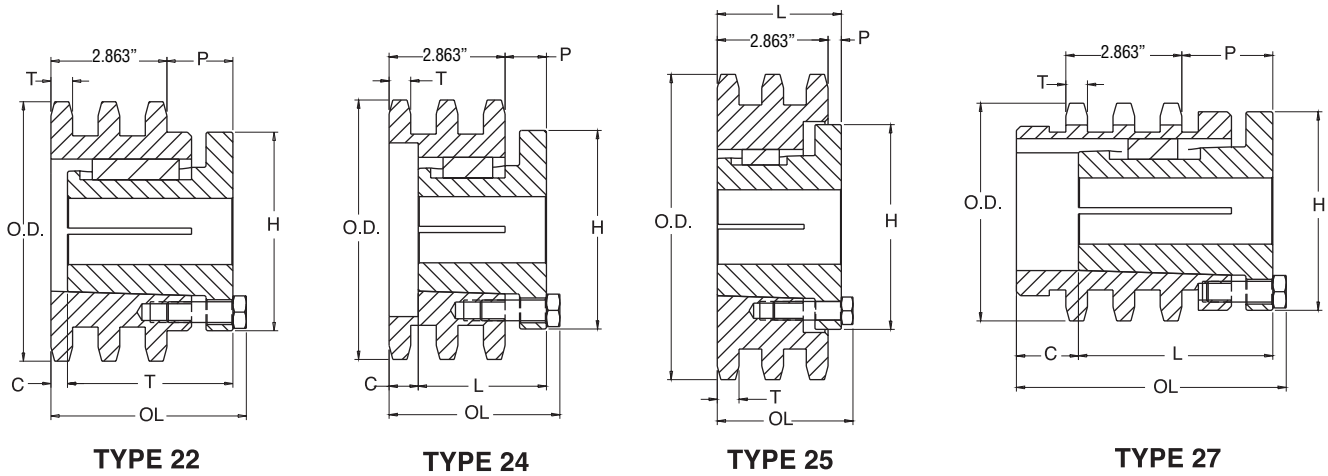

Triple - MST[®] Sprockets

No. Teeth	Catalog Number	Bushing	Diameters		Type	Max. Bore	Dimensions						Weight (Approx.)	
			Outside Dia.	Pitch Dia.			OL	L	C	H	P	T(nom)	With Hub	Rim Only
13	E80P13H	P2	4.660	4.179	24	1-3/4	3-3/4	2-15/16	9/16	3	5/8	.557	7.2	5.7
14	E80Q14H	Q2	4.980	4.494	27	2-5/8	5 25/32	3-1/2	2	4-1/8	1-3/4	.557	12.0	7.5
15	E80Q15H	Q2	5.300	4.810	22	2-5/8	4 29/32	3-1/2	1-1/8	4-1/8	1-3/4	.557	12.6	8.1
16	E80Q16H	Q2	5.630	5.126	25	2-5/8	3 7/8	3-1/2	3/32	4-1/8	3/4	.557	13.8	9.3
17	E80Q17H	Q2	5.950	5.442	24	2-5/8	3 29/32	3-1/2	1/8	4-1/8	3/4	.557	14.3	9.8
18	E80Q18H	Q2	6.270	5.759	24	2-5/8	3 29/32	3-1/2	1/8	4-1/8	3/4	.557	16.5	12.0
19	E80Q19H	Q2	6.590	6.076	24	2-5/8	3 29/32	3-1/2	1/8	4-1/8	3/4	.557	18.4	13.9
20	E80R20H	R1	6.910	6.392	24	3-3/4	4 1/32	2-7/8	7/8	5-3/8	7/8	.557	17.7	10.2
21	E80R21H	R1	7.240	6.710	24	3-3/4	4 1/32	2-7/8	7/8	5-3/8	7/8	.557	19.9	12.4
22	E80R22H	R1	7.560	7.027	24	3-3/4	4 1/32	2-7/8	7/8	5-3/8	7/8	.557	22.1	14.6
23	E80R23H	R1	7.880	7.344	25	3-3/4	3-5/32	2-7/8	0	5-3/8	0	.557	23.4	15.9
24	E80R24	R1	8.200	7.661	25	3-3/4	3-5/32	2-7/8	0	5-3/8	0	.557	7.2	18.5
25	E80R25	R1	8.520	7.979	25	3-3/4	3-5/32	2-7/8	0	5-3/8	0	.557	12.0	20.3
26	E80R26	R1	8.840	8.296	25	3-3/4	3-5/32	2-7/8	0	5-3/8	0	.557	12.6	23.4
27	E80R27	R1	9.160	8.614	25	3-3/4	3-5/32	2-7/8	0	5-3/8	0	.557	13.8	25.8
28	E80R28	R1	9.480	8.931	25	3-3/4	3-5/32	2-7/8	0	5-3/8	0	.557	14.3	28.1
30	E80R30	R1	10.110	9.567	25	3-3/4	3-5/32	2-7/8	0	5-3/8	0	.557	16.5	33.3
36	E80S36	S1	12.030	11.474	22	4-1/4	5-1/8	4-3/8	0	6-3/8	1-1/2	.557	18.4	67.0
42	E80S42	S1	13.940	13.382	22	4-1/4	5-1/8	4-3/8	0	6-3/8	1-1/2	.557	17.7	96.1
45	E80S45	S1	14.900	14.336	22	4-1/4	5-1/8	4-3/8	0	6-3/8	1-1/2	.557	19.9	112.0
52	E80U52	U0	17.130	16.562	22	5-1/2	5-23/32	5-1/4	0	8-3/8	1-25/32	.557	22.1	150.0
60	E80U60	U0	19.680	19.107	22	5-1/2	5-23/32	5-1/4	0	8-3/8	1-25/32	.557	23.4	207.0
68	E80U68	U0	22.230	21.653	22	5-1/2	5-23/32	5-1/4	0	8-3/8	1-25/32	.557	23.4	271.0
76	E80U76	U0	24.780	24.198	22	5-1/2	5-23/32	5-1/4	0	8-3/8	1-25/32	.557	23.4	344.0
95	E80U95	U0	30.830	30.245	25	5-1/2	5-55/64	5-1/4	1/32	8-3/8	1-13/32	.557	23.4	183.0

Sprockets with "H" suffix have hardened teeth.

No. 100
1¼" Pitch

All Steel
Stock Sprockets

Martin



BORED-TO-SIZE

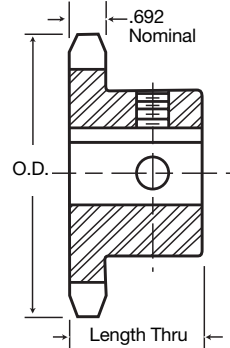

TYPE BS

SPROCKETS

Single Type "BS" — 2 Setscrews — Bored-To-Size

No. Teeth	Catalog Number	Outside Diameter	Length Thru Bore	Weight Lbs. (Approx.)	Stock Finished Bores Includes Keyway and Setscrews
8	100BS8	3.770	1½	2.8	1 - 1⅜ - 1¼
9	100BS9	4.180	1½	3.0	1 - 1⅜ - 1¼ - 1⅜
10	100BS10	4.600	1½	3.9	1 - 1⅜ - 1¼ - 1⅜
11	100BS11	5.010	1½	4.9	1 - 1⅜ - 1¼ - 1⅜ - 1⅜ - 2 - 2⅜
12	100BS12	5.420	1½	6.0	1 - 1⅜ - 1¼ - 1⅜ - 1⅜ - 2 - 2⅜
13	100BS13	5.820	1½	6.2	1 - 1⅜ - 1¼ - 1⅜ - 1⅜ - 2 - 2⅜
14	100BS14	6.230	1½	6.6	- 1¼ - 1⅜ - 1⅜ - 2 - 2⅜
15	100BS15	6.630	1¾	8.4	- 1¼ - 1⅜ - 1⅜ - 2 - 2⅜
16	100BS16	7.030	1¾	9.0	- 1⅜ - 1⅜ - 2 - 2⅜ - 2⅜ - 2⅜
17	100BS17	7.440	1¾	9.9	- 1⅜ - 1⅜ - 2 - 2⅜ - 2⅜ - 2⅜
18	100BS18	7.840	1¾	10.6	- 1⅜ - 1⅜ - 2 - 2⅜ - 2⅜ - 2⅜
19	100BS19	8.240	2	12.1	- 1⅜ - 1⅜ - 2 - 2⅜ - 2⅜ - 2⅜
20	100BS20	8.640	2	13.2	- 1⅜ - 1⅜ - 2 - 2⅜ - 2⅜ - 2⅜
21	100BS21	9.040	2	14.3	- 1⅜ - 1⅜ - 2 - 2⅜ - 2⅜ - 2⅜
22	100BS22	9.440	2	15.1	- 1⅜ - 1⅜ - 2 - 2⅜ - 2⅜ - 2⅜
23	100BS23	9.840	2	16.1	- 1⅜ - 1⅜ - 2 - 2⅜ - 2⅜ - 2⅜
24	100BS24	10.250	2	18.1	- 1⅜ - 1⅜ - 2 - 2⅜ - 2⅜ - 2⅜
25	100BS25	10.650	2	18.4	- 1⅜ - 1⅜ - 2 - 2⅜ - 2⅜ - 2⅜

Hub diameters vary to suit different bore sizes.

NOTE: KEYWAY IS ON CENTER LINE OF TOOTH.

Single-Type C — Steel

No. Teeth	Catalog Number	Outside Diameter	Bore (inches)		Hub (inches)		Weight Lbs. (Approx.)
			Stock	Rec. Max.	Diameter	Length	
10	100C10	4.600	1	1½	3½	2½	6.13
11	100C11	5.010	1	2¼	3⅝	2½	7.12
12	100C12	5.420	1	2⅝	4	2½	8.37
13	100C13	5.820	1	2¾	3¾	2½	10.00
14	100C14	6.230	1¼	2¾	4⅝	2½	12.19

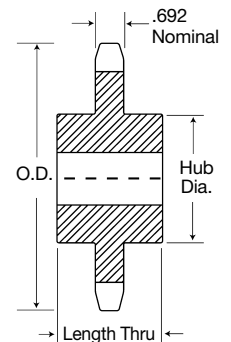

TYPE C

Martin

All Steel Stock Sprockets

No. 100 1¼" Pitch



Double Single-Type A — Steel

No. Teeth	Catalog Number	Diameters		Type	Min. Bore	Max. Bore	Dimensions				Wt. (Approx.)
		Outside Diameter	Pitch Diameter				L	C	E	w Nom.	
13	DS100A13	5.820	5.223	A	1	2½	2 ¹¹ / ₁₆	2	3 ³ / ₃₂	.692	11.2
14	DS100A14	6.230	5.617	A	1¼	2¾	2 ¹¹ / ₁₆	2	4 ¹ / ₁₆	.692	13.5
15	DS100A15	6.630	6.012	A	1¼	3 ¹ / ₁₆	2 ¹¹ / ₁₆	2	4 ¹⁹ / ₃₂	.692	16.8
16	DS100A16	7.030	6.407	A	1¼	3¼	2 ¹¹ / ₁₆	2	5	.692	19.3
17	DS100A17	7.440	6.803	A	1¼	3¾	2 ¹¹ / ₁₆	2	5 ¹³ / ₃₂	.692	21.5
18	DS100A18	7.840	7.198	A	1¼	3¾	2 ¹¹ / ₁₆	2	5 ⁵¹ / ₆₄	.692	23.0
19	DS100A19	8.240	7.595	A	1¼	4 ³ / ₁₆	2 ¹¹ / ₁₆	2	6 ¹³ / ₆₄	.692	25.0
20	DS100A20	8.640	7.991	A	1¼	4 ³ / ₁₆	2 ¹¹ / ₁₆	2	6 ³⁹ / ₆₄	.692	26.5
21	DS100A21	9.040	8.387	A	1¼	5¼	2 ¹¹ / ₁₆	2	7	.692	29.0

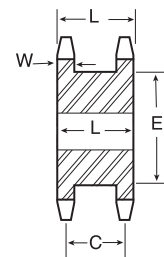

TYPE A

Double Single-Taper Bushed — Steel

No. Teeth	Catalog Number	Bushing Size	Diameters		Min. Bore	Max. Bore	Type	Dimensions				Wt. Rim Only	
			Outside Diameter	Pitch Diameter				L ₁	C	E	L ₂		w Nom.
15	DS100ATB15H	2517	6.630	6.012	¾	2½	A	2 ¹¹ / ₁₆	2	4 ¹⁹ / ₃₂	1¼	.692	12.5
16	DS100ATB16H	2517	7.030	6.407	¾	2½	A	2 ¹¹ / ₁₆	2	5	1¼	.692	13.0
17	DS100ATB17H	3020	7.440	6.803	¹⁵ / ₁₆	3	A	2 ¹¹ / ₁₆	2	5 ¹³ / ₃₂	2	.692	14.0
18	DS100ATB18H	3020	7.840	7.198	¹⁵ / ₁₆	3	A	2 ¹¹ / ₁₆	2	5 ⁵¹ / ₆₄	2	.692	16.0
19	DS100ATB19H	3020	8.240	7.595	¹⁵ / ₁₆	3	A	2 ¹¹ / ₁₆	2	6 ¹³ / ₆₄	2	.692	20.0
20	DS100ATB20H	3020	8.640	7.991	¹⁵ / ₁₆	3	A	2 ¹¹ / ₁₆	2	6 ³⁹ / ₆₄	1¼	.692	27.5
21	DS100ATB21H	3020	9.040	8.387	¹⁵ / ₁₆	3	A	2 ¹¹ / ₁₆	2	7	2	.692	27.5

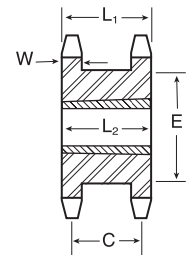

TAPER BUSH
TYPE A

Sprockets with "H" suffix have hardened teeth.

Double Single- MST® — Steel

No. Teeth	Catalog Number	Bushing Size	Diameters		Min. Bore	Max. Bore	Type	Dimensions				Wt. Rim Only	
			Outside Diameter	Pitch Diameter				L ₁	C	E	L ₂		w Nom.
17	DS100R17H	R1	7.440	6.803	1¼	3¾	B	2 ¹¹ / ₁₆	2	5 ¹³ / ₃₂	3 ²⁷ / ₃₂	.692	12.5
19	DS100R19H	R1	8.240	7.595	1¼	3¾	B	2 ¹¹ / ₁₆	2	6 ¹³ / ₆₄	3 ²⁷ / ₃₂	.692	18.8
21	DS100R21H	R1	9.040	8.387	1¼	3¾	B	2 ¹¹ / ₁₆	2	7	3 ²⁷ / ₃₂	.692	23.1

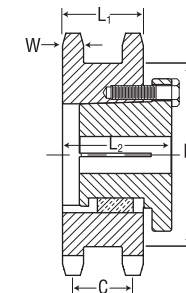

MST
TYPE B

Sprockets with "H" suffix have hardened teeth.

SPROCKETS

No. 100 1 1/4" Pitch

Stainless Steel Stock Sprockets

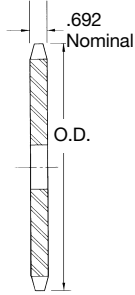

TYPE A

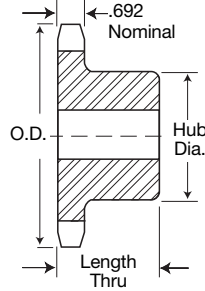

TYPE B

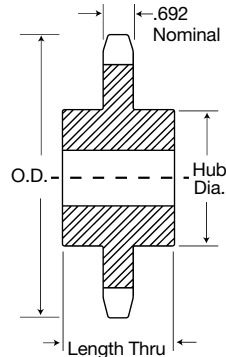

TYPE C

SPROCKETS

Single-Type B & C

Single-Type A

No. Teeth	Catalog Number	Outside Diameter	Type	Bore (inches)		Hub (inches)		Weight Lbs. (Approx.)	Type	Catalog Number	Stock Bore	Weight Lbs. (Approx.)
				Stock	Rec. Max.	Diameter	Length Thru					
11	100B11SS	5.010	B	1	2 1/4	3 5/8*	1 1/8	5.3				
12	100B12SS	5.420	B	1	2 1/4	4*	1 1/8	6.4				
13	100B13SS	5.820	B	1	2 1/2	3 3/8	1 1/8	6.6				
14	100B14SS	6.230	B	1 1/4	2 1/2	4 1/8	1 1/8	7.4				
15	100B15SS	6.630	B	1 1/4	3	4 1/2	1 1/8	9.2				
16	100B16SS	7.030	B	1 1/8	3	4 1/2	1 1/8	9.9	A	100A16SS	1 1/4	5.4
17	100B17SS	7.440	B	1 1/8	3	4 1/2	1 1/8	10.8	A	100A17SS	1 1/4	6.1
18	100B18SS	7.840	B	1 1/8	3	4 1/2	1 1/8	11.5	A	100A18SS	1 1/4	7.0
19	100B19SS	8.240	B	1 1/8	3	4 1/2	2	13.1	A	100A19SS	1 1/4	7.8
20	100B20SS	8.640	B	1 1/8	3	4 1/2	2	14.2	A	100A20SS	1 1/4	8.8
21	100B21SS	9.040	B	1 1/8	3	4 1/2	2	15.3	A	100A21SS	1 1/4	9.8

* Has recessed groove in hub for chain clearance.

Maximum bores shown will accommodate standard keyseat and setscrew over keyseat. Slightly larger bores are possible with no keyseat, shallow keyseat., or setscrew at angle to keyseat.

Alteration Charges

See current discount sheet for alteration charges.

Single-Type B & C

Single-Type A

No. Teeth	Catalog Number	Outside Diameter	Type	Bore (inches)		Hub (inches)		Weight Lbs. (Approx.)	Type	Catalog Number	Stock Bore	Weight Lbs. (Approx.)
				Stock	Rec. Max.	Diameter	Length Thru					
7		3.350							A	100A7	1	1.2
8	100B8	3.770	B	1	1¼	2½*	1¼	2.3	A	100A8	1	1.4
9	100B9	4.180	B	1	1½	2¾*	1¼	3.2	A	100A9	1	1.6
10	100B10	4.600	B	1	1¾	3¼*	1¼	4.1	A	100A10	1	2.0
11	100B11	5.010	B	1	2¼	3½*	1¼	5.3	A	100A11	1¼	2.5
12	100B12	5.420	B	1	2½	4*	1¼	6.4	A	100A12	1¼	3.0
13	100B13	5.820	B	1	2¾	3¾	1¼	6.6	A	100A13	1¼	3.5
14	100B14	6.230	B	1¼	2¾	4⅞	1¼	7.4	A	100A14	1¼	4.1
15	100B15	6.630	B	1⅞	3	4½	1¼	9.2	A	100A15	1¼	4.7
16	100B16	7.030	B	1⅞	3	4½	1¼	9.9	A	100A16	1¼	5.4
17	100B17	7.440	B	1⅞	3	4½	1¼	10.8	A	100A17	1¼	6.1
18	100B18	7.840	B	1⅞	3	4½	1¼	11.5	A	100A18	1¼	7.0
19	100B19	8.240	B	1⅞	3	4½	2	13.1	A	100A19	1¼	7.8
20	100B20	8.640	B	1⅞	3	4½	2	14.2	A	100A20	1¼	8.8
21	100B21	9.040	B	1⅞	3	4½	2	15.3	A	100A21	1¼	9.8
22	100B22	9.440	B	1⅞	3	4½	2	16.1	A	100A22	1¼	10.5
23	100B23	9.840	B	1¼	3	4½	2	17.2	A	100A23	1¼	11.8
24	100B24	10.250	B	1¼	3	4½	2	19.2	A	100A24	1¼	12.8
25	100B25	10.650	B	1¼	3	4½	2	19.5	A	100A25	1¼	13.9
26	100B26	11.050	B	1¼	3⅞	5	2	21.7	A	100A26	1¼	15.0
27	100B27	11.440	B	1¼	3⅞	5	2	23.0	A	100A27	1¼	16.0
28	100B28	11.840	B	1¼	3⅞	5	2	24.4	A	100A28	1¼	17.4
29	100B29	12.240	B	1¼	3⅞	5	2	25.0	A	100A29	1¼	19.6
30	100B30	12.640	B	1¼	3⅞	5	2	26.9	A	100A30	1¼	20.1
31		13.040							A	100A31	1¼	21.5
32	100B32	13.440	B	1¼	3⅞	5	2	29.8	A	100A32	1¼	22.6
33		13.840							A	100A33	1¼	24.1
34		14.240							A	100A34	1¼	26.0
35	100B35	14.640	B	1¼	3⅞	5	2½	36.9	A	100A35	1¼	27.2
36	100B36	15.040	B	1¼	3⅞	5	2½	38.6	A	100A36	1¼	30.0
37		15.440							A	100A37	1¼	31.0
38	100B38	15.840	B	1¼	3⅞	5	2½	41.5	A	100A38	1¼	33.0
39	100B39	16.230	B	1¼	3⅞	5	2½	43.6	A	100A39	1¼	35.0
40	100B40	16.630	B	1¼	3⅞	5	2½	46.9	A	100A40	1¼	36.0
41		17.030							A	100A41	1¼	39.0
42	100B42	17.430	B	1¼	3⅞	5	2½	50.4	A	100A42	1¼	40.0
43		17.830							A	100A43	1½	43.0
44		18.230							A	100A44	1½	45.0
45	100B45	18.630	B	1¼	3⅞	5	2½	54.0	A	100A45	1¼	47.0
46		19.020							A	100A46	1½	48.0
47		19.420							A	100A47	1½	52.0
48	100B48	19.820	B	1½	4	6	2½	66.0	A	100A48	1½	54.0
49		20.220							A	100A49	1½	56.0
50		20.620							A	100A50	1½	57.0
51		21.020							A	100A51	1½	63.0
52		21.420							A	100A52	1½	64.0
53		21.810							A	100A53	1½	64.2
54	100C54	22.210	C	1½	4	6	3¼	78.0	A	100A54	1½	68.0
55		22.610							A	100A55	1½	70.0
56		23.010							A	100A56	1½	72.0
57		23.410							A	100A57	1½	75.8
58		23.810							A	100A58	1½	76.0
59		24.200							A	100A59	1½	77.0
60	100C60	24.600	C	1½	4	6	3¼	89.0	A	100A60	1½	80.0
70	100C70	28.580	C	1½	5¼	7	3¾	125	A	100A70	1½	113
72	100C72	29.380	C	1½	5¼	7	3¾	134	A	100A72	1½	119
76	100C76	30.973	C	1½	5¼	7	3¾	143	A	100A76	1½	133
80	100C80	32.570	C	1½	5¼	7	3¾	151	A	100A80	1½	146
84	100C84	34.160	C	1½	5¼	7	3¾	170	A	100A84	1½	162
90	100C90	36.550	C	1½	5¼	7	3¾	184	A	100A90	1½	193
96	100C96	38.930	C	1½	5¼	7	4½	203	A	100A96	1½	215

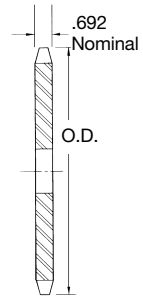

TYPE A

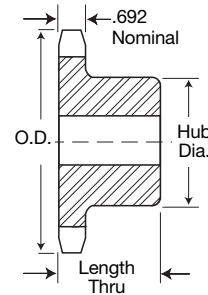

TYPE B

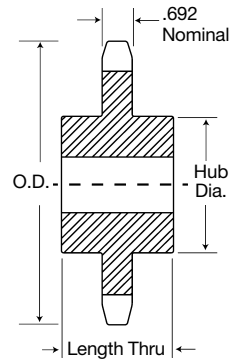

TYPE C

Alteration Charges

See current discount sheet for alteration charges.

* Has recessed groove in hub for chain clearance.

Maximum bores shown will accommodate standard keyseat and setscrew over keyseat. Slightly larger bores are possible with no keyseat, shallow keyseat, or setscrew at angle to keyseat.

No. 100 1 1/4" Pitch

All Steel Stock Sprockets

Martin

Single-Type QD With Hardened Teeth

No. Teeth	Catalog Number
11	100SDS11H
12	100SDS12H
13	100SK13H
14	100SK14H
15	100SF15H
16	100SF16H
17	100SF17H
18	100E18H
19	100E19H
20	100E20H
21	100E21H
22	100E22H
23	100E23H
24	100E24H
25	100E25H
26	100E26H
27	100E27H
28	100E28H
30	100E30H

**SABER
TOOTH®**

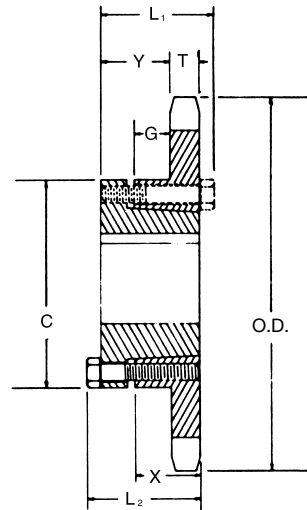

QD — TYPE B

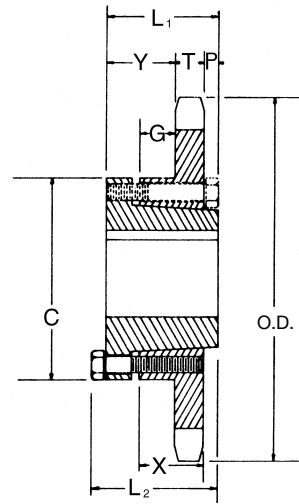

QD — TYPE B₁

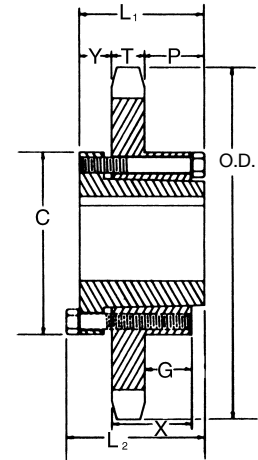

QD — TYPE C

Single-Type QD

No. Teeth	Catalog Number	Bush-ing	Diameters		Type	Max. Bore	Dimensions							Weight (Approx.)		
			Outside Diameter	Pitch Diameter			L ₁	L ₂	C	Y	P	G	X	T	With Hub	Rim Only
11	100SDS11	SDS	5.010	4.437	B	2	1 1/2	1 1/2	3 3/8	5/8		1/8	3/4	.692	3.0	2.0
12	100SDS12	SDS	5.420	4.830	B	2	1 1/2	1 1/2	3 3/8	5/8		1/8	3/4	.692	3.6	2.6
13	100SK13	SK	5.820	5.223	B	2 3/8	2 1/2	2 1/2	3 3/8	1 1/4		9/16	1 1/4	.692	5.3	3.3
14	100SK14	SK	6.230	5.617	B	2 3/8	2 1/2	2 1/2	3 3/8	1 1/4		9/16	1 1/4	.692	6.1	4.1
15	100SF15	SF	6.630	6.012	B	2 1/8	2 1/4	2 1/4	4 1/8	1 1/4		9/16	1 1/4	.692	7.8	4.8
16	100SF16	SF	7.030	6.407	B	2 1/8	2 1/4	2 1/4	4 1/8	1 1/4		9/16	1 1/4	.692	8.6	5.6
17	100SF17	SF	7.440	6.803	B	2 1/8	2 1/4	2 1/4	4 1/8	1 1/4		9/16	1 1/4	.692	9.5	6.5
18	100E18	E	7.840	7.198	B1	3 1/2	2 3/4	2 3/4	6	1 3/8	1/8	1 1/8	1 3/8	.692	19.0	9.0
19	100E19	E	8.240	7.595	B1										20.2	10.2
20	100E20	E	8.640	7.991	B1										21.6	11.6
21	100E21	E	9.040	8.387	B1										22.5	12.5
22	100E22	E	9.440	8.783	B1										23.5	13.5
23	100E23	E	9.840	9.180	B1										24.6	14.6
24	100E24	E	10.250	9.577	B1										25.7	15.7
25	100E25	E	10.650	9.973	B1										26.8	16.8
26	100E26	E	11.050	10.370	B1										28.1	18.1
27	100E27	E	11.440	10.767	B1										29.2	19.2
28	100E28	E	11.840	11.164	B1										30.7	20.7
30	100E30	E	12.640	11.958	B1										33.2	23.2
32	100E32	E	13.440	12.753	B1										35.4	25.4
35	100E35	E	14.640	13.945	B1										40.5	30.5
36	100E36	E	15.040	14.342	B1										42.5	32.3
40	100E40	E	16.630	15.932	B1										49.1	39.1
42	100E42	E	17.430	16.727	B1										53.4	43.4
45	100E45	E	18.630	17.920	B1										58.9	48.9
48	100E48	E	19.820	19.112	B1	3 1/2	2 3/4	2 3/4	6	1 1/8	1/8	1 1/8	1 3/8	.692	64.0	54.0
54	100E54	E	22.210	21.498	C	3 1/2	2 3/4	2 3/4	6	3/8	1 1/8	1 1/8	1 3/8	.692	72.0	62.0
60	100E60	E	24.600	23.884	C	3 1/2	2 3/4	2 3/4	6	3/8	1 1/8	1 1/8	1 3/8	.692	84.0	74.0
70	100F70	F	28.580	27.862	C	3 3/8	3 1/2	4	6 1/2	1	1 1/8	1 1/8	2 1/2	.692	110.5	99.0
72	100F72	F	29.380	28.657	C										117.5	106
80	100F80	F	32.570	31.839	C										134.5	123
84	100F84	F	34.160	33.430	C	3 3/8	3 1/2	4	6 1/2	1	1 1/8	1 1/8	2 1/2	.692	151.5	140

SPROCKETS

Single-Taper Bushed with Hardened Teeth

No. Teeth	Catalog Number
11	100BTB11H
12	100BTB12H
13	100BTB13H
14	100BTB14H
15	100BTB15H
16	100BTB16H
17	100BTB17H
18	100BTB18H
19	100BTB19H
20	100BTB20H
21	100BTB21H
22	100BTB22H
24	100BTB24H
26	100BTB26H
28	100BTB28H
30	100BTB30H

S
A
B
E
R

T
O
O
T
H[®]



Single-Taper Bushed

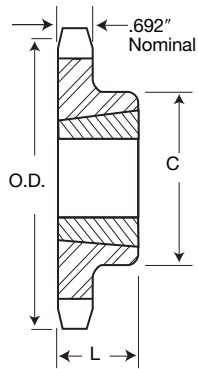

TYPE B

No. Teeth	Catalog Number	Bushing	Diameter		Max. Bore	Dimensions		Type	Weight (Approx.)	
			Outside Diameter	Pitch Diameter		L	C		Rim Only	Bushing Only
11	100BTB11	1615	5.007	4.437	1 1/2	1 1/2	3	B	2.7	1.2
12	100BTB12	1615	5.415	4.830	1 1/2	1 1/2	3 1/4	B	3.5	1.2
13	100BTB13	2012	5.821	5.223	2	1 1/4	3 3/8	B	3.6	1.7
14	100BTB14	2012	6.227	5.617	2	1 1/4	3 3/8	B	3.9	1.7
15	100BTB15	2517	6.631	6.012	2 1/2	1 1/4	4 1/4	B	5.0	3.5
16	100BTB16	2517	7.034	6.407	2 1/2	1 1/4	4 1/2	B	6.4	3.5
17	100BTB17	2517	7.437	6.803	2 1/2	1 1/4	4 1/2	B	7.1	3.5
18	100BTB18	2517	7.839	7.198	2 1/2	1 1/4	4 1/2	B	7.8	3.5
19	100BTB19	2517	8.241	7.594	2 1/2	1 1/4	4 1/2	B	8.7	3.5
20	100BTB20	2517	8.642	7.991	2 1/2	1 1/4	4 1/2	B	9.6	3.5
21	100BTB21	2517	9.043	8.387	2 1/2	1 1/4	4 1/2	B	10.6	3.5
22	100BTB22	2517	9.444	8.783	2 1/2	1 1/4	4 1/2	B	11.0	3.5
24	100BTB24	2517	10.245	9.577	2 1/2	1 1/4	4 1/2	B	13.0	3.5
26	100BTB26	2517	11.045	10.370	2 1/2	1 1/4	4 1/2	B	15.0	3.5
28	100BTB28	3020	11.844	11.164	3	2	5 1/4	B	16.5	6.5
30	100BTB30	3020	12.643	11.958	3	2	5 1/4	B	22.0	6.5
32	100BTB32	3020	13.442	12.753	3	2	5 1/4	B	23.0	6.5
35	100BTB35	3020	14.639	13.945	3	2	5 1/4	B	28.0	6.5
36	100BTB36	3020	15.038	14.342	3	2	5 1/4	B	31.0	6.5
40	100BTB40	3020	16.633	15.932	3	2	5 1/4	B	37.0	6.5
45	100BTB45	3020	18.626	17.919	3	2	5 1/4	B	46.0	6.5
48	100BTB48	3020	19.821	19.112	3	2	5 1/4	B	53.0	6.5
54	100BTB54	3020	22.212	21.498	3	2	5 1/4	B	62.0	6.5
60	100BTB60	3020	24.601	23.884	3	2	5 1/4	B	72.0	6.5

No. 100 1 1/4" Pitch

MST[®] Sprockets

Martin

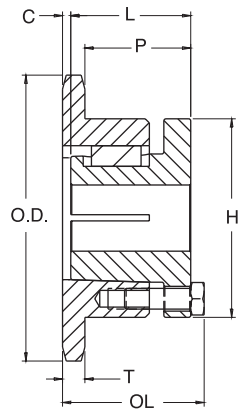

TYPE 4

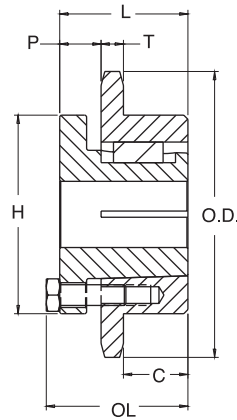

TYPE 5

Single - MST[®] Sprockets

No. Teeth	Catalog Number	Bushing	Diameters		Type	Max. Bore	Dimensions						Weight (Approx.)	
			Outside Dia.	Pitch Dia.			OL	L	C	H	P	T(nom)	With Hub	Rim Only
11	100P11H	P1	5.010	4.437	4	1-3/4	2-3/16	1-15/16	0	3	1-1/4	.692	4.1	2.8
12	100Q12H	Q1	5.420	4.830	4	2-11/16	2-27/32	2-1/2	1/16	4-1/8	1-7/8	.692	7.0	3.5
13	100Q13H	Q1	5.820	5.223	4	2-11/16	2-27/32	2-1/2	1/16	4-1/8	1-7/8	.692	7.8	4.3
14	100Q14H	Q1	6.230	5.617	4	2-11/16	2-25/32	2-1/2	0	4-1/8	1-13/16	.692	9.1	5.6
15	100Q15H	Q1	6.630	6.012	4	2-11/16	2-25/32	2-1/2	0	4-1/8	1-13/16	.692	10.1	6.6
16	100Q16H	Q1	7.030	6.407	4	2-11/16	2-25/32	2-1/2	0	4-1/8	1-13/16	.692	10.9	7.4
17	100Q17H	Q1	7.440	6.803	4	2-11/16	2-25/32	2-1/2	0	4-1/8	1-13/16	.692	11.7	8.2
18	100Q18H	Q1	7.840	7.198	4	2-11/16	2-25/32	2-1/2	0	4-1/8	1-13/16	.692	12.5	9.0
19	100Q19H	Q1	8.240	7.595	4	2-11/16	2-25/32	2-1/2	0	4-1/8	1-13/16	.692	13.3	9.8
20	100Q20H	Q1	8.640	7.991	4	2-11/16	2-25/32	2-1/2	0	4-1/8	1-13/16	.692	14.4	10.9
21	100Q21H	Q1	9.040	8.387	4	2-11/16	2-25/32	2-1/2	0	4-1/8	1-13/16	.692	15.3	11.8
21	100R21H	R1	9.040	8.387	4	3-3/4	3-5/32	2-7/8	0	5-3/8	2-3/16	.692	20.8	13.3
22	100Q22H	Q1	9.440	8.783	4	2-11/16	2-25/32	2-1/2	0	4-1/8	1-13/16	.692	16.1	12.6
23	100Q23H	Q1	9.840	9.180	4	2-11/16	2-25/32	2-1/2	0	4-1/8	1-13/16	.692	17.3	13.8
24	100Q24H	Q1	10.250	9.577	4	2-11/16	2-25/32	2-1/2	0	4-1/8	1-13/16	.692	18.9	15.4
24	100R24H	R1	10.250	9.577	4	3-3/4	3-5/32	2-7/8	0	5-3/8	2-3/16	.692	23.1	15.6
25	100Q25H	Q1	10.650	9.973	4	2-11/16	2-25/32	2-1/2	0	4-1/8	1-13/16	.692	19.5	16.0
25	100R25H	R1	10.650	9.973	4	3-3/4	3-5/32	2-7/8	0	5-3/8	2-3/16	.692	24.5	17.0
26	100Q26H	Q1	11.050	10.370	4	2-11/16	2-25/32	2-1/2	0	4-1/8	1-13/16	.692	20.8	17.3
26	100R26H	R1	11.050	10.370	4	3-3/4	3-5/32	2-7/8	0	5-3/8	2-3/16	.692	25.4	17.9
27	100Q27H	Q1	11.440	10.767	4	2-11/16	2-25/32	2-1/2	0	4-1/8	1-13/16	.692	21.7	18.2
27	100R27H	R1	11.440	10.767	4	3-3/4	3-5/32	2-7/8	0	5-3/8	2-3/16	.692	27.1	19.6
28	100Q28H	Q1	11.840	11.164	4	2-11/16	2-25/32	2-1/2	0	4-1/8	1-13/16	.692	23.1	19.6
28	100R28H	R1	11.840	11.164	4	3-3/4	3-5/32	2-7/8	0	5-3/8	2-3/16	.692	28.5	21.0
30	100Q30H	Q1	12.640	11.958	4	2-11/16	2-25/32	2-1/2	0	4-1/8	1-13/16	.692	25.9	22.4
30	100R30H	R1	12.640	11.958	4	3-3/4	3-5/32	2-7/8	0	5-3/8	2-3/16	.692	32.0	24.5
32	100Q32	Q1	13.440	12.753	4	2-11/16	2-25/32	2-1/2	0	4-1/8	1-13/16	.692	28.8	25.3
32	100R32	R1	13.440	12.753	4	3-3/4	3-5/32	2-7/8	0	5-3/8	2-3/16	.692	34.0	26.5
35	100Q35	Q1	14.640	13.945	4	2-11/16	2-25/32	2-1/2	0	4-1/8	1-13/16	.692	33.7	30.2
35	100R35	R1	14.640	13.945	4	3-3/4	3-5/32	2-7/8	0	5-3/8	2-3/16	.692	37.3	29.8
36	100R36	R1	15.040	14.342	4	3-3/4	3-5/32	2-7/8	0	5-3/8	2-3/16	.692	40.5	33.0
40	100R40	R1	16.630	15.932	4	3-3/4	3-5/32	2-7/8	0	5-3/8	2-3/16	.692	48.4	40.9
42	100R42	R1	17.430	16.727	4	3-3/4	3-5/32	2-7/8	0	5-3/8	2-3/16	.692	51.8	44.3
45	100R45	R1	18.630	17.920	4	3-3/4	3-5/32	2-7/8	0	5-3/8	2-3/16	.692	58.0	50.5
48	100R48	R1	19.820	19.112	4	3-3/4	3-5/32	2-7/8	0	5-3/8	2-3/16	.692	65.0	57.5
54	100R54	R1	22.210	21.498	5	3-3/4	3-5/32	2-7/8	1-5/16	5-3/8	7/8	.692	76.5	69.0
60	100R60	R1	24.600	23.884	5	3-3/4	3-5/32	2-7/8	1-5/16	5-3/8	7/8	.692	91.5	84.0
70	100R70	R1	28.580	27.862	5	3-3/4	3-5/32	2-7/8	1-5/16	5-3/8	7/8	.692	111.5	104.0
72	100R72	R1	29.380	28.657	5	3-3/4	3-5/32	2-7/8	1-5/16	5-3/8	7/8	.692	113.5	106.0
80	100R80	R1	32.570	31.839	5	3-3/4	3-5/32	2-7/8	1-5/16	5-3/8	7/8	.692	142.5	135.0
84	100R84	R1	34.160	33.430	5	3-3/4	3-5/32	2-7/8	1-5/16	5-3/8	7/8	.692	145.5	138.0

Sprockets with "H" suffix have hardened teeth.

Double-Type B & C

No. Teeth	Catalog Number	Outside Diameter	Type	Bore (inches)		Hub (inches)		Weight Lbs. (Approx.)
				Stock	Rec. Max.	Dia.	Length Thru	
9	D100B9	4.180	B	1	1 1/8	2 3/8	2 1/2	4.6
10	D100B10	4.600	B	1	1 1/8	2 3/8	2 1/2	6.2
11	D100B11	5.010	B	1	2 1/8	3 1/8	2 1/2	7.9
12	D100B12	5.420	B	1 1/8	2 1/4	3 3/8	2 1/2	9.3
13	D100B13	5.820	B	1 1/8	2 1/2	3 3/8	2 1/2	11.4
14	D100B14	6.230	B	1 1/8	2 3/4	4 1/8	2 1/2	13.6
15	D100B15	6.630	B	1 1/4	3 1/8	4 3/8	3 1/2	17.1
16	D100B16	7.030	B	1 1/4	3 1/4	5	3 1/2	20.1
17	D100B17	7.440	B	1 1/4	3 1/2	5 1/8	3 1/2	23.1
18	D100B18	7.840	B	1 1/4	3 3/4	5 3/8	3 1/2	25.4
19	D100B19	8.240	B	1 1/4	3 3/4	5 1/2	3 1/2	29.6
20	D100B20	8.640	B	1 1/4	3 3/4	5 1/2	3 1/2	32.4
21	D100B21	9.040	B	1 1/4	3 3/4	5 1/2	3 1/2	35.3
22	D100B22	9.440	B	1 1/4	3 3/4	5 1/2	3 1/2	38.4
23	D100B23	9.840	B	1 1/4	3 3/4	5 1/2	3 1/2	41.3
24	D100B24	10.250	B	1 1/4	3 3/4	5 1/2	3 1/2	45.1
25	D100B25	10.650	B	1 1/4	3 3/4	5 1/2	3 1/2	48.5
26	D100B26	11.050	B	1 1/2	3 3/4	5 3/4	3 1/2	51.5
30	D100B30	12.640	B	1 1/2	3 3/4	5 3/4	3 1/2	65.0
35	D100C35	14.640	C	1 1/2	3 3/4	6	4 1/4	75.0
45	D100C45	18.630	C	1 1/2	3 3/4	6	4 1/2	103
60	D100C60	24.600	C	1 1/2	5	7 1/2	5	175
70	D100C70	28.580	C	1 1/2	5	7 1/2	5	197
80	D100C80	32.570	C	1 1/2	5	7 1/2	5	231

Maximum bores shown will accommodate standard keyseat and setscrew over keyseat. Slightly larger bores are possible with no keyseat, shallow keyseat, or setscrew at angle to keyseat.

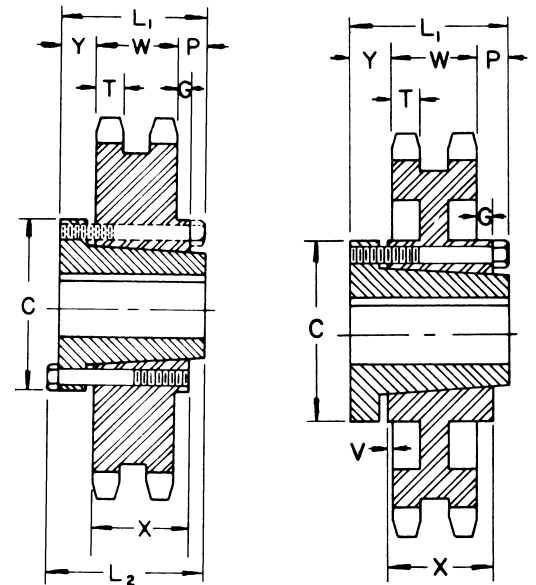
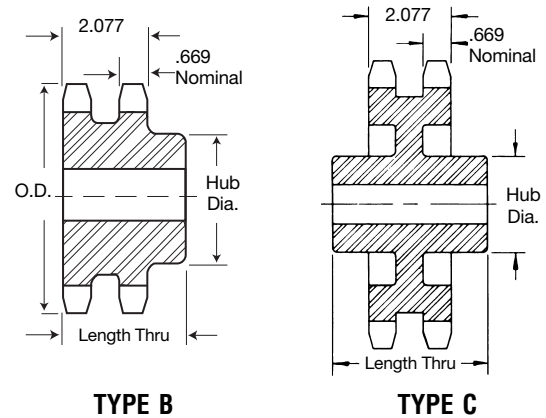

QD — TYPE C₂

QD — TYPE C₆

Alteration Charges

See current discount sheet for alteration charges.

Double-Type QD

No. Teeth	Catalog Number	Bushing	Diameters		Type	Max. Bore	Dimensions										Weight (Approx.)	
			Outside Diameter	Pitch Diameter			L ₁	L ₂	C	Y	P	G	V	X	T	W	With Hub	Rim Only
35	D100F35	F	14.640	13.945	C2	3 1/8	3 3/8	4	6 3/8	1	3/64	2/64		2 1/2	.669	2.077	84.5	73
45	D100F45	F	18.630	17.920	C2	3 3/8	3 3/8	4	6 3/8	1	3/64	2/64		2 1/2	.669	2.077	92.5	81
60	D100J60	J	24.600	23.884	C6	4 1/8	4 1/2	5	7 1/4	1 1/32	1 1/64	1 1/32	1/32	3 3/16	.669	2.077	152	133
70	D100J70	J	28.580	27.862	C6	4 1/8	4 1/2	5	7 1/4	1 1/32	1 1/64	1 1/32	1/32	3 3/16	.669	2.077	180	161
80	D100J80	J	32.570	31.839	C6	4 1/8	4 1/2	5	7 1/4	1 1/32	1 1/64	1 1/32	1/32	3 3/16	.669	2.077	215	196

No. 100-2 1-1/4" Pitch

MST[®] Sprockets

Martin

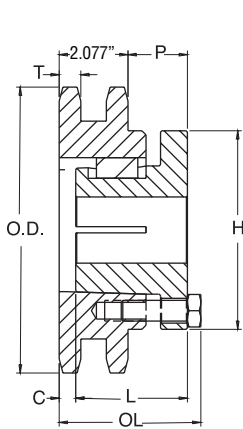

TYPE 12

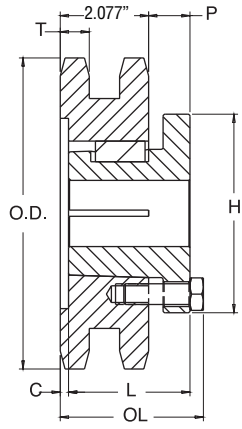

TYPE 14

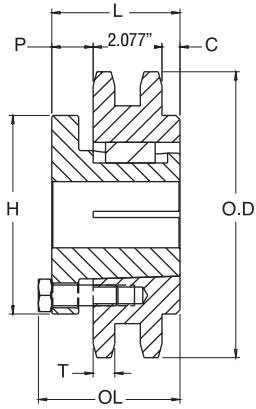

TYPE 15

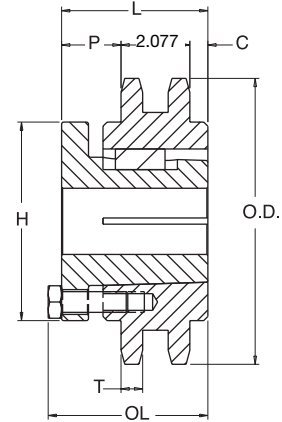

TYPE 18

SPROCKETS

Double - MST[®] Sprockets

No. Teeth	Catalog Number	Bush-ing	Diameters		Type	Max. Bore	Dimensions						Weight (Approx.)	
			Outside Dia.	Pitch Dia.			OL	L	C	H	P	T(nom)	With Hub	Rim Only
11	D100P11H	P1	5.010	4.437	14	1-3/4	2-15/16	1-15/16	3/4	3	5/8	.669	6.0	4.7
12	D100Q12H	Q2	5.420	4.830	12	2-5/8	4-7/32	3-1/2	7/16	4-1/8	1-55/64	.669	10.4	5.9
13	D100Q13H	Q2	5.820	5.223	12	2-5/8	4-7/32	3-1/2	7/16	4-1/8	1-55/64	.669	12.4	7.9
14	D100Q14H	Q1	6.230	5.617	14	2-11/16	3-3/32	2-1/2	5/16	4-1/8	3/4	.669	10.9	7.4
15	D100Q15H	Q1	6.630	6.012	14	2-11/16	3-3/32	2-1/2	5/16	4-1/8	3/4	.669	12.6	9.1
16	D100Q16H	Q1	7.030	6.407	14	2-11/16	3-3/32	2-1/2	5/16	4-1/8	3/4	.669	14.4	10.9
17	D100R17H	R1	7.440	6.803	14	3-3/4	3-7/32	2-7/8	1/16	5-3/8	7/8	.669	17.5	10.0
18	D100R18H	R1	7.840	7.198	14	3-3/4	3-7/32	2-7/8	1/16	5-3/8	7/8	.669	19.8	12.3
19	D100R19	R1	8.240	7.595	14	3-3/4	3-7/32	2-7/8	1/16	5-3/8	7/8	.669	22.4	14.9
20	D100R20	R1	8.640	7.991	14	3-3/4	3-7/32	2-7/8	1/16	5-3/8	7/8	.669	24.9	17.4
21	D100R21	R1	9.040	8.387	14	3-3/4	3-7/32	2-7/8	1/16	5-3/8	7/8	.669	27.8	20.3
22	D100R22	R1	9.440	8.783	14	3-3/4	3-7/32	2-7/8	1/16	5-3/8	7/8	.669	30.3	22.8
24	D100R24	R1	10.250	9.577	14	3-3/4	3-7/32	2-7/8	1/16	5-3/8	7/8	.669	37.0	29.5
35	D100R35	R1	14.640	13.945	14	3-3/4	3-7/32	2-7/8	1/16	5-3/8	7/8	.669	84.3	76.8
45	D100S45	S1	18.630	17.920	15	4-1/4	4-3/4	4-3/8	1-15/64	6-3/8	1-1/16	.669	151.5	138.0
60	D100S60	S1	24.600	23.884	15	4-1/4	4-3/4	4-3/8	1-15/64	6-3/8	1-1/16	.669	264.5	251.0
70	D100S70	S1	28.580	27.862	18	4-1/4	7-1/8	6-3/4	2 1/4	6-3/8	2-7/16	.669	371.5	358.0
80	D100S80	S1	32.570	31.839	18	4-1/4	7-1/8	6-3/4	2 1/4	6-3/8	2-7/16	.669	444.5	431.0

Sprockets with "H" suffix have hardened teeth.

Triple-Type B & C

No. Teeth	Catalog Number	Outside Diameter	Type	Bore (inches)		Hub (inches)		Weight Lbs. (Approx.)
				Stock	Rec. Max.	Dia.	Length Thru	
11	E100B11	5.010	B	1	2 1/2	3 1/2	4 1/4	11.7
12	E100B12	5.420	B	1 1/2	2 1/2	3	4 1/4	13.7
13	E100B13	5.820	B	1 1/2	2 1/2	3 3/8	4 1/4	16.9
14	E100B14	6.230	B	1 1/2	2 1/2	4 1/8	4 1/4	20.2
15	E100B15	6.630	B	1 1/4	3 3/8	4 1/2	4 1/2	25.0
16	E100B16	7.030	B	1 1/4	3 3/8	5	4 1/2	29.3
17	E100B17	7.440	B	1 1/4	3 3/8	5 1/2	4 1/2	33.8
18	E100B18	7.840	B	1 1/4	3 1/2	5 1/4	4 1/2	38.6
19	E100B19	8.240	B	1 1/4	3 3/4	5 1/2	4 1/2	43.3
20	E100B20	8.640	B	1 1/4	3 3/4	5 1/2	4 1/2	47.9
21	E100B21	9.040	B	1 1/4	3 3/4	5 1/2	4 1/2	52.3
22	E100B22	9.440	B	1 1/4	3 3/4	5 1/2	4 1/2	57.5
23	E100B23	9.840	B	1 1/4	3 3/4	5 1/2	4 1/2	62.5
24	E100B24	10.250	B	1 1/4	3 3/4	5 1/2	4 1/2	69
25	E100B25	10.650	B	1 1/4	3 3/4	5 1/2	4 1/2	73
26	E100B26	11.050	B	1 1/2	3 3/8	5 1/2	4 1/2	79
30	E100B30	12.640	B	1 1/2	3 13/16	5 1/2	4 1/2	103
35	E100C35	14.640	C	1 1/2	4	6	5	108
45	E100C45	18.630	C	1 1/2	4	6	5	143
60	E100C60	24.600	C	1 1/2	5 1/2	7 1/2	5	217
70	E100C70	28.580	C	1 1/2	5 1/2	7 1/2	5	262
80	E100C80	32.570	C	1 1/2	5 1/2	7 1/2	5	313

Maximum bores shown will accommodate standard keyseat and setscrew over keyseat. Slightly larger bores are possible with no keyseat, shallow keyseat, or setscrew at angle to keyseat.

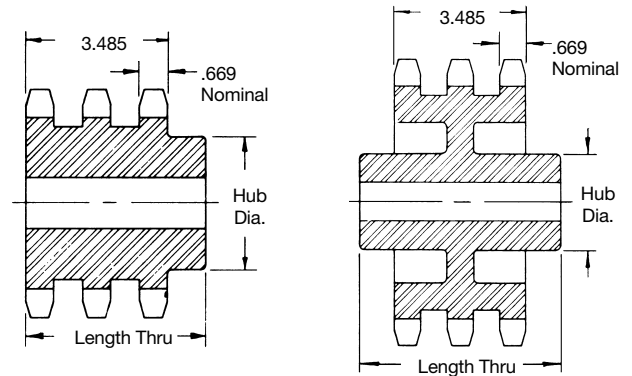

TYPE B

TYPE C

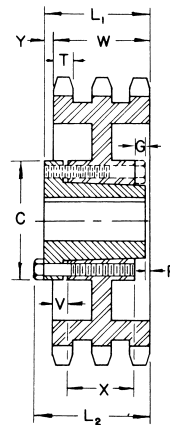

QD — TYPE B₁

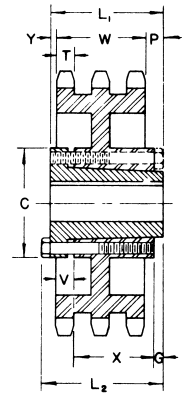

QD — TYPE C₃

Alteration Charges

See current discount sheet for alteration charges.

Triple-Type QD

No. Teeth	Catalog Number	Bush-ing	Diameters		Type	Max. Bore	Dimensions										Weight (Approx.)	
			Outside Diameter	Pitch Diameter			L ₁	L ₂	C	Y	P	G	V	X	T	W	With Hub	Rim Only
35	E100F35	F	14.640	13.945	B1	3 5/16	3 5/8	4 3/8	6 1/2	1/2	23/64	1/8	1/2	2 1/2	.669	3.485	112	100
45	E100F45	F	18.630	17.820	B1	3 3/8	3 5/8	4 3/8	6 1/2	1/2	23/64	1/8	1/2	2 1/2	.669	3.485	139	120
60	E100J60	J	24.600	28.884	C3	4 1/8	4 1/2	5	7 1/4	1/2	33/64	3/8	1 1/16	3 3/8	.669	3.485	197	178
70	E100J70	J	28.580	27.862	C3	4 1/8	4 1/2	5	7 1/4	1/2	33/64	3/8	1 1/16	3 3/8	.669	3.485	247	228
80	E100J80	J	32.570	31.839	C3	4 1/8	4 1/2	5	7 1/4	1/2	33/64	3/8	1 1/16	3 3/8	.669	3.485	287	268

No. 120 1½" Pitch

All Steel Stock Sprockets

Martin

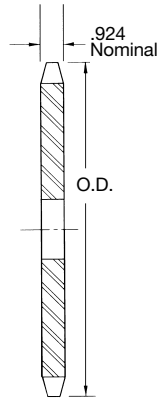

TYPE A

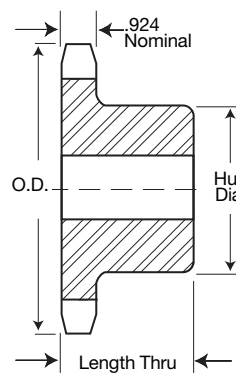

TYPE B

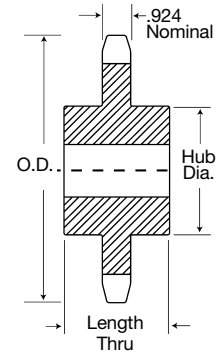

TYPE C

SPROCKETS

Single-Type B & C

Single-Type A

No. Teeth	Catalog Number	Outside Diameter	Type	Bore (inches)		Hub (inches)		Weight Lbs. (Approx.)	Type	Catalog Number	Stock Bore	Weight Lbs. (Approx.)
				Stock	Rec. Max.	Dia.	Length Thru					
8		4.520							A	120A8	1¼	2.4
9	120B9	5.020	B	1¾	1⅞	3¾*	2¼	5.3	A	120A9	1¼	3.0
10	120B10	5.520	B	1¾	2¼	3¾*	2¼	7.1	A	120A10	1¼	3.8
11	120B11	6.010	B	1¾	2¾	3¾	2¼	7.6	A	120A11	1¼	4.8
12	120B12	6.500	B	1¾	2¾	4¾	2¼	9.9	A	120A12	1¼	5.8
13	120B13	6.990	B	1¾	3	4¾	2¼	12.4	A	120A13	1¼	6.7
14	120B14	7.470	B	1¾	3¼	4¾	2¼	14.4	A	120A14	1¼	8.0
15	120B15	7.960	B	1¾	3¼	4¾	2¼	16.7	A	120A15	1¼	9.1
16	120B16	8.440	B	1¾	3½	5¼	2¼	19.9	A	120A16	1¼	10.6
17	120B17	8.920	B	1¾	3½	5¼	2¼	20.8	A	120A17	1¼	12.6
18	120B18	9.410	B	1¾	3½	5¼	2¼	22.2	A	120A18	1¼	13.6
19	120B19	9.890	B	1¾	3½	5¼	2¼	24.8	A	120A19	1¼	15.1
20	120B20	10.370	B	1¾	3½	5¼	2¼	25.8	A	120A20	1¼	16.9
21	120B21	10.850	B	1¾	3½	5¼	2¼	26.7	A	120A21	1¼	18.7
22	120B22	11.330	B	1¾	3½	5¼	2¼	28.2	A	120A22	1¼	20.0
23	120B23	11.810	B	1¾	3½	5¼	2¼	30.3	A	120A23	1¼	22.1
24	120B24	12.290	B	1¾	3½	5¼	2¼	32.1	A	120A24	1¼	24.8
25	120B25	12.770	B	1¾	3½	5¼	2¼	34.6	A	120A25	1¼	26.8
26	120B26	13.250	B	1¾	4	6	2¼	40.0	A	120A26	1½	28.3
27		13.730							A	120A27	1½	30.9
28	120B28	14.210	B	1½	4	6	2¼	44.9	A	120A28	1½	33.6
30	120B30	15.170	B	1½	4	6	2¼	50.2	A	120A30	1½	39.0
32	120B32	16.130	B	1½	4	6	2¼	56.0	A	120A32	1½	43.9
33		16.610							A	120A33	1½	48.2
34		17.090							A	120A34	1½	50
35	120B35	17.570	B	1½	4	6	2¼	62.4	A	120A35	1½	52
36	120B36	18.050	B	1½	4	6	2¼	66.4	A	120A36	1½	56
40	120C40	19.960	C	1½	4	6	3¾	92.0	A	120A40	1½	71
42	120C42	20.920	C	1½	4	6	3¾	98.0	A	120A42	1½	75
45	120C45	22.350	C	1½	4	6	3¾	99.2	A	120A45	1½	88
48	120C48	23.790	C	1½	4	6	4	113	A	120A48	1½	103
54	120C54	26.650	C	1½	4	6	4	133	A	120A54	1½	140
60	120C60	29.520	C	1½	5¼	7	4	160	A	120A60	1½	160
70	120C70	34.300	C	1½	5¼	7¼	4¼	206	A	120A70	1½	216
80	120C80	39.080	C	1½	5¼	7¼	4¼	254	A	120A80	1½	284
90		43.850							A	120A90	1½	358

* Has recessed groove in hub for chain clearance.

Maximum bores shown will accommodate standard keyseat and setscrew over keyseat. Slightly larger bores are possible with no keyseat, shallow keyseat, or setscrew at angle to keyseat.

Alteration Charges

See current discount sheet for alteration charges.

Martin

All Steel Stock Sprockets

No. 120

1½" Pitch

Single-Type QD With Hardened Teeth

No. Teeth	Catalog Number
12	120SF12H
13	120SF13H
14	120SF14H
15	120SF15H
16	120E16H
17	120E17H
18	120E18H
19	120E19H
20	120E20H
21	120E21H
22	120E22H
23	120E23H
24	120E24H
25	120E25H
26	120E26H
28	120E28H
30	120E30H

**SABER
TOOTH®**

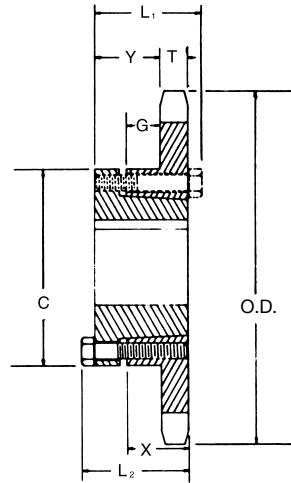
QD — TYPE B

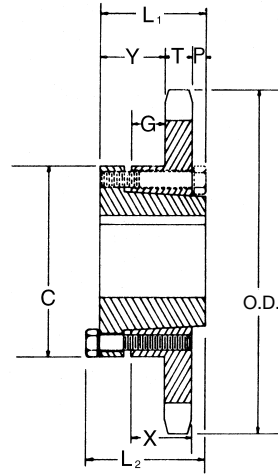

QD — TYPE B₁

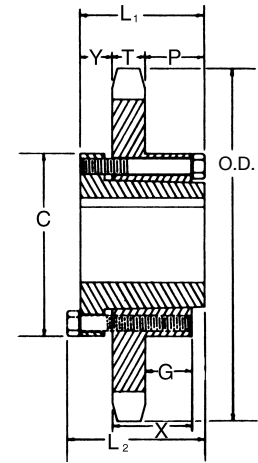

QD — TYPE C

Single-Type QD

No. Teeth	Catalog Number	Bushing	Diameters		Type	Max. Bore	Dimensions								Weight (Approx.)	
			Outside Diameter	Pitch Diameter			L ₁	L ₂	C	Y	P	G	X	T	With Hub	Rim Only
12	120SF12	SF	6.500	5.796	B	2 ¹⁵ / ₁₆	2 ¹ / ₄	2 ¹ / ₄	4 ⁵ / ₁₆	1 ¹ / ₄		2 ¹ / ₄	1 ¹ / ₄	.924	7.7	4.7
13	120SF13	SF	6.990	6.268	B										9.1	6.1
14	120SF14	SF	7.470	6.741	B										10.4	7.4
15	120SF15	SF	7.960	7.215	B	2 ¹⁵ / ₁₆	2 ¹ / ₄	2 ¹ / ₄	4 ⁵ / ₁₆	1 ¹ / ₄		2 ¹ / ₄	1 ¹ / ₄	.924	11.8	8.0
16	120E16	E	8.440	7.689	B1	3 ¹ / ₂	2 ⁵ / ₁₆	2 ⁵ / ₁₆	6	1 ¹ / ₁₆	1 ¹ / ₈	4 ⁵ / ₁₆	1 ¹ / ₁₆	.924	21.2	11.2
17	120E17	E	8.920	8.163	B1										23.4	13.4
18	120E18	E	9.410	8.638	B1										24.8	14.8
19	120E19	E	9.890	9.113	B1										26.5	16.5
20	120E20	E	10.370	9.589	B1										29.2	19.2
21	120E21	E	10.850	10.064	B1										29.9	19.9
22	120E22	E	11.330	10.540	B1										31.6	21.6
23	120E23	E	11.810	11.016	B1										33.8	23.8
24	120E24	E	12.290	11.492	B1										35.8	25.8
25	120E25	E	12.770	11.968	B1										38.1	28.1
26	120E26	E	13.250	12.444	B1										39.9	29.9
28	120E28	E	14.210	13.397	B1										49.7	34.7
30	120E30	E	15.170	14.350	B1	3 ¹ / ₂	2 ⁵ / ₁₆	2 ⁵ / ₁₆	6	1 ¹ / ₁₆	1 ¹ / ₈	4 ⁵ / ₁₆	1 ¹ / ₁₆	.924	49.4	39.4
32	120F32	F	16.130	15.303	C	3 ³ / ₁₆	3 ³ / ₁₆	4	6 ⁵ / ₁₆	1	1 ¹ / ₁₆	1 ³ / ₁₆	2 ¹ / ₂	.924	62.0	50.5
35	120F35	F	17.570	16.734	C										71.0	59.5
36	120F36	F	18.050	17.211	C										74.9	63.4
40	120F40	F	19.960	19.118	C										88.5	77.0
42	120F42	F	20.920	20.072	C										94.5	83.0
45	120F45	F	22.350	21.503	C										95.5	84.0
48	120F48	F	23.790	22.935	C										103.5	92.0
54	120F54	F	26.650	25.798	C	3 ⁷ / ₁₆	3 ⁷ / ₁₆	4	6 ⁵ / ₁₆	1	1 ¹ / ₁₆	1 ³ / ₁₆	2 ¹ / ₂	.924	125	114
60	120J60	J	29.520	28.661	C	4 ⁷ / ₁₆	4 ⁷ / ₁₆	5	7 ¹ / ₄	1 ¹ / ₁₆	2 ¹ / ₁₆	2 ¹ / ₁₆	3 ³ / ₁₆	.924	159	140
70	120J70	J	34.300	33.434	C	4 ⁷ / ₁₆	4 ⁷ / ₁₆	5	7 ¹ / ₄	1 ¹ / ₁₆	2 ¹ / ₁₆	2 ¹ / ₁₆	3 ³ / ₁₆	.924	196	177
80	120J80	J	39.080	38.207	C	4 ⁷ / ₁₆	4 ⁷ / ₁₆	5	7 ¹ / ₄	1 ¹ / ₁₆	2 ¹ / ₁₆	2 ¹ / ₁₆	3 ³ / ₁₆	.924	241	222

SPROCKETS

No. 120 1½" Pitch

All Steel Stock Sprockets

Martin

Single-Taper Bushed

No. Teeth	Catalog Number	Bushing	Diameter		Max. Bore	Dimensions		Type	Weight (Approx.)	
			Outside Diameter	Pitch Diameter		L	C		Rim Only	Bushing Only
12	120BTB12	2012	6.498	5.796	2	1¼	3⅞	B	5.5	1.7
13	120BTB13	2517	6.896	6.268	2½	1¼	4¼	B	6.0	3.5
14	120BTB14	2517	7.472	6.741	2½	1¼	4¼	B	7.0	3.5
15	120BTB15	2517	7.957	7.215	2½	1¼	4¼	B	8.0	3.5
16	120BTB16	3020	8.441	7.689	3	2	5¼	B	10.0	6.5
17	120BTB17	3020	8.924	8.163	3	2	5¼	B	11.0	6.5
18	120BTB18	3020	9.407	8.638	3	2	5¼	B	12.0	6.5
19	120BTB19	3020	9.889	9.113	3	2	5¼	B	14.0	6.5
20	120BTB20	3020	10.371	9.588	3	2	5¼	B	15.5	6.5
21	120BTB21	3020	10.851	10.064	3	2	5¼	B	17.5	6.5
24	120BTB24	3020	12.294	11.492	3	2	5¼	B	23.5	6.5
26	120BTB26	3020	13.254	12.444	3	2	5¼	B	28.5	6.5
30	120BTB30	3020	15.171	14.351	3	2	5¼	B	33.5	6.5
35	120CTB35	3020	17.566	16.734	3	2	5¼	C	52.0	6.5
45	120CTB45	3030	22.351	21.503	3	3	5¼	C	82.0	9.2
60	120CTB60	3535	29.522	28.661	3½	3½	6¼	C	140.0	14.0
70	120CTB70	3535	34.301	33.434	3½	3½	6¼	C	175.0	14.0
80	120CTB80	3535	39.078	38.207	3½	3½	6¼	C	220.0	14.0

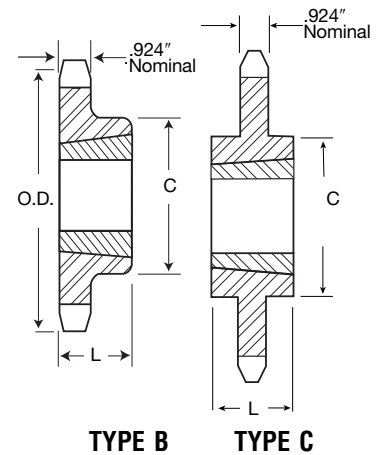

SPROCKETS

Single-Taper Bushed with Hardened Teeth

No. Teeth	Catalog Number
12	120BTB12 H
13	120BTB13 H
14	120BTB14 H
15	120BTB15 H
16	120BTB16 H
17	120BTB17 H
18	120BTB18 H
19	120BTB19 H
20	120BTB20 H
21	120BTB21 H
24	120BTB24 H
26	120BTB26 H
30	120BTB30 H

**SABER
TOOTH®**



Single-Type C — Steel 1½" Pitch

No. Teeth	Catalog Number	Outside Diameter	Bore (inches)		Hub (inches)		Weight Lbs. (Approx.)
			Stock	Rec. Max.	Diameter	Length	
11	120C11	6.010	1%	2%	3⅞	3%	12.45
12	120C12	6.500	1%	2%	4⅞	3%	14.80
13	120C13	6.990	1%	3	4%	3%	17.15
14	120C14	7.470	1%	3¼	4%	3%	19.50

Double Single-Type A — Steel

No. Teeth	Catalog Number	Diameters		Type	Min. Bore	Max. Bore	Dimensions			Wt. (Approx.)	
		Outside Diameter	Pitch Diameter				L	C	E		
15	DS120A15	7.960	7.215	A	1⅞	3¾	3⅞	2⅞	5⅜	.924	30.0
16	DS120A16	8.440	7.689	A	1⅞	4	3⅞	2⅞	6	.924	34.0
17	DS120A17	8.920	8.163	A	1⅞	4⅞	3⅞	2⅞	6⅜	.924	37.0
18	DS120A18	9.410	8.638	A	1⅞	5⅞	3⅞	2⅞	6⅜	.924	42.0
19	DS120A19	9.890	9.113	A	1⅞	5½	3⅞	2⅞	7⅞	.924	47.0
20	DS120A20	10.370	9.589	A	1⅞	5⅞	3⅞	2⅞	7⅞	.924	51.0

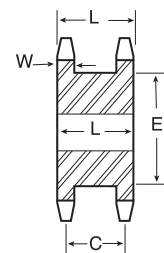

TYPE A

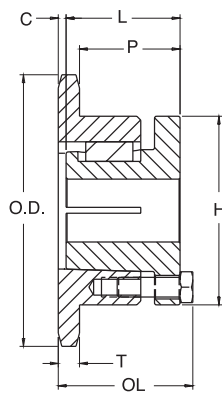

TYPE 4

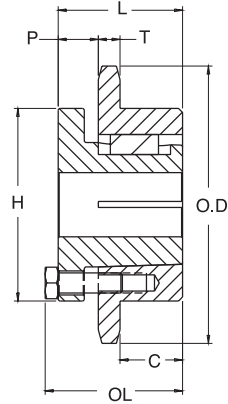

TYPE 5

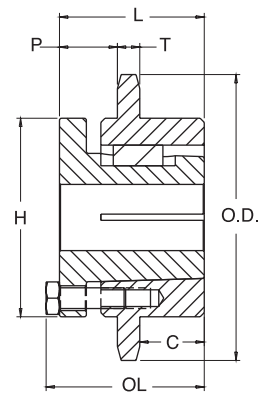

TYPE 6

Single - MST Sprockets

No. Teeth	Catalog Number	Bush- ing	Diameters		Type	Max. Bore	Dimensions						Weight (Approx.)	
			Outside Dia.	Pitch Dia.			OL	L	C	H	P	T(nom)	With Hub	Rim Only
11	120Q11H	Q1	6.010	5.324	4	2-11/16	2-25/32	2-1/2	0	4-1/8	1 9/16	.924	8.3	4.8
12	120Q12H	Q1	6.500	5.796	4	2-11/16	2-25/32	2-1/2	0	4-1/8	1 9/16	.924	9.8	6.3
13	120Q13H	Q1	6.990	6.268	4	2-11/16	2-25/32	2-1/2	0	4-1/8	1 9/16	.924	11.4	7.9
14	120Q14H	Q1	7.470	6.741	4	2-11/16	2-25/32	2-1/2	0	4-1/8	1 9/16	.924	12.7	9.2
15	120Q15H	Q1	7.960	7.215	4	2-11/16	2-25/32	2-1/2	0	4-1/8	1 9/16	.924	13.9	10.4
16	120Q16H	Q1	8.440	7.689	4	2-11/16	2-25/32	2-1/2	0	4-1/8	1-15/16	.924	15.3	11.8
16	120R16H	R1	8.440	7.689	4	3-3/4	3-5/32	2-7/8	0	5-3/8	1-15/16	.924	19.5	12.0
17	120Q17H	Q1	8.920	8.163	4	2-11/16	2-25/32	2-1/2	0	4-1/8	1-15/16	.924	16.9	13.4
17	120R17H	R1	8.920	8.163	4	3-3/4	3-5/32	2-7/8	0	5-3/8	1-15/16	.924	21.2	13.7
18	120Q18H	Q1	9.410	8.638	4	2-11/16	2-25/32	2-1/2	0	4-1/8	1-15/16	.924	19.1	15.6
18	120R18H	R1	9.410	8.638	4	3-3/4	3-5/32	2-7/8	0	5-3/8	1-15/16	.924	22.5	15.0
19	120R19H	R1	9.890	9.113	4	3-3/4	3-5/32	2-7/8	0	5-3/8	1-15/16	.924	24.4	16.9
20	120R20H	R1	10.370	9.589	4	3-3/4	3-5/32	2-7/8	0	5-3/8	1-15/16	.924	26.3	18.8
21	120R21H	R1	10.850	10.064	4	3-3/4	3-5/32	2-7/8	0	5-3/8	1-15/16	.924	28.2	20.7
22	120R22H	R1	11.330	10.540	4	3-3/4	3-5/32	2-7/8	0	5-3/8	1-15/16	.924	30.0	22.5
23	120R23H	R1	11.810	11.016	4	3-3/4	3-5/32	2-7/8	0	5-3/8	1-15/16	.924	31.8	24.3
24	120R24H	R1	12.290	11.492	4	3-3/4	3-5/32	2-7/8	0	5-3/8	1-15/16	.924	34.6	27.1
25	120R25H	R1	12.770	11.968	4	3-3/4	3-5/32	2-7/8	0	5-3/8	1-15/16	.924	36.6	29.1
26	120R26H	R1	13.250	12.444	5	3-3/4	3-5/32	2-7/8	1-1/16	5-3/8	7/8	.924	40.8	33.3
28	120R28H	R1	14.210	13.397	5	3-3/4	3-5/32	2-7/8	1-1/16	5-3/8	7/8	.924	45.5	38.0
30	120R30H	R1	15.170	14.350	5	3-3/4	3-5/32	2-7/8	1-1/16	5-3/8	7/8	.924	50.8	43.3
32	120R32	R1	16.130	15.303	5	3-3/4	3-5/32	2-7/8	1-1/16	5-3/8	7/8	.924	56.9	49.4
35	120R35	R2	17.570	16.734	6	3-5/8	5-5/32	4-7/8	2	5-3/8	1-15/16	.924	79.0	68.0
36	120R36	R2	18.050	17.211	6	3-5/8	5-5/32	4-7/8	2	5-3/8	1-15/16	.924	83.0	72.0
40	120R40	R2	19.960	19.118	6	3-5/8	5-5/32	4-7/8	2	5-3/8	1-15/16	.924	93.0	82.0
40	120S40	S1	19.960	19.118	5	4-1/4	4-3/4	4-3/8	2-3/8	6-3/8	1-1/16	.924	96.5	83.0
42	120S42	S1	20.920	20.072	5	4-1/4	4-3/4	4-3/8	2-3/8	6-3/8	1-1/16	.924	103.5	90.0
45	120R45	R2	22.350	21.503	6	3-5/8	5-5/32	4-7/8	2	5-3/8	1-15/16	.924	113.0	102.0
45	120S45	S1	22.350	21.503	5	4-1/4	4-3/4	4-3/8	2-3/8	6-3/8	1-1/16	.924	113.5	100.0
48	120S48	S1	23.790	22.935	5	4-1/4	4-3/4	4-3/8	2-3/8	6-3/8	1-1/16	.924	124.5	111.0
54	120S54	S1	26.650	25.798	5	4-1/4	4-3/4	4-3/8	2-3/8	6-3/8	1-1/16	.924	151.5	138.0
60	120R60	R2	29.520	28.661	6	3-5/8	5-5/32	4-7/8	2	5-3/8	1-15/16	.924	190.0	179.0
60	120S60	S1	29.520	28.661	5	4-1/4	4-3/4	4-3/8	2-3/8	6-3/8	1-1/16	.924	193.5	180.0
70	120R70	R2	34.300	33.434	6	3-5/8	5-5/32	4-7/8	2	5-3/8	1-15/16	.924	159.0	148.0
70	120S70	S2	34.300	33.434	5	4-3/16	7-1/8	6-3/4	2-7/8	6-3/8	2-15/16	.924	186.0	167.0
80	120R80	R2	39.080	38.207	6	3-5/8	5-5/32	4-7/8	2	5-3/8	1-15/16	.924	302.0	291.0
80	120S80	S2	39.080	38.207	6	4-3/16	7-1/8	6-3/4	2-7/8	6-3/8	2-15/16	.924	324.0	305.0

Sprockets with "H" suffix have hardened teeth.

No. 120-2

1½" Pitch

All Steel Stock Sprockets

Martin

Double-Type B & C

No. Teeth	Catalog Number	Outside Diameter	Type	Bore (inches)		Hub (inches)		Weight Lbs. (Approx.)
				Stock	Rec. Max.	Dia.	Length Thru	
11	D120B11	6.010	B	1½	2¾	3⅞	3¾	13.6
12	D120B12	6.500	B	1½	2¾	4⅞	3¾	17.3
13	D120B13	6.990	B	1½	3	4⅞	3¾	21.1
14	D120B14	7.470	B	1½	3⅞	5	3¾	25.6
15	D120B15	7.960	B	1½	3½	5¼	3¾	29.9
16	D120B16	8.440	B	1½	3½	5¼	3¾	33.8
17	D120B17	8.920	B	1½	3½	5¼	3¾	36.9
18	D120B18	9.410	B	1½	3½	5¼	3¾	41.9
19	D120B19	9.890	B	1½	3½	5¼	3¾	46.5
20	D120B20	10.370	B	1½	3½	5¼	3¾	50.2
21	D120B21	10.850	B	1½	3½	5¼	3¾	55.6
22	D120B22	11.330	B	1½	3⅞	5	4	64.0
23	D120B23	11.810	B	1½	4	6½	4	75.0
24	D120B24	12.290	B	1½	4	6½	4	79.0
25	D120B25	12.770	B	1½	4	6½	4	84.0
26	D120B26	13.250	B	1½	4	6½	4	90.0
30	D120B30	15.170	B	1½	4	6½	4	119
35	D120C35	17.570	C	1½	5	7½	6	148
45	D120C45	22.350	C	1½	5	7½	6	188
60	D120C60	29.520	C	1½	6	9½	6	307

Maximum bores shown will accommodate standard keyseat and setscrew over keyseat. Slightly larger bores are possible with no keyseat, shallow keyseat, or setscrew at angle to keyseat.

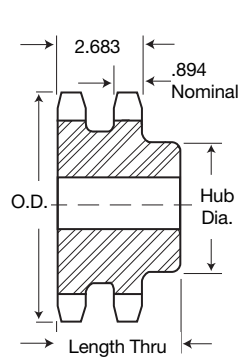

TYPE B

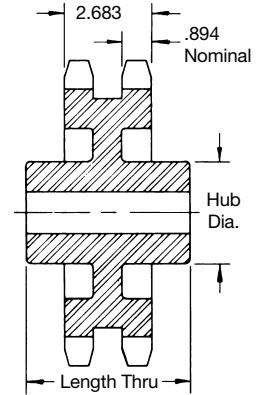

TYPE C

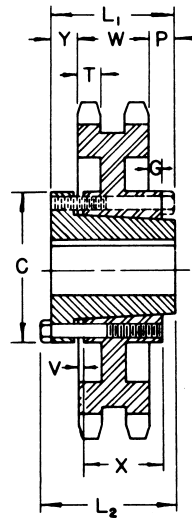

"QD" — TYPE C₅

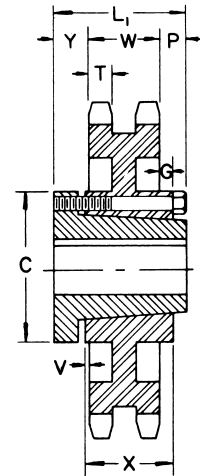

"QD" — TYPE C₆

Alteration Charges

See current discount sheet for alteration charges.

Double-Type "QD"

No. Teeth	Catalog Number	Bush-ing	Diameters		Type	Max. Bore	Dimensions									Weight (Approx.)		
			Outside Diameter	Pitch Diameter			L ₁	L ₂	C	Y	P	G	V	X	T	W	With Hub	Rim Only
30	D120J30	J	15.170	14.350	C5	4⅞	4½	5	7¼	1½	2⅝	2⅞	⅝	3⅞	.894	2.683	97.5	78.0
35	D120J35	J	17.570	16.734	C5	4⅞	4½	5	7¼	1½	2⅝	2⅞	⅝	3⅞	.894	2.683	112	93.0
45	D120J45	J	22.350	21.502	C5	4⅞	4½	5	7¼	1½	2⅝	2⅞	⅝	3⅞	.894	2.683	157	138
60	D120M60	M	29.520	28.661	C6	5	6	6	9	2⅝	1⅞	1⅞	2⅞	5⅞	.894	2.683	271	234

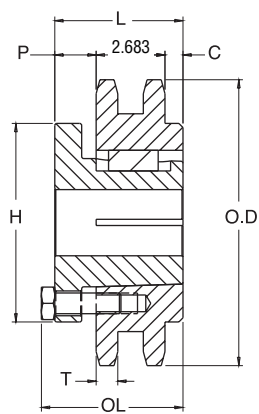

TYPE 15

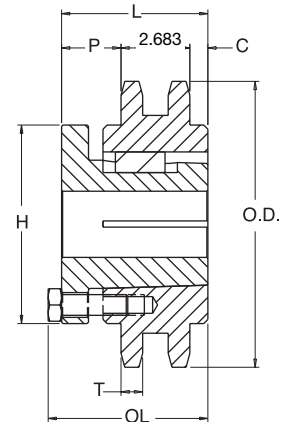

TYPE 18

Double - MST[®] Sprockets

No. Teeth		Bush- ing	Diameters		Type	Max. Bore	Dimensions						Weight (Approx.)	
			Outside Dia.	Pitch Dia.			OL	L	C	H	P	T(nom)	With Hub	Rim Only
30	D120S30	S1	15.170	14.350	15	4-1/4	4-3/4	4-3/8	5/8	6-3/8	1-1/16	.894	118.5	105.0
35	D120S35	S1	17.570	16.734	15	4-1/4	4-3/4	4-3/8	5/8	6-3/8	1-1/16	.894	161.5	148.0
45	D120S45	S2	22.350	21.503	18	4-3/16	7-1/8	6-3/4	1-27/32	6-3/8	2-7/32	.894	287.0	268.0
60	D120U60	U0	29.520	28.661	15	5-1/2	5-23/32	5-1/4	1-9/32	8-3/8	19/32	.894	213.0	183.0

Sprockets with "H" suffix have hardened teeth.

No. 140

1 3/4" Pitch

All Steel Stock Sprockets

Martin

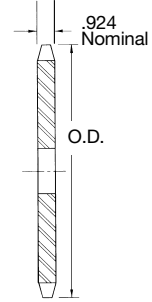

TYPE A

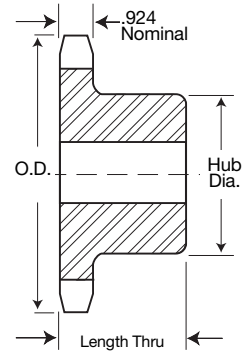

TYPE B

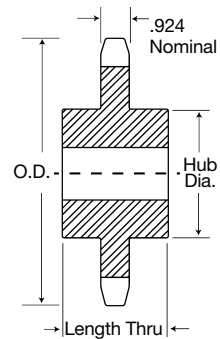

TYPE C

Single-Type B & C

Single-Type A

No. Teeth	Catalog Number	Outside Diameter	Type	Bore (inches)		Hub (inches)		Weight Lbs (Approx.)	Type	Catalog Number	Stock Bore	Weight Lbs. (Approx.)
				Stock	Rec. Max.	Dia.	Length Thru					
11	140B11	7.010	B	1 1/2	2 3/4	4 1/4	2 1/4	11.3	A	140A11	1 1/2	5.0
12	140B12	7.580	B	1 1/2	3	4 1/2	2 1/2	13.2	A	140A12	1 1/2	7.8
13	140B13	8.150	B	1 1/2	3 5/16	5 5/16	2 3/8	18.9	A	140A13	1 1/2	8.2
14	140B14	8.720	B	1 1/2	3 1/2	5 1/2	2 3/8	20.4	A	140A14	1 1/2	10.0
15	140B15	9.280	B	1 1/2	4 1/4	6 1/4	2 3/8	25.1	A	140A15	1 1/2	11.0
16	140B16	9.850	B	1 1/2	4 1/2	6 1/2	2 3/8	27.9	A	140A16	1 1/2	14.0
17	140B17	10.410	B	1 1/2	4 3/4	6 3/4	2 3/8	29.8	A	140A17	1 1/2	16.0
18	140B18	10.980	B	1 1/2	4 3/4	6 3/4	2 3/8	32.0	A	140A18	1 1/2	18.0
19	140B19	11.540	B	1 1/2	4 3/4	6 3/4	2 3/8	34.1	A	140A19	1 1/2	21.0
20	140B20	12.100	B	1 1/2	4 3/4	6 3/4	2 3/8	36.0	A	140A20	1 1/2	23.0
21	140B21	12.660	B	1 1/2	4 3/4	6 3/4	2 3/8	38.7	A	140A21	1 1/2	25.0
22	140B22	13.220	B	1 1/2	4 3/4	6 3/4	2 3/8	40.6	A	140A22	1 1/2	28.0
23	140B23	13.780	B	1 1/2	4 3/4	6 3/4	2 3/8	42.1	A	140A23	1 1/2	30.0
24	140B24	14.340	B	1 1/2	4 3/4	6 3/4	2 3/8	46.2	A	140A24	1 1/2	33.0
25	140B25	14.900	B	1 1/2	4 3/4	6 3/4	2 3/8	47.8	A	140A25	1 1/2	34.0
26	140B26	15.460	B	1 1/2	4 3/4	6 3/4	3	57.2	A	140A26	1 1/2	39.0
27	140B27	16.020	B	1 1/2	4 3/4	6 3/4	3	58.5	A	140A27	1 1/2	41.0
28	140B28	16.580	B	1 1/2	4 3/4	6 3/4	3	62.2	A	140A28	1 1/2	45.0
30	140B30	17.700	B	1 1/2	4 3/4	6 3/4	3	69.8	A	140A30	1 1/2	52.0
31		18.260								140A31	1 1/2	56.0
32	140B32	18.820	B	1 1/2	4 3/4	6 3/4	3	76.3	A	140A32	1 1/2	60.0
35	140C35	20.490	C	1 1/2	5 1/4	7	4	108	A	140A35	1 1/2	73.0
36		21.050							A	140A36	1 1/2	77.0
40	140C40	23.290	C	1 1/2	5 1/2	7	4	121	A	140A40	1 1/2	93.0
45	140C45	26.080	C	1 1/2	5 1/2	7	4	142	A	140A45	1 1/2	131
48	140C48	27.750	C	1 1/2	5 1/2	7	4	150	A	140A48	1 1/2	134
54	140C54	31.100	C	1 1/2	5 1/2	7	4	177	A	140A54	1 1/2	173
60	140C60	34.440	C	1 1/2	5 1/2	7	5	220	A	140A60	1 1/2	219
70	140C70	40.020	C	1 1/2	5 1/2	7 1/2	5	282	A	140A70	1 1/2	292
80	140C80	45.590	C	1 1/2	5 1/2	7 1/2	5	331	A	140A80	1 1/2	402

Maximum bores shown will accommodate standard keyseat and setscrew over keyseat. Slightly larger bores are possible with no keyseat, shallow keyseat, or setscrew at angle to keyseat.

Alteration Charges

See current discount sheet for alteration charges.

Single-Type QD With Hardened Teeth

No. Teeth	Catalog Number
11	140SF11 H
12	140SF12 H
13	140SF13 H
14	140E14 H
15	140E15 H
16	140E16 H
17	140E17 H
18	140E18 H
19	140E19 H
20	140E20 H
21	140E21 H
22	140E22 H
23	140F23 H
24	140F24 H
25	140F25 H
26	140F26 H
30	140F30 H

**SABER
TOOTH®**

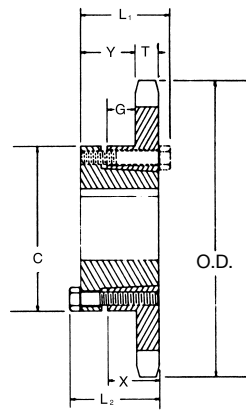

QD — TYPE B

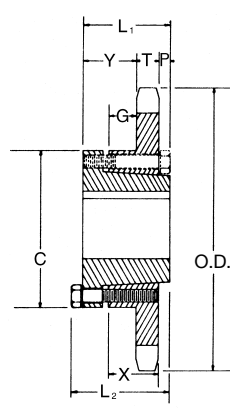

QD — TYPE B₁

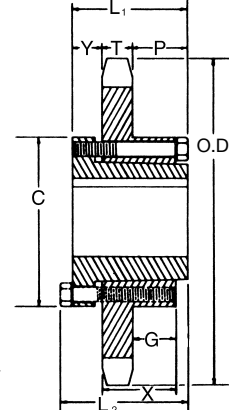

QD — TYPE C

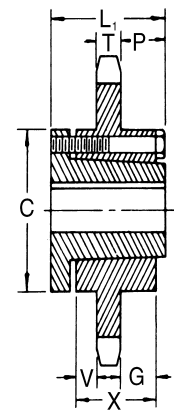

QD — TYPE C₁

SPROCKETS

Single-Type QD

No. Teeth	Catalog Number	Bush- ing	Diameters		Type	Max. Bore	Dimensions									Weight (Approx.)	
			Outside Diameter	Pitch Diameter			L ₁	L ₂	C	Y	P	G	V	X	T	With Hub	Rim Only
11	140SF11	SF	7.010	6.212	B	2 ¹ / ₁₆	2 ¹ / ₄	2 ¹ / ₄	4 ¹ / ₄	1 ¹ / ₄		2 ¹ / ₁₆		1 ¹ / ₄	.924	8.6	5.6
12	140SF12	SF	7.580	6.762	B	2 ¹ / ₁₆	2 ¹ / ₄	2 ¹ / ₄	4 ¹ / ₄	1 ¹ / ₄		2 ¹ / ₁₆		1 ¹ / ₄	.924	10.4	7.4
13	140SF13	SF	8.150	7.313	B	2 ¹ / ₁₆	2 ¹ / ₄	2 ¹ / ₄	4 ¹ / ₄	1 ¹ / ₄		2 ¹ / ₁₆		1 ¹ / ₄	.924	11.9	8.9
14	140E14	E	8.720	7.864	B1	3 ¹ / ₂	2 ⁵ / ₁₆	2 ⁵ / ₁₆	6	1 ¹ / ₁₆	1 ¹ / ₈	4 ⁵ / ₁₆		1 ¹ / ₈	.924	21.6	11.6
15	140E15	E	9.280	8.417	B1											24.2	14.2
16	140E16	E	9.850	8.970	B1											25.9	15.9
17	140E17	E	10.410	9.524	B1											28.0	18.0
18	140E18	E	10.980	10.078	B1											29.6	19.6
19	140E19	E	11.540	10.632	B1											32.0	22.0
20	140E20	E	12.100	11.187	B1											34.6	24.6
21	140E21	E	12.660	11.742	B1											37.6	27.6
22	140E22	E	13.220	12.297	B1	3 ¹ / ₂	2 ⁵ / ₁₆	2 ⁵ / ₁₆	6	1 ¹ / ₁₆	1 ¹ / ₈	4 ⁵ / ₁₆		1 ¹ / ₈	.924	39.5	29.5
23	140F23	F	13.780	12.852	B1	3 ¹ / ₁₆	3 ¹ / ₈	4	6 ¹ / ₈	2 ¹ / ₁₆	1 ¹ / ₈	1 ³ / ₁₆		2 ¹ / ₈	.924	48.0	36.4
24	140F24	F	14.340	13.407	B1											51.6	40.1
25	140F25	F	14.900	13.963	B1											53.8	42.3
26	140F26	F	15.460	14.518	B1											58.0	46.5
30	140F30	F	17.700	16.742	B1	3 ¹ / ₁₆	3 ¹ / ₈	4	6 ¹ / ₈	2 ¹ / ₁₆	1 ¹ / ₈	1 ³ / ₁₆		2 ¹ / ₈	.924	72.0	60.4
35	140F35	F	20.490	19.523	C	3 ¹ / ₁₆	3 ¹ / ₈	4	6 ¹ / ₈	1	1 ¹ / ₁₆	1 ³ / ₁₆		2 ¹ / ₈	.924	89.5	78.0
36	140F36	F	21.050	20.079	C	3 ¹ / ₁₆	3 ¹ / ₈	4	6 ¹ / ₈	1	1 ¹ / ₁₆	1 ³ / ₁₆		2 ¹ / ₈	.924	95.5	84.0
40	140J40	J	23.290	22.305	C	4 ¹ / ₁₆	4 ¹ / ₈	5	7 ¹ / ₄	1 ¹ / ₁₆	2 ¹ / ₈	2 ¹ / ₁₆		3 ¹ / ₁₆	.924	117	98.0
45	140J45	J	26.080	25.087	C											139	120
48	140J48	J	27.750	26.757	C											148	129
54	140J54	J	31.100	30.097	C											168	149
60	140J60	J	34.440	33.438	C	4 ¹ / ₁₆	4 ¹ / ₈	5	7 ¹ / ₄	1 ¹ / ₁₆	2 ¹ / ₈	2 ¹ / ₁₆		3 ¹ / ₁₆	.924	205	186
70	140M70	M	40.020	39.006	C1	5 ¹ / ₂	6 ¹ / ₄	6 ¹ / ₄	9	2 ²⁹ / ₃₂	2 ⁷ / ₃₂	2 ¹⁷ / ₃₂	1 ¹³ / ₃₂	5 ¹ / ₁₆	.924	301	264
80	140M80	M	45.590	44.575	C1	5 ¹ / ₂	6 ¹ / ₄	6 ¹ / ₄	9	2 ²⁹ / ₃₂	2 ⁷ / ₃₂	2 ¹⁷ / ₃₂	1 ¹³ / ₃₂	5 ¹ / ₁₆	.924	385	348

No. 140 1³/₄" Pitch

All Steel Stock Sprockets

Martin

Single-Taper Bushed with Hardened Teeth

No. Teeth	Catalog Number
12	140BTB12 H
13	140BTB13 H
14	140BTB14 H
15	140BTB15 H
16	140BTB16 H
17	140BTB17 H
18	140BTB18 H
19	140BTB19 H
21	140BTB21 H
26	140BTB26 H

**SABER
TOOTH®**

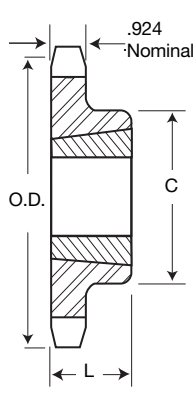

TYPE B

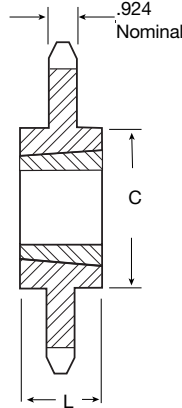

TYPE C



SPROCKETS

Single-Taper Bushed

No. Teeth	Catalog Number	Bushing	Diameter		Max. Bore	Dimensions		Type	Weight (Approx.)	
			Outside Diameter	Pitch Diameter		L	C		Rim Only	Bushing Only
12	140BTB12	2517	7.581	6.762	2 ¹ / ₂	1 ¹ / ₂	4 ¹ / ₂	B	7.0	3.5
13	140BTB13	3020	8.150	7.313	3	2	5 ¹ / ₂	B	8.0	6.5
14	140BTB14	3020	8.718	7.864	3	2	5 ¹ / ₂	B	10.0	6.5
15	140BTB15	3020	9.283	8.417	3	2	5 ¹ / ₂	B	12.0	6.5
16	140BTB16	3020	9.848	8.970	3	2	5 ¹ / ₂	B	14.0	6.5
17	140BTB17	3020	10.411	9.524	3	2	5 ¹ / ₂	B	16.0	6.5
18	140BTB18	3020	10.975	10.078	3	2	5 ¹ / ₂	B	18.0	6.5
19	140BTB19	3020	11.537	10.632	3	2	5 ¹ / ₂	B	20.0	6.5
21	140BTB21	3020	12.660	11.742	3	2	5 ¹ / ₂	B	24.0	6.5
26	140BTB26	3020	15.463	14.518	3	2	5 ¹ / ₂	B	40.0	6.5
35	140CTB35	3535	20.494	19.523	3 ¹ / ₂	3 ¹ / ₂	6 ¹ / ₂	C	78.0	14
45	140CTB45	4040	26.076	25.087	4	4	7 ³ / ₄	C	118.0	22
60	140CTB60	4040	34.442	33.438	4	4	7 ³ / ₄	C	188.0	22
70	140CTB70	4040	40.017	39.006	4	4	7 ³ / ₄	C	241.0	22

Double Single-Type A — Steel

No. Teeth	Catalog Number	Diameters		Type	Min. Bore	Max. Bore	Dimensions			W Nom.	Wt. (Approx.)
		Outside Diameter	Pitch Diameter				L	C	E		
14	DS140A14	8.720	7.864	A	1 ¹ / ₁₆	3 ³ / ₈	3 ³⁹ / ₆₄	2 ¹¹ / ₁₆	5 ⁵ / ₈	.924	35.0
15	DS140A15	9.280	8.417	A	1 ¹ / ₁₆	4 ¹ / ₈	3 ³⁹ / ₆₄	2 ¹¹ / ₁₆	6 ²⁹ / ₆₄	.924	43.0
16	DS140A16	9.850	8.970	A	1 ¹ / ₁₆	5 ¹ / ₄	3 ³⁹ / ₆₄	2 ¹¹ / ₁₆	7 ¹ / ₄	.924	49.0
17	DS140A17	10.410	9.524	A	1 ¹ / ₁₆	5 ⁹ / ₁₆	3 ³⁹ / ₆₄	2 ¹¹ / ₁₆	7 ³ / ₄	.924	58.0
18	DS140A18	10.980	10.078	A	1 ¹ / ₁₆	6 ¹ / ₈	3 ³⁹ / ₆₄	2 ¹¹ / ₁₆	8 ³ / ₄	.924	66.0

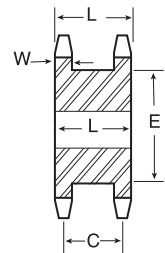

TYPE A

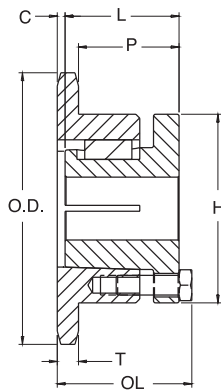

TYPE 4

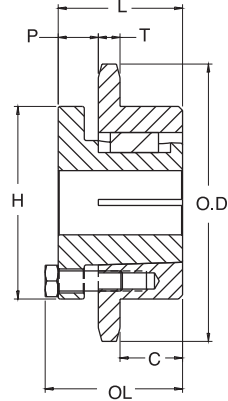

TYPE 5

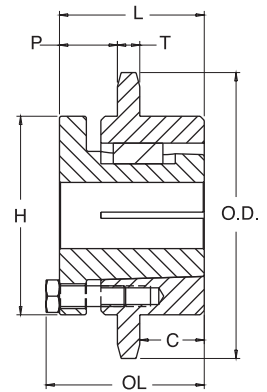

TYPE 6

Single - MST[®] Sprockets

No. Teeth	Catalog Number	Bush-ing	Diameters		Type	Max. Bore	Dimensions						Weight (Approx.)	
			Outside Dia.	Pitch Dia.			OL	L	C	H	P	T(nom)	With Hub	Rim Only
11	140Q11H	Q1	7.010	6.212	4	2-11/16	2-25/32	2-1/2	0	4-1/8	1 9/16	.924	9.9	6.4
12	140Q12H	Q1	7.580	6.762	4	2-11/16	2-25/32	2-1/2	0	4-1/8	1 9/16	.924	12.5	9.0
13	140R13H	R1	8.150	7.313	4	3-3/4	3-5/32	2-7/8	0	5-3/8	1-15/16	.924	18.6	11.1
14	140R14H	R1	8.720	7.864	4	3-3/4	3-5/32	2-7/8	0	5-3/8	1-15/16	.924	20.1	12.6
15	140R15H	R1	9.280	8.417	4	3-3/4	3-5/32	2-7/8	0	5-3/8	1-1/16	.924	22.2	14.7
16	140R16H	R1	9.850	8.970	4	3-3/4	3-5/32	2-7/8	0	5-3/8	1-1/16	.924	24.0	16.5
17	140R17H	R1	10.410	9.524	4	3-3/4	3-5/32	2-7/8	0	5-3/8	1-15/16	.924	26.0	18.5
18	140R18H	R1	10.980	10.078	4	3-3/4	3-5/32	2-7/8	0	5-3/8	1-15/16	.924	28.0	20.5
19	140R19H	R1	11.540	10.632	4	3-3/4	3-5/32	2-7/8	0	5-3/8	1-15/16	.924	30.5	23.0
20	140R20H	R1	12.100	11.187	4	3-3/4	3-5/32	2-7/8	0	5-3/8	1-15/16	.924	32.9	25.4
21	140R21H	R1	12.660	11.742	4	3-3/4	3-5/32	2-7/8	0	5-3/8	1-15/16	.924	35.3	27.8
22	140R22H	R1	13.220	12.297	5	3-3/4	3-5/32	2-7/8	1-1/16	5-3/8	7/8	.924	40.0	32.5
23	140R23H	R1	13.780	12.852	5	3-3/4	3-5/32	2-7/8	1-1/16	5-3/8	7/8	.924	43.5	36.0
24	140R24H	R1	14.340	13.407	5	3-3/4	3-5/32	2-7/8	1-1/16	5-3/8	7/8	.924	45.1	37.6
25	140R25H	R1	14.900	13.963	5	3-3/4	3-5/32	2-7/8	1-1/16	5-3/8	7/8	.924	47.8	40.3
26	140R26H	R1	15.460	14.518	5	3-3/4	3-5/32	2-7/8	1-1/16	5-3/8	7/8	.924	51.5	44.0
30	140R30H	R2	17.700	16.742	5	3-5/8	5-5/32	4-7/8	2	5-3/8	7/8	.924	79.0	68.0
35	140R35	R2	20.490	19.523	6	3-5/8	5-5/32	4-7/8	2	5-3/8	7/8	.924	99.0	88.0
36	140R36	R2	21.050	20.079	6	3-5/8	5-5/32	4-7/8	2	5-3/8	7/8	.924	101.0	90.0
36	140S36	S1	21.050	20.079	5	4-1/4	43/4	4-3/8	2-3/8	6-3/8	1-1/16	.924	102.5	89.0
40	140R40	R2	23.290	22.305	6	3-5/8	5-5/32	4-7/8	2	5-3/8	7/8	.924	120.0	109.0
40	140S40	S1	23.290	22.305	5	4-1/4	4-3/4	4-3/8	2-3/8	6-3/8	1-1/16	.924	120.5	107.0
45	140S45	S1	26.080	25.087	5	4-1/4	4-3/4	43/8	2-3/8	6-3/8	1-1/16	.924	145.5	132.0
48	140S48	S2	27.750	26.757	6	4-3/16	7-1/2	6-3/4	2-7/8	6-3/8	2-15/16	.924	188.0	169.0
54	140S54	S2	31.100	30.097	6	4-3/16	7-1/2	6-3/4	2-7/8	6-3/8	2-15/16	.924	227.0	208.0
60	140S60	S2	34.440	33.438	6	4-3/16	7-1/2	6-3/4	2-7/8	6-3/8	2-15/16	.924	249.0	230.0
70	140S70	S2	40.020	39.006	6	4-3/16	7-1/2	6-3/4	2-7/8	6-3/8	2-15/16	.924	330.0	311.0
80	140S80	S2	45.590	44.575	6	4-3/16	7-1/2	6-3/4	2-7/8	6-3/8	2-15/16	.924	261.0	242.0

Sprockets with "H" suffix have hardened teeth.

No. 140-2

1³/₄" Pitch

All Steel Stock Sprockets

Martin

Double-Type B & C

No. Teeth	Catalog Number	Outside Diameter	Type	Bore (inches)		Hub (inches)		Weight Lbs. (Approx.)
				Stock	Rec. Max.	Dia.	Length Thru	
13	D140B13	8.150	B	1%	3 ⁵ / ₁₆	5	3 ³ / ₄	29
14	D140B14	8.720	B	1%	3%	5 ¹ / ₂	3%	34.8
15	D140B15	9.280	B	1%	4 ¹ / ₂	6 ¹ / ₂	3 ³ / ₄	42.5
16	D140B16	9.850	B	1%	5 ¹ / ₄	7	4	48.1
17	D140B17	10.410	B	1%	5 ¹ / ₄	7	4	57.5
18	D140B18	10.980	B	1%	5 ¹ / ₄	7	4	65.6
19	D140B19	11.540	B	1%	5 ¹ / ₄	7	4	72.0
20	D140B20	12.100	B	1%	5 ¹ / ₄	7	4	76.0
21	D140B21	12.660	B	1%	5 ¹ / ₄	7	4	82.0
22	D140B22	13.220	B	1%	5 ¹ / ₄	7	4	94.0
23	D140B23	13.780	B	1%	5 ¹ / ₄	7	4	100
24	D140B24	14.340	B	1%	5 ¹ / ₄	7	4	104
25	D140B25	14.900	B	1%	5 ¹ / ₄	7	4	120
26	D140B26	15.460	B	1%	5 ¹ / ₄	7	4	128
35	D140C35	20.490	C	1 ¹ / ₂	5%	7 ¹ / ₂	6	180
45	D140C45	26.080	C	1 ¹ / ₂	5%	7 ¹ / ₂	6	232
60	D140C60	34.440	C	1 ¹ / ₂	6%	9 ¹ / ₂	6 ¹ / ₄	372

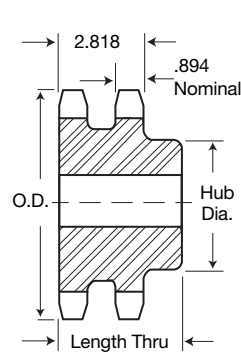

TYPE B

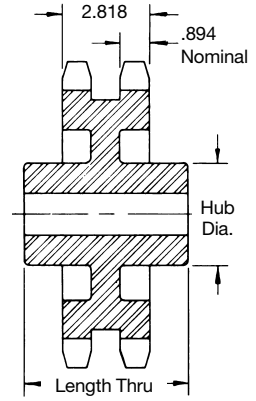

TYPE C

Maximum bores shown will accommodate standard keyseat and setscrew over keyseat. Slightly larger bores are possible with no keyseat, shallow keyseat, or setscrew at angle to keyseat.

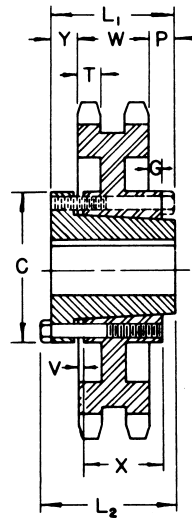

QD — TYPE C₅

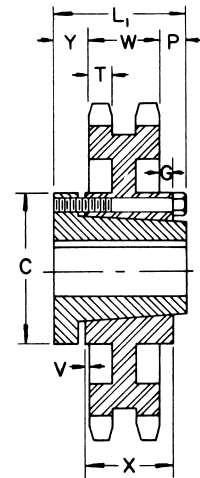

QD — TYPE C₆

Alteration Charges

See current discount sheet for alteration charges.

Double-Type QD

No. Teeth	Catalog Number	Bushing	Diameters		Type	Max. Bore	Dimensions										Weight (Approx.)	
			Outside Diameter	Pitch Diameter			L ₁	L ₂	C	Y	P	G	V	X	T	W	With Hub	Rim Only
35	D140J35	J	20.490	19.523	C5	4 ⁷ / ₁₆	4 ¹ / ₂	5	7 ¹ / ₄	3 ¹ / ₂	2 ³ / ₃₂	1 ⁹ / ₃₂	7 ¹ / ₃₂	3 ³ / ₁₆	.894	2.818	137	128
45	D140J45	J	26.080	25.087	C5	4 ⁷ / ₁₆	4 ¹ / ₂	5	7 ¹ / ₄	3 ¹ / ₂	2 ³ / ₃₂	1 ⁹ / ₃₂	7 ¹ / ₃₂	3 ³ / ₁₆	.894	2.818	195	176
60	D140M60	M	34.440	33.438	C6	5 ¹ / ₂	6%	6%	9	2 ⁷ / ₃₂	1 ²³ / ₃₂	1 ¹⁹ / ₃₂	2 ⁵ / ₃₂	5 ⁵ / ₁₆	.894	2.818	339	302

Single-Type B & C

No. Teeth	Catalog Number	Outside Diameter	Type	Bore (inches)		Hub (inches)		Weight Lbs. (Approx.)	Type	Catalog Number	Stock Bore	Weight Lbs. (Approx.)
				Stock	Rec. Max.	Dia.	Length Thru					
8	160B8	6.030	B	1½	1¾	3¼	2¼	8.0	A	160A8	1½	5.0
9	160B9	6.700	B	1½	2¾	3¾	2¼	10.0	A	160A9	1½	7.0
10	160B10	7.360	B	1½	2¾	4¼	2¼	12.0	A	160A10	1½	8.0
11	160B11	8.010	B	1½	3¾	4¼	2¼	17.0	A	160A11	1½	10.0
12	160B12	8.660	B	1½	3¾	5¼	2¼	21.0	A	160A12	1½	12.0
13	160B13	9.310	B	1½	4	6	2¼	28.0	A	160A13	1½	16.0
14	160B14	9.960	B	1½	4¾	6½	2¼	32.0	A	160A14	1½	17.0
15	160B15	10.610	B	1½	5¼	7	2¼	37.0	A	160A15	1½	21.0
16	160B16	11.260	B	1½	5¼	7	2¼	41.0	A	160A16	1½	24.0
17	160B17	11.900	B	1½	5¼	7	2¼	45.0	A	160A17	1½	27.0
18	160B18	12.540	B	1½	5¼	7	2¼	48.0	A	160A18	1½	30.0
19	160B19	13.190	B	1½	5¼	7	2¼	52.0	A	160A19	1½	34.0
20	160B20	13.830	B	1½	5¼	7	2¼	56.0	A	160A20	1½	38.0
21	160B21	14.470	B	1½	5¼	7	2¼	59.0	A	160A21	1½	42.0
22	160B22	15.110	B	1½	5¼	7	2¼	65.0	A	160A22	1½	46.0
23	160B23	15.750	B	1½	5¼	7	2¼	68.0	A	160A23	1½	50.0
24	160B24	16.390	B	1½	5¼	7	3	77.0	A	160A24	1½	56.0
25	160B25	17.030	B	1½	5¼	7	3	81.0	A	160A25	1½	61.0
26	160B26	17.670	B	1½	5¼	7	3	86.0	A	160A26	1½	65.0
27	160B27	18.310	B	1½	5¼	7	3	91.0	A	160A27	1½	71.0
28	160B28	18.950	B	1½	5¼	7	3	98.0	A	160A28	1½	77.0
30	160B30	20.230	B	1½	5¼	7	3	108	A	160A30	1½	90.0
35	160C35	23.420	C	1½	5¼	8	4½	154	A	160A35	1½	121
40	160C40	26.610	C	1½	5¼	8	4½	196	A	160A40	1½	138
45	160C45	29.800	C	1½	5¼	8	5	234	A	160A45	1½	204
54	160C54	35.540	C	1½	5¼	8	5	276	A	160A54	1½	294
60	160C60	39.360	C	1½	5¼	8	5	329	A	160A60	1½	366
70	160C70	45.730	C	1½	5¼	8	5	446	A	160A70	1½	507
80	160C80	52.100	C	1½	5¼	8	6	612	A	160A80	1½	656

Single-Type C — Steel 2" Pitch

No. Teeth	Catalog Number	Outside Diameter	Bore (inches)		Hub (inches)		Weight Lbs. (Approx.)
			Stock	Rec. Max.	Diameter	Length	
11	160C11	8.010	1½"	3¼"	4½"	4½"	21.0
12	160C12	8.660	1½"	3¼"	5½"	4½"	26.0



Maximum bores shown will accommodate standard keyseat and setscrew over keyseat. Slightly larger bores are possible with no keyseat, shallow keyseat, or setscrew at angle to keyseat.

Single-Type A — Plate

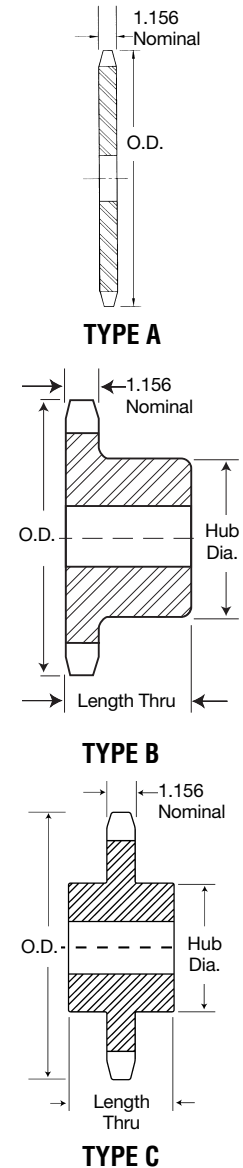

SPROCKETS

Alteration Charges

See current discount sheet for alteration charges.

No. 160 2" Pitch

All Steel Stock Sprockets

Single-Type QD With Hardened Teeth

No. Teeth	Catalog Number
12	160E12 H
13	160E13 H
14	160E14 H
15	160F15 H
16	160F16 H
17	160F17 H
18	160F18 H
19	160F19 H
20	160F20 H
21	160F21 H
22	160F22 H
23	160F23 H
24	160F24 H
25	160F25 H
26	160J26 H
28	160J28 H
30	160J30 H

**SABER
TOOTH®**

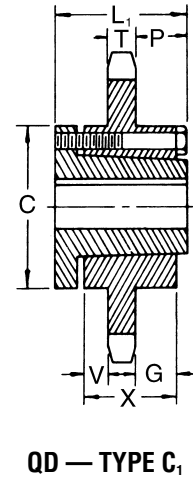
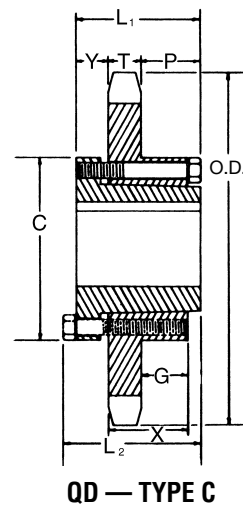
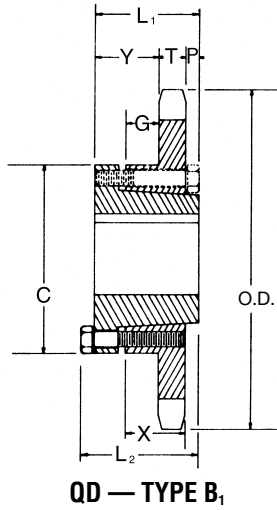

SPROCKETS

Single-Type QD

No. Teeth	Catalog Number	Bush- ing	Diameters		Type	Max. Bore	Dimensions								Weight (Approx.)		
			Outside Diameter	Pitch Diameter			L ₁	L ₂	C	Y	P	G	V	X	T	With Hub	Rim Only
12	160E12	E	8.660	7.727	B1	3½	2%	2 ⁵ / ₁₆	6	1 ¹ / ₁₆	½	1 ¹ / ₂		1%	1.156	21.0	11
13	160E13	E	9.310	8.357	B1	3½	2%	2 ⁵ / ₁₆	6	1 ¹ / ₁₆	½	1 ¹ / ₂		1%	1.156	24.0	14
14	160E14	E	9.960	8.988	B1	3½	2%	2 ⁵ / ₁₆	6	1 ¹ / ₁₆	½	1 ¹ / ₂		1%	1.156	26.0	16
15	160F15	F	10.610	9.620	B1	3 ¹ / ₁₆	3%	4	6%	2 ¹ / ₁₆	½	1 ¹ / ₂		2½	1.156	35.5	24
16	160F16	F	11.260	10.252	B1											38.5	27
17	160F17	F	11.900	10.885	B1											42.5	31
18	160F18	F	12.540	11.518	B1											46.5	35
19	160F19	F	13.190	12.151	B1											49.5	38
20	160F20	F	13.830	12.785	B1											53.5	42
21	160F21	F	14.740	13.419	B1											56.5	45
22	160F22	F	15.110	14.053	B1											62.5	51
23	160F23	F	15.750	14.688	B1											66.5	55
24	160F24	F	16.390	15.323	B1											70.5	59
25	160F25	F	17.030	15.958	B1	3 ¹ / ₁₆	3%	4	6%	2 ¹ / ₁₆	½	1 ¹ / ₂		2½	1.156	75.5	64
26	160J26	J	17.670	16.593	C	4 ¹ / ₁₆	4½	5	7¼	1 ¹ / ₁₆	2%	2 ¹ / ₂		3 ³ / ₁₆	1.156	92.5	74
28	160J28	J	18.950	17.863	C											103	84
30	160J30	J	20.230	19.134	C											115	96
35	160J35	J	23.420	22.312	C	4 ¹ / ₁₆	4½	5	7¼	1 ¹ / ₁₆	2%	2 ¹ / ₂		3 ³ / ₁₆	1.156	135	116
40	160M40	M	26.610	25.491	C1	5½	6%	6%	9	2 ¹ / ₁₆	2 ¹ / ₁₆	2 ¹ / ₂	1 ¹ / ₂	5%	1.156	211	174
45	160M45	M	29.800	28.671	C1											245	208
54	160M54	M	35.540	34.397	C1											299	262
60	160M60	M	39.360	38.215	C1											347	310
70	160M70	M	45.730	44.578	C1											468	431
80	160M80	M	52.100	50.943	C1	5½	6%	6%	9	2 ¹ / ₁₆	2 ¹ / ₁₆	2 ¹ / ₂	1 ¹ / ₂	5%	1.156	567	530

Single-Taper Bushed with Hardened Teeth

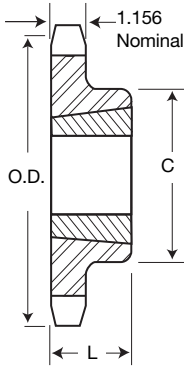

TYPE B

No. Teeth	Catalog Number
11	160BTB11H
12	160BTB12H
13	160BTB13H
14	160BTB14H
15	160BTB15H
16	160BTB16H
17	160BTB17H
18	160BTB18H
19	160BTB19H
21	160BTB21H
26	160BTB26H

**SABER
TOOTH®**

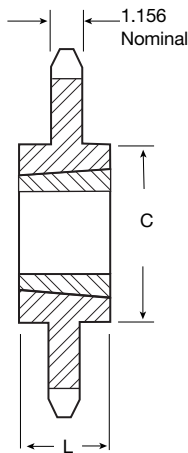

TYPE C

Single-Taper Bushed

No. Teeth	Catalog Number	Bushing	Diameter		Max. Bore	Dimensions		Type	Weight (Approx.)	
			Outside Diameter	Pitch Diameter		L	C		Rim Only	Bushing Only
11	160BTB11	2517	8.011	7.099	2½	1¾	4¾	B	9.0	3.5
12	160BTB12	3020	8.664	7.727	3	2	5¼	B	11.0	6.5
13	160BTB13	3020	9.314	8.357	3	2	5¼	B	13.0	6.5
14	160BTB14	3020	9.963	8.988	3	2	5¼	B	16.0	6.5
15	160BTB15	3535	10.609	9.620	3½	3½	6½	B	25.0	14.0
16	160BTB16	3535	11.255	10.252	3½	3½	6½	B	28.0	14.0
17	160BTB17	3535	11.899	10.885	3½	3½	6½	B	32.0	14.0
18	160BTB18	3535	12.543	11.518	3½	3½	6½	B	35.0	14.0
19	160BTB19	3535	13.185	12.151	3½	3½	6½	B	39.0	14.0
21	160BTB21	3535	14.470	13.419	3½	3½	6½	B	48.0	14.0
26	160BTB26	3535	17.671	16.593	3½	3½	6½	B	68.0	14.0
35	160CTB35	4040	23.422	22.312	4	4	7¾	C	118	14.0
45	160CTB45	4040	29.802	28.671	4	4	7¾	C	186	22.0
60	160CTB60	4545	39.362	38.215	4½	4½	8¾	C	292	30.0

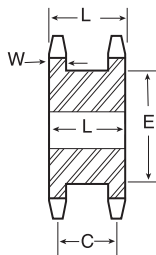

TYPE A

Double Single-Type A — Steel

No. Teeth	Catalog Number	Diameters		Type	Min. Bore	Max. Bore	Dimensions			Wt. (Approx.)	
		Outside Diameter	Pitch Diameter				L	C	E		
15	DS160A15	10.609	9.620	A	1½/16	5½	4¼	3½/32	7¾	1.156	69.0
16	DS160A16	11.255	10.252	A	1½/16	6	4¼	3½/32	8¼	1.156	75.0
17	DS160A17	11.899	10.885	A	1½/16	6½	4¼	3½/32	8¾	1.156	92.0
18	DS160A18	12.543	11.518	A	1½/16	6¾	4¼	3½/32	9¼	1.156	97.0

No. 160 2" Pitch

MST[®] Sprockets

Martin

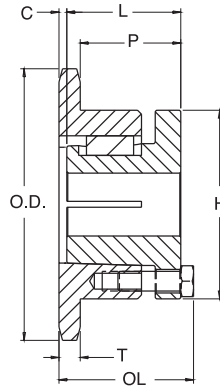

TYPE 4

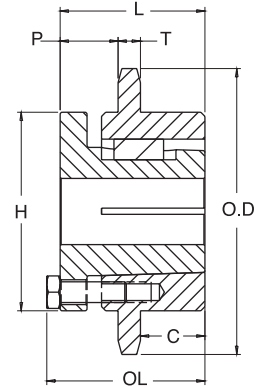

TYPE 6

SPROCKETS

Single - MST[®] Sprockets

No. Teeth	Catalog Number	Bush-ing	Diameters		Type	Max. Bore	Dimensions						Weight (Approx.)	
			Outside Dia.	Pitch Dia.			OL	L	C	H	P	T(nom)	With Hub	Rim Only
11	160R11H	R1	8.010	7.099	4	3-3/4	3-13/32	2-7/8	1/4	5-3/8	1-31/32	1.156	18.3	10.8
12	160R12H	R1	8.660	7.727	4	3-3/4	3-13/32	2-7/8	1/4	5-3/8	1-31/32	1.156	21.7	14.2
13	160R13H	R1	9.310	8.357	4	3-3/4	3-5/32	2-7/8	0	5-3/8	1-23/32	1.156	23.0	15.5
14	160R14H	R1	9.960	8.988	4	3-3/4	3-5/32	2-7/8	0	5-3/8	1-23/32	1.156	26.0	18.5
15	160R15H	R1	10.610	9.620	4	3-3/4	3-5/32	2-7/8	0	5-3/8	1-23/32	1.156	29.1	21.6
16	160R16H	R1	11.260	10.252	4	3-3/4	3-5/32	2-7/8	0	5-3/8	1-23/32	1.156	32.5	25.0
17	160R17H	R1	11.900	10.885	4	3-3/4	3-5/32	2-7/8	0	5-3/8	1-23/32	1.156	35.5	28.0
18	160R18H	R1	12.540	11.518	4	3-3/4	3-5/32	2-7/8	0	5-3/8	1-23/32	1.156	39.4	31.9
19	160R19H	R1	13.190	12.151	4	3-3/4	3-5/32	2-7/8	0	5-3/8	1-23/32	1.156	43.4	35.9
20	160R20H	R2	13.830	12.785	6	3-5/8	5-5/32	4-7/8	2	5-3/8	1-23/32	1.156	62.0	51.0
21	160R21H	R2	14.470	13.419	6	3-5/8	5-5/32	4-7/8	2	5-3/8	1-23/32	1.156	67.0	56.0
22	160R22H	R2	15.110	14.053	6	3-5/8	5-5/32	4-7/8	2	5-3/8	1-23/32	1.156	71.0	60.0
23	160R23H	R2	15.750	14.688	6	3-5/8	5-5/32	4-7/8	2	5-3/8	1-23/32	1.156	76.0	65.0
24	160R24H	R2	16.390	15.323	6	3-5/8	5-5/32	4-7/8	2	5-3/8	1-23/32	1.156	82.5	71.5
25	160R25H	R2	17.030	15.958	6	3-5/8	5-5/32	4-7/8	2	5-3/8	1-23/32	1.156	85.0	74.0
26	160R26H	R2	17.670	16.593	6	3-5/8	5-5/32	4-7/8	2	5-3/8	1-23/32	1.156	90.0	79.0
26	160S26H	S2	17.670	16.593	6	4-3/16	7-1/8	6-3/4	2-7/8	6-3/8	2-23/32	1.156	98.0	79.0
28	160R28H	R2	18.950	17.863	6	3-5/8	5-5/32	4-7/8	2	5-3/8	1-23/32	1.156	110.8	99.8
28	160S28H	S2	19.950	17.863	6	4-3/16	7-1/8	6-3/4	2-7/8	6-3/8	2-23/32	1.156	118.8	99.8
30	160R30H	R2	20.230	19.134	6	3-5/8	5-5/32	4-7/8	2	5-3/8	1-23/32	1.156	117.0	106.0
30	160S30H	S2	20.230	19.134	6	4-3/16	7-1/8	6-3/4	2-7/8	6-3/8	2-23/32	1.156	134.0	115.0
35	160S35	S2	23.420	22.312	6	4-3/16	7-1/8	6-3/4	2-7/8	6-3/8	2-23/32	1.156	169.0	150.0
40	160S40	S2	26.610	25.491	6	4-3/16	7-1/8	6-3/4	2-7/8	6-3/8	2-23/32	1.156	184.0	165.0
45	160S45	S2	29.800	28.671	6	4-3/16	7-1/8	6-3/4	2-7/8	6-3/8	2-23/32	1.156	223.0	204.0
60	160U60	U0	39.360	38.215	6	5-1/2	5 25/32	5-1/4	1-15/16	8-3/8	1-21/32	1.156	338.0	308.0
70	160U70	U0	45.730	44.578	6	5-1/2	5 25/32	5-1/4	1-15/16	8-3/8	1-21/32	1.156	384.0	354.0
80	160S80	S2	52.100	50.943	6	4-3/16	7-1/8	6-3/4	2-7/8	6-3/8	2-23/32	1.156	0	0
80	160U80	U1	52.100	50.943	6	5-1/2	7-19/32	7-1/8	2-7/8	8-3/8	2 19/32	1.156	434.0	394.0

Sprockets with "H" suffix have hardened teeth.

Double-Type B & C

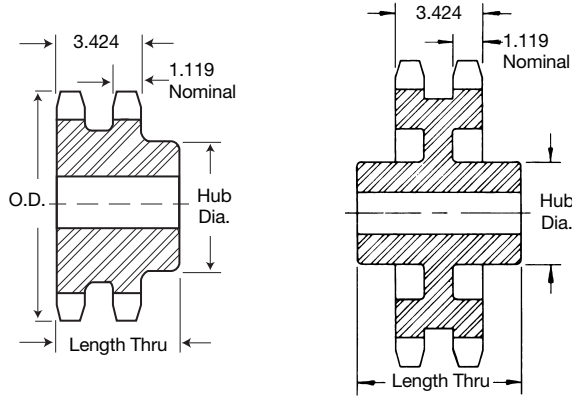

TYPE B

TYPE C

No. Teeth	Catalog Number	Outside Diameter	Type	Bore (inches)		Hub (inches)		Weight Lbs. (App.)
				Stock	Rec. Max.	Dia.	Length Thru	
13	D160B13	9.310	B	2	4	6	4%	48
14	D160B14	9.960	B	2	4%	6%	4%	58
15	D160B15	10.610	B	2	5%	7	4%	68
16	D160B16	11.260	B	2	5%	7	4%	75
17	D160B17	11.900	B	2	5%	7	4%	91
18	D160B18	12.540	B	2	5%	7	4%	96
19	D160B19	13.190	B	2	5%	7	4%	107
20	D160B20	13.830	B	2	5%	7	4%	119
21	D160B21	14.470	B	2	5%	7½	4%	130
22	D160B22	15.110	B	2	5%	7½	4%	141
23	D160B23	15.750	B	2	5%	7½	4%	157
24	D160B24	16.390	B	2	5%	7½	4%	171
25	D160B25	17.030	B	2	5%	7½	4%	187
26	D160B26	17.670	B	2	5%	7½	4%	201
35	D160C35	23.420	C	1½	6%	9%	6%	306
45	D160C45	29.800	C	1½	7	10	7%	431
60	D160C60	39.360	C	1½	7	10	7%	564

Maximum bores shown will accommodate standard keyseat and setscrew over keyseat. Slightly larger bores are possible with no keyseat, shallow keyseat, or setscrew at angle to keyseat.

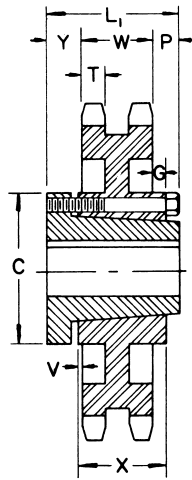

QD — TYPE C₆



Alteration Charges

See current discount sheet for alteration charges.

Double-Type QD

No. Teeth	Catalog Number	Bushing	Diameters		Type	Max. Bore	Dimensions										Weight (Approx.)		
			Outside Diameter	Pitch Diameter			L ₁	L ₂	C	Y	P	G	V	X	T	W	With Hub	Rim Only	
35	D160M35	M	23.420	22.312	C6	5½	6%	6%	6%	9	2½/₄	1½/₂	1½/₂	¾/₄	5/₁₆	1.119	3.424	259	222
45	D160N45	N	29.800	28.671	C6	6	8%	8%	8%	10	2½/₂	2¾/₄	2¾/₂	2½/₂	6%	1.119	3.424	377	340
60	D160N60	N	39.360	38.215	C6	6	8%	8%	8%	10	2½/₂	2¾/₄	2¾/₂	2½/₂	6%	1.119	3.424	509	472

No. 180

2 1/4" Pitch

All Steel Stock Sprockets

Martin

Single-Type B & C

Single-Type A

No. Teeth	Catalog Number	Outside Diameter	Type	Bore (inches)		Hub (inches)		Weight Lbs (Approx.)	Type	Catalog Number	Stock Bore	Weight Lbs. (Approx.)
				Stock	Rec. Max.	Dia.	Length Thru					
11	180B11	9.010	B	1 1/2	3%	5 1/2	3	29	A	180A11	1 1/2	14
12	180B12	9.750	B	1 1/2	4	6	3	32	A	180A12	1 1/2	16
13	180B13	10.480	B	1 1/2	4%	6 1/2	3 1/2	40	A	180A13	1 1/2	20
14	180B14	11.210	B	1 1/2	5%	7	3 1/2	44	A	180A14	1 1/2	24
15	180B15	11.930	B	1 1/2	5%	7	3 1/2	48	A	180A15	1 1/2	28
16	180B16	12.660	B	1 1/2	5%	7	3 1/2	52	A	180A16	1 1/2	32
17	180B17	13.390	B	1 1/2	5%	7	3 1/2	58	A	180A17	1 1/2	37
18	180B18	14.110	B	1 1/2	5%	7	3 1/2	63	A	180A18	1 1/2	43
19	180B19	14.830	B	1 1/2	5%	7 1/2	3 1/2	74	A	180A19	1 1/2	47
20	180B20	15.560	B	1 1/2	5%	7 1/2	3 1/2	81	A	180A20	1 1/2	53
21	180B21	16.280	B	1 1/2	5%	7 1/2	3 1/2	83	A	180A21	1 1/2	57
22	180B22	17.000	B	1 1/2	5%	7 1/2	3 1/2	92	A	180A22	1 1/2	62
23	180B23	17.720	B	1 1/2	5%	7 1/2	3 1/2	99	A	180A23	1 1/2	69
24	180B24	18.440	B	1 1/2	5%	7 1/2	3 1/2	105	A	180A24	1 1/2	77
25	180B25	19.160	B	1 1/2	5%	7 1/2	3 1/2	113	A	180A25	1 1/2	84
28	180B28	21.320	B	1 1/2	5%	8	3 1/2	135	A	180A28	1 1/2	104
30	180C30	22.760	C	1 1/2	5%	8 1/2	4%	180	A	180A30	1 1/2	120
35	180C35	26.350	C	1 1/2	5%	8 1/2	4%	222	A	180A35	1 1/2	172
40	180C40	29.940	C	1 1/2	5%	8 1/2	4%	270	A	180A40	1 1/2	229
45	180C45	33.530	C	1 1/2	6	9	5	315	A	180A45	1 1/2	284
54	180C54	39.980	C	1 1/2	6	9	5	477	A	180A54	1 1/2	420
60	180C60	44.280	C	1 1/2	6 1/2	9 1/2	5%	489	A	180A60	1 1/2	505



SPROCKETS

Maximum bores shown will accommodate standard keyseat and setscrew over keyseat. Slightly larger bores are possible with no keyseat, shallow keyseat, or setscrew at angle to keyseat.

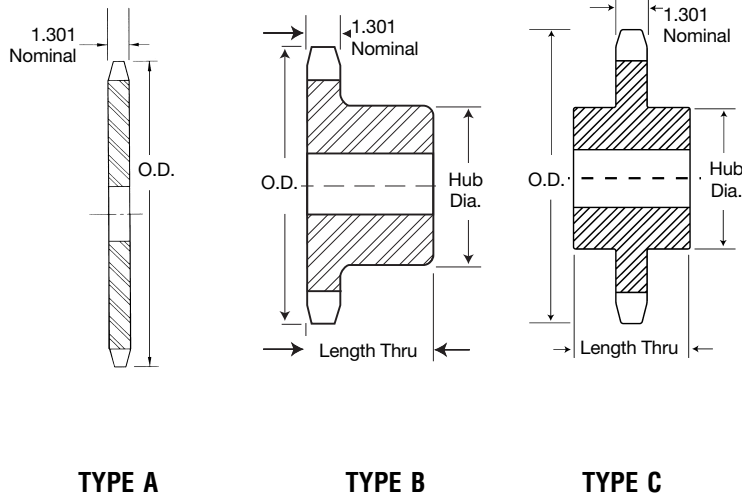

Alteration Charges

See current discount sheet for alteration charges.

Single-Type B & C

Single-Type A

No. Teeth	Catalog Number	Outside Diameter	Type	Bore (inches)		Hub (inches)		Weight Lbs. (Approx.)	Type	Catalog Number	Stock Bore	Weight Lbs. (Approx.)
				Stock	Rec. Max.	Diameter	Length Thru					
10	200B10	9.200	B	1½	3¼	5½	3	26	A	200A10	1½	16
11	200B11	10.020	B	1½	4	6	3	33	A	200A11	1½	20
12	200B12	10.830	B	1½	4½	6½	3	37	A	200A12	1½	24
13	200B13	11.640	B	1½	5¼	7	3	46	A	200A13	1½	30
14	200B14	12.460	B	1½	5½	7½	3½	59	A	200A14	1½	32
15	200B15	13.260	B	1½	5½	7½	3½	64	A	200A15	1½	40
16	200B16	14.070	B	1½	5½	7½	3½	72	A	200A16	1½	46
17	200B17	14.870	B	1½	5½	7½	3½	76	A	200A17	1½	51
18	200B18	15.680	B	1½	5½	7½	3½	84	A	200A18	1½	57
19	200B19	16.480	B	1½	5½	7½	3½	91	A	200A19	1½	65
20	200B20	17.290	B	1½	5½	7½	3½	98	A	200A20	1½	72
21	200B21	18.090	B	1½	5½	7½	3½	106	A	200A21	1½	82
22	200B22	18.890	B	1½	5½	8½	4	131	A	200A22	1½	88
23	200B23	19.690	B	1½	5½	8½	4	136	A	200A23	1½	95
24	200B24	20.490	B	1½	5½	8½	4	142	A	200A24	1½	105
25	200B25	21.290	B	1½	5½	8½	4	153	A	200A25	1½	113
26	200C26	22.090	C	1½	5½	8½	4½	178	A	200A26	1½	124
28	200C28	23.690	C	1½	5½	8½	4½	195	A	200A28	1½	144
30	200C30	25.290	C	1½	5½	8½	4½	212	A	200A30	1½	167
32	200C32	26.880	C	1½	5½	8½	4½	220	A	200A32	1½	195
35	200C35	29.280	C	1½	5½	8½	4½	254	A	200A35	1½	227
40	200C40	33.270	C	1½	6	9	5	320	A	200A40	1½	301
45	200C45	37.250	C	1½	6	9	5	364	A	200A45	1½	390
54	200C54	44.420	C	1½	6½	9½	5½	512	A	200A54	1½	555
60	200C60	49.200	C	1½	6½	9½	5½	654	A	200A60	1½	692

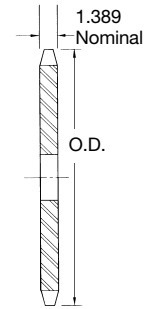

TYPE A

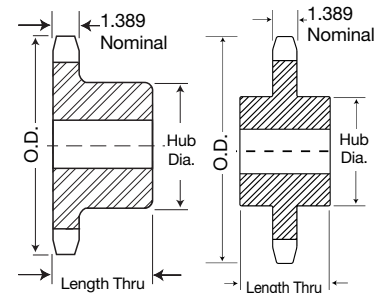

TYPE B

TYPE C

Maximum bores shown will accommodate standard keyseat and setscrew over keyseat. Slightly larger bores are possible with no keyseat, shallow keyseat, or setscrew at angle to keyseat.

Alteration Charges

See current discount sheet for alteration charges.

Single-Type QD

No. Teeth	Catalog Number	Bush-ing	Diameters		Type	Max. Bore	Dimensions										Weight (Approx.)	
			Outside Dia.	Pitch Dia.			L ₁	L ₂	C	Y	P	G	V	X	T	With Hub	Rim Only	
12	200F12	F	10.830	9.660	C	3 ⁵ / ₁₆	3 ³ / ₈	4	6 ⁵ / ₈	1	1 ¹ / ₁₆	1 ¹ / ₁₆		2 ¹ / ₂	1.389	25.5	24	
13	200J13	J	11.640	10.447	C	4 ¹ / ₁₆	4 ¹ / ₂	5	7 ¹ / ₄	1 ¹ / ₁₆	2	1 ¹ / ₁₆		3 ³ / ₁₆	1.389	50.5	32	
14	200J14	J	12.460	11.235	C											57.5	39	
15	200J15	J	13.260	12.025	C											62.5	44	
16	200J16	J	14.070	12.815	C	4 ¹ / ₁₆	4 ¹ / ₂	5	7 ¹ / ₄	1 ¹ / ₁₆	2	1 ¹ / ₁₆		3 ³ / ₁₆	1.389	68.5	50	
17	200M17	M	14.870	13.605	C1	5 ¹ / ₂	6 ³ / ₈	6 ³ / ₈	9	2 ² / ₃₂	2 ² / ₃₂	2 ⁵ / ₁₆	1 ¹ / ₂	5 ⁵ / ₁₆	1.389	113	76	
18	200M18	M	15.680	14.397	C1											119	82	
19	200M19	M	16.480	15.910	C1											125	88	
20	200M20	M	17.290	15.982	C1											134	97	
21	200M21	M	18.090	16.775	C1											140	103	
22	200M22	M	18.890	17.567	C1											149	112	
23	200M23	M	19.690	18.360	C1											157	120	
24	200M24	M	20.490	19.152	C1											168	131	
25	200M25	M	21.290	19.947	C1											175	138	
26	200M26	M	22.090	20.740	C1											185	148	
28	200M28	M	23.690	22.330	C1											205	168	
30	200M30	M	25.290	23.917	C1											227	190	
32	200M32	M	26.880	25.505	C1											251	214	
35	200M35	M	29.280	27.890	C1											265	228	
40	200M40	M	33.270	31.865	C1	5 ¹ / ₂	6 ³ / ₈	6 ³ / ₈	9	2 ² / ₃₂	2 ² / ₃₂	2 ⁵ / ₁₆	1 ¹ / ₂	5 ⁵ / ₁₆	1.389	315	278	
45	200N45	N	37.250	35.840	C1	5 ¹ / ₂	8 ³ / ₈	8 ³ / ₈	10	3 ³ / ₃₂	3 ³ / ₃₂	3 ⁵ / ₁₆	1 ¹ / ₁₆	6 ¹ / ₄	1.389	405	348	
54	200N54	N	44.420	42.995	C1	5 ¹ / ₂	8 ³ / ₈	8 ³ / ₈	10	3 ³ / ₃₂	3 ³ / ₃₂	3 ⁵ / ₁₆	1 ¹ / ₁₆	6 ¹ / ₄	1.389	535	478	
60	200N60	N	49.200	47.767	C1	5 ¹ / ₂	8 ³ / ₈	8 ³ / ₈	10	3 ³ / ₃₂	3 ³ / ₃₂	3 ⁵ / ₁₆	1 ¹ / ₁₆	6 ¹ / ₄	1.389	665	608	

SPROCKETS

No. 200
2 1/2" Pitch

MST[®]
Sprockets

Martin

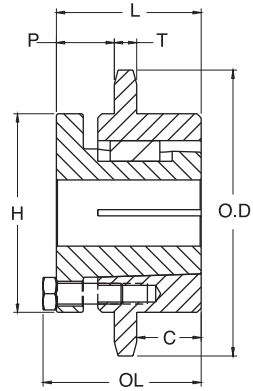

TYPE 6

SPROCKETS

Single - MST[®] Sprockets

No. Teeth	Catalog Number	Bush-ing	Diameters		Type	Max. Bore	Dimensions						Weight (Approx.)	
			Outside Dia.	Pitch Dia.			OL	L	C	H	P	T(nom)	With Hub	Rim Only
12	200R12	R2	10.830	9.660	6	3-5/8	5-5/32	4-7/8	2	5-3/8	1-1/2	1.389	46.3	35.3
13	200S13	S2	11.640	10.447	6	4-3/16	7-1/8	6-3/4	2-7/8	6-3/8	2-1/2	1.389	71.2	52.2
14	200S14	S2	12.460	11.235	6	4-3/16	7-1/8	6-3/4	2-7/8	6-3/8	2-1/2	1.389	76.5	57.5
15	200S15	S2	13.260	12.025	6	4-3/16	7-1/8	6-3/4	2-7/8	6-3/8	2-1/2	1.389	80.0	61.0
16	200S16	S2	14.070	12.815	6	4-3/16	7-1/8	6-3/4	2-7/8	6-3/8	2-1/2	1.389	90.0	71.0
17	200S17	S2	14.870	13.605	6	4-3/16	7-1/8	6-3/4	2-7/8	6-3/8	2-1/2	1.389	98.0	79.0
18	200U18	U0	15.680	14.397	6	5-1/2	5-23/32	5-1/4	1 5/8	8-3/8	2-17/32	1.389	106.5	76.5
19	200U19	U0	16.480	15.190	6	5-1/2	5-23/32	5-1/4	1 5/8	8-3/8	2-17/32	1.389	113.7	83.7
20	200U20	U0	17.290	15.982	6	5-1/2	5-23/32	5-1/4	1 5/8	8-3/8	2-17/32	1.389	121.3	91.3
21	200U21	U0	18.090	16.775	6	5-1/2	5-23/32	5-1/4	1 5/8	8-3/8	2-17/32	1.389	129.4	99.4
22	200U22	U0	18.890	17.567	6	5-1/2	5-23/32	5-1/4	1 5/8	8-3/8	2-17/32	1.389	140.0	110.0
23	200U23	U0	19.690	18.360	6	5-1/2	5-23/32	5-1/4	1 5/8	8-3/8	2-17/32	1.389	147.0	117.0
24	200U24	U0	20.490	19.152	6	5-1/2	5-23/32	5-1/4	1 5/8	8-3/8	2-17/32	1.389	156.0	126.0
25	200U25	U0	21.290	19.947	6	5-1/2	5-23/32	5-1/4	1 5/8	8-3/8	2-17/32	1.389	170.0	140.0
26	200U26	U0	22.090	20.740	6	5-1/2	5-23/32	5-1/4	1 5/8	8-3/8	2-17/32	1.389	180.0	150.0
28	200U28	U0	23.690	22.330	6	5-1/2	5-23/32	5-1/4	1 5/8	8-3/8	2-17/32	1.389	199.0	169.0
30	200U30	U0	25.290	23.917	6	5-1/2	5-23/32	5-1/4	1 5/8	8-3/8	2-17/32	1.389	218.0	188.0
32	200U32	U0	26.880	25.505	6	5-1/2	5-23/32	5-1/4	1 5/8	8-3/8	2-17/32	1.389	242.0	212.0
35	200U35	U1	29.280	27.890	6	5-1/2	7-19/32	7-1/8	2-7/8	8-3/8	2-7/8	1.389	292.0	252.0
40	200U40	U1	33.270	31.865	6	5-1/2	7-19/32	7-1/8	2-7/8	8-3/8	2-7/8	1.389	346.0	306.0
45	200U45	U1	37.250	35.840	6	5-1/2	7-19/32	7-1/8	2-7/8	8-3/8	2-7/8	1.389	330.0	290.0
54	200U54	U2	44.420	42.995	6	5	10-19/32	10-1/8	4-1/4	8-3/8	3-29/32	1.389	435.0	385.0
60	200U60	U2	49.200	47.767	6	5	10-19/32	10-1/8	4-1/4	8-3/8	3-29/32	1.389	495.0	445.0

Sprockets with "H" suffix have hardened teeth.



Double-Type B & C

No. Teeth	Catalog Number	Outside Diameter	Type	Bore (inches)		Hub (inches)		Weight Lbs. (Approx.)
				Stock	Rec. Max.	Dia.	Length Thru	
11	D200B11	10.020	B	2	3½	5½	5½	57
12	D200B12	10.830	B	2	4½	6½	6¼	80
13	D200B13	11.640	B	2	5½	7	6½	96
14	D200B14	12.460	B	2	5½	8	6½	119
15	D200B15	13.260	B	2	5½	8½	6½	138
16	D200B16	14.070	B	2	5½	8½	6½	161
17	D200B17	14.870	B	2	5½	8½	6½	178
18	D200B18	15.680	B	2	5½	8½	6½	196
19	D200B19	16.480	B	2	5½	8½	6½	217
20	D200B20	17.290	B	2	5½	8½	6½	236
21	D200B21	18.090	B	2	5½	8½	6½	250
22	D200B22	18.890	B	2	5½	8½	6½	284
23	D200B23	19.690	B	2	5½	8½	6½	308
24	D200B24	20.490	B	2	5½	8½	6½	330
25	D200B25	21.290	B	2	5½	8½	6½	358
26	D200B26	22.090	B	2	5½	8½	6½	386
45	D200C45	37.250	C	1½	7	10	8½	665
60	D200C60	49.200	C	1½	7	10	9	972

Maximum bores shown will accommodate standard keyseat and setscrew over keyseat. Slightly larger bores are possible with no keyseat, shallow keyseat, or setscrew at angle to keyseat.

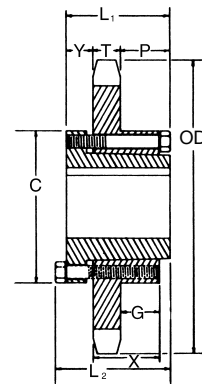

QD — TYPE C

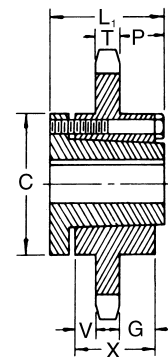

QD — TYPE C1

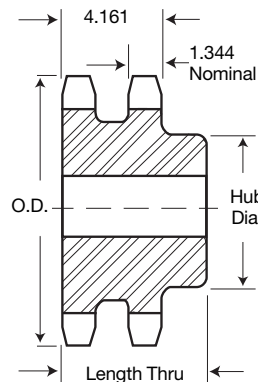

TYPE B

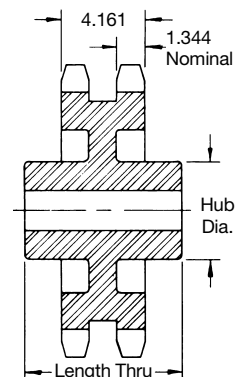

TYPE C

Alteration Charges

See current discount sheet for alteration charges.

No. 240 3" Pitch

All Steel Stock Sprockets



Single-Type B & C

Single-Type A

No. Teeth	Catalog Number	Outside Diameter	Type	Bore (inches)		Hub (inches)		Weight Lbs. (Approx.)	Type	Catalog Number	Stock Bore	Weight Lbs. (Approx.)
				Stock	Rec. Max.	Dia.	Length Thru					
10	240B10	11.030	B	1½	4½	6½	3%	49	A	240A10	1½	30
11	240B11	12.020	B	1½	4¾	7	3%	66	A	240A11	1½	37
12	240B12	13.000	B	1½	5%	7½	3%	72	A	240A12	1½	45
13	240B13	13.970	B	1½	5%	7½	3%	81	A	240A13	1½	54
14	240B14	14.940	B	1½	5%	7½	3%	88	A	240A14	1½	62
15	240B15	15.910	B	1½	5%	7½	3%	98	A	240A15	1½	68
16	240B16	16.880	B	1½	5½	8	4%	120	A	240A16	1½	82
17	240B17	17.850	B	1½	5½	8	4%	137	A	240A17	1½	93
18	240B18	18.810	B	1½	5½	8	4%	142	A	240A18	1½	108
19	240B19	19.780	B	1½	5½	8	4%	154	A	240A19	1½	120
20	240B20	20.740	B	1½	5½	8	4%	169	A	240A20	1½	128
21	240B21	21.710	B	1½	5½	8	4%	186	A	240A21	1½	148
25	240B25	25.550	B	1½	5½	8	4%	254	A	240A25	1½	208
30	240C30	30.340	C	1½	6	9	6%	398	A	240A30	1½	310
35	240C35	35.130	C	1½	6	9	6%	527	A	240A35	1½	416
40	240C40	39.920	C	1½	7	10	6%	672	A	240A40	1½	548
45	240C45	44.700	C	1½	7	10	6%	850	A	240A45	1½	702
54	240C54	53.310	C	1½	7	10	6%	1148	A	240A54	1½	1022
60	240C60	59.040	C	1½	7	10	6%	1419	A	240A60	1½	1268



SPROCKETS

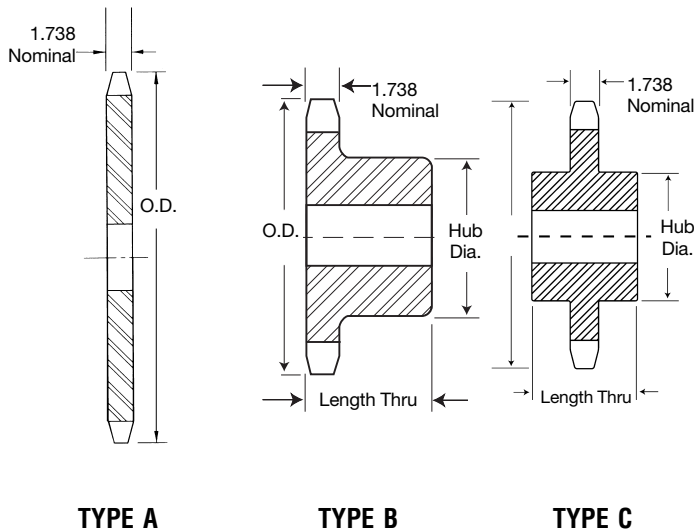

Metric Sprockets ISO STANDARDS

Types A - B & C Stock Sprockets



**TYPE A
SIMPLEX**



**TYPE B
SIMPLEX**



**TYPE C
TRIPLEX**



**TYPE B
DUPLEX**



**Taper Bushed
SIMPLEX**



**Taper Bushed
DUPLEX**



**INSTANT
SPLIT® SPROCKET**

Made-to-Order



**Taper Bushed
DOUBLE-SIMPLEX
HARDENED TEETH
Double Simplex**



**QD
SIMPLEX
“QD” Sprockets**



**IDLER
BALL BEARING
Idler Sprockets**



**TYPE B
SIMPLEX
STAINLESS
Stainless Steel**

Metric Sprockets



0.375 INCH (9.525mm) PITCH **SIMPLEX**

ISO **06B-1**
METRIC **35**

CHAIN DATA:
BS 228/3
ISO 06B-1
PITCH: 9.53mm (0.375 in.)
ROLLER DIAMETER: 6.35mm (0.250 in.)
ROLLER WIDTH: 5.72mm (0.225 in.)
TENSILE: 910 kilos (2000 lbs.)

Simplex-Type B — Steel

Simplex-Type A — Steel

No. Teeth	Pitch Diameter MM	Catalog Number	Bore		Hub		Weight (Approx.) Kilos	Catalog Number	Bore Stock MM	Weight (Approx.) Kilos
			Stock MM	Max. MM	Dia. MM	Thru MM				
8	24.89	06B8	8	9	13	22	0.03			
9	27.85	06B9	8	11	16	22	0.04			
10	30.82	06B10	8	12	20	22	0.06			
11	33.81	06B11	8	14	23	25	0.09			
12	36.80	06B12	8	16	26	25	0.10			
13	39.80	06B13	10	18	29	25	0.11			
14	42.80	06B14	10	16	31	25	0.12			
15	45.81	06B15	10	20	34	25	0.14	06A15	8	0.07
16	48.82	06B16	10	22	37	25	0.18	06A16	10	0.08
17	51.84	06B17	10	25	40	28	0.20	06A17	10	0.18
18	54.85	06B18	10	25	43	28	0.23	06A18	10	0.11
19	57.87	06B19	10	28	46	28	0.25	06A19	10	0.12
20	60.89	06B20	10	30	49	28	0.31	06A20	10	0.13
21	63.91	06B21	12	30	50	28	0.36	06A21	10	0.14
22	66.93	06B22	12	32	51	28	0.37	06A22	10	0.15
23	69.95	06B23	12	32	52	28	0.39	06A23	10	0.17
24	72.97	06B24	12	32	54	28	0.40	06A24	10	0.19
25	76.00	06B25	12	35	57	28	0.41	06A25	10	0.20
26	79.02	06B26	12	38	60	28	0.42	06A26	10	0.21
27	82.05	06B27	12	38	60	28	0.44	06A27	10	0.22
28	85.07	06B28	12	38	60	28	0.45	06A28	10	0.23
29	88.10	06B29	12	38	60	28	0.47	06A29	10	0.25
30	91.12	06B30	12	38	60	30	0.48	06A30	10	0.27
32	97.18	06B32	14	40	65	30	0.56	06A32	12	0.20
35	106.26	06B35	14	40	65	30	0.68	06A35	12	0.27
36	109.29	06B36	16	45	70	30	0.71	06A36	12	0.28
38	115.35	06B38	16	45	70	30	0.77	06A38	14	0.43
40	121.40	06B40	16	45	70	30	0.81	06A40	14	0.45
42	127.46	06B42	16	45	70	30	0.85	06A42	14	0.48
45	136.55	06B45	16	45	75	30	0.91	06A45	14	0.51
48	145.64	06B48	16	45	75	30	0.97	06A48	14	0.54
54	163.82	06B54	16	45	75	30	1.09	06A54	14	0.61
57	172.91	06B57	19	45	75	30	1.27	06A57	18	0.86
60	182.00	06B60	19	45	75	30	1.34	06A60	18	0.91
64	194.12	06B64	19	45	75	30	1.43	06A64	18	0.97
70	212.30	06B70	19	45	75	30	1.56	06A70	18	1.06
72	218.37	06B72	19	45	75	30	1.60	06A72	18	1.09
76	230.49	06B76	19	45	75	30	1.91	06A76	18	1.45
80	242.61	06B80	19	45	75	30	2.01	06A80	18	1.53
84	254.74	06B84	19	45	75	30	2.11	06A84	18	1.60
90	272.93	06B90	19	52	75	30	2.26	06A90	18	1.72
95	288.08	06B95	19	52	75	30	2.61	06A95	18	2.18
96	291.11	06B96	19	52	75	30	2.64	06A96	18	2.20
114	345.68	06B114	19	52	75	30	3.63	06A114	18	3.13

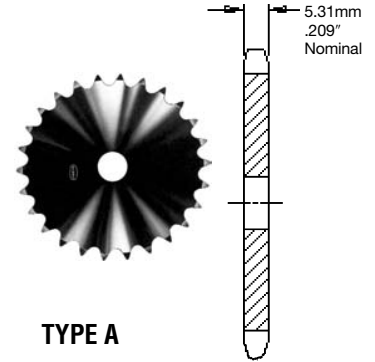

TYPE A

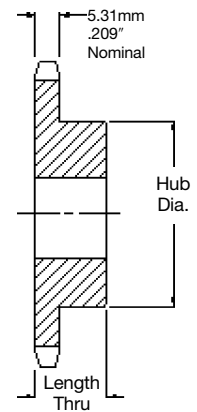

TYPE B

Maximum bores shown will accommodate standard keyseat and setscrew over keyseat. Slightly larger bores are possible with no keyseat, shallow keyseat, or setscrew at angle to keyseat.

SPROCKETS

0.375 INCH (9.525mm) PITCH **SIMPLEX**

ISO **06B-1**
METRIC **35**

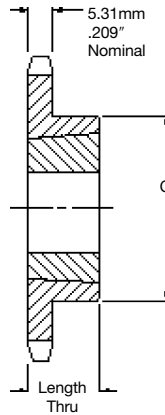
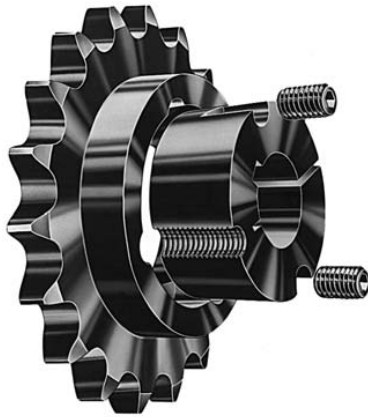

CHAIN DATA:

BS 228/3
ISO 06B-1
PITCH: 9.53mm (0.375 in.)
ROLLER DIAMETER: 6.35mm (0.250 in.)
ROLLER WIDTH: 5.72mm (0.225 in.)
TENSILE: 910 kilos (2000 lbs.)

Simplex-Taper Bushed — Steel

No. Teeth	Pitch Diameter	Catalog Number	Bushing Number	Bore Max. MM	Dimension		Weight	
	MM				L MM	C MM	Rim Kilos	Bushing Kilos
18	54.85	06BTB18H	1008	25.40	22.23	47.63*	0.18	0.14
19	57.87	06BTB19H	1008	25.40	22.23	46.04	0.23	0.14
20	60.89	06BTB20H	1008	25.40	22.23	49.20	0.27	0.14
21	63.91	06BTB21H	1008	25.40	22.23	52.39	0.32	0.14
22	66.93	06BTB22H	1210	31.75	25.40	60.33	0.36	0.27
23	69.95	06BTB23H	1210	31.75	25.40	61.91	0.41	0.27
24	72.97	06BTB24H	1210	31.75	25.40	61.91	0.41	0.27
25	76.00	06BTB25H	1210	31.75	25.40	61.91	0.54	0.27
26	79.02	06BTB26H	1610	41.28	25.40	73.03*	0.50	0.41
28	85.07	06BTB28H	1610	41.28	25.40	73.03	0.54	0.41
30	91.12	06BTB30H	1610	41.28	25.40	79.38	0.54	0.41
32	97.18	06BTB32	1610	41.28	25.40	82.55	0.59	0.41
35	106.26	06BTB35	1610	41.28	25.40	82.55	0.64	0.41
36	109.29	06BTB36	1610	41.28	25.40	82.55	0.64	0.41
38	115.35	06BTB38	1610	41.28	25.40	82.55	0.68	0.41
40	121.40	06BTB40	1610	41.28	25.40	82.55	0.86	0.41
45	136.55	06BTB45	1610	41.28	25.40	82.55	0.95	0.41
48	145.65	06BTB48	1610	41.28	25.40	82.55	1.04	0.41
54	163.82	06BTB54	1610	41.28	25.40	82.55	1.18	0.41
57	172.91	06BTB57	1610	41.28	25.40	82.55	1.25	0.41
60	182.00	06BTB60	1610	41.28	25.40	82.55	1.36	0.41
70	212.30	06BTB70	1610	41.28	25.40	82.55	1.68	0.41
76	230.49	06BTB76	1610	41.28	25.40	82.55	1.82	0.41
95	288.08	06BTB95	1610	41.28	25.40	82.55	2.28	0.41

*Has recessed groove in hub for chain clearance.
Sprockets with "H" suffix have hardened teeth.

Metric Sprockets



ISO **06B-2**
METRIC **35-2**

0.375 INCH (9.525mm) PITCH **DUPLEX** WIDTH CHAIN

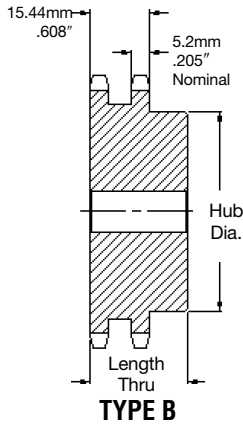

CHAIN DATA:
BS 228/3
ISO 06B-2
PITCH: 9.53mm (0.375 in.)
ROLLER DIAMETER: 6.35mm (0.250 in.)
ROLLER WIDTH: 5.72mm (0.225 in.)
TENSILE: 1730 kilos (3800 lbs.)

SPROCKETS

Duplex-Type B — Steel

No. Teeth	Pitch Diameter MM	Catalog Number	Bore		Hub		Weight (Approx.) Kilos
			Stock MM	Max. MM	Dia. MM	Thru MM	
12	36.80	D06B12	10	16	25	25	0.16
13	39.79	D06B13	10	18	28	25	0.20
14	42.80	D06B14	10	18	31	25	0.25
15	45.81	D06B15	10	20	34	25	0.29
16	48.82	D06B16	12	20	37	30	0.34
17	51.83	D06B17	12	24	40	30	0.39
18	54.85	D06B18	12	25	43	30	0.45
19	57.87	D06B19	12	28	46	30	0.52
20	60.89	D06B20	12	30	49	30	0.59
21	63.91	D06B21	12	30	52	30	0.68
22	66.93	D06B22	12	35	55	30	0.75
23	69.95	D06B23	12	38	58	30	0.80
24	72.97	D06B24	12	39	61	30	0.84
25	76.00	D06B25	12	40	64	30	0.89
26	79.02	D06B26	12	42	67	30	0.91
27	82.05	D06B27	12	45	70	30	1.00
28	85.07	D06B28	12	48	73	30	1.07
29	88.10	D06B29	12	50	76	30	1.14
30	91.12	D06B30	12	52	80	30	1.22
32	98.18	D06B32	16	52	80	30	1.30
35	106.26	D06B35	16	52	80	30	1.42
36	109.29	D06B36	16	60	90	30	1.58
38	115.35	D06B38	16	60	90	30	1.72
40	121.40	D06B40	16	52	80	35	1.81
42	127.46	D06B42	19	60	90	35	2.05
45	136.55	D06B45	19	60	90	35	2.35
48	145.64	D06B48	19	60	90	35	2.75
52	157.75	D06B52	19	60	90	35	3.13
57	172.91	D06B57	19	60	90	35	3.47
60	182.00	D06B60	19	60	90	35	3.78
68	206.24	D06B68	19	60	90	35	4.43
70	212.30	D06B70	19	60	90	35	4.56
72	218.37	D06B72	19	60	90	35	4.89
76	230.49	D06B76	19	60	90	38	5.67
84	254.74	D06B84	19	60	90	38	7.10
95	288.08	D06B95	25	62	95	38	8.64
96	291.11	D06B96	25	62	95	38	8.75
114	345.68	D06B114	25	62	95	38	11.12

Maximum bores shown will accommodate standard keyseat and setscrew over keyseat. Slightly larger bores are possible with no keyseat, shallow keyseat, or setscrew at angle to keyseat.

ISO **06B-2**
METRIC **35-2**

0.375 INCH (9.525mm) PITCH **DUPLEX WIDTH CHAINS**

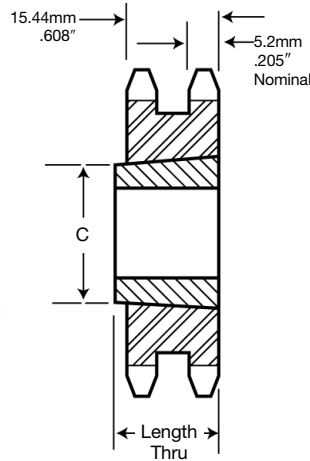
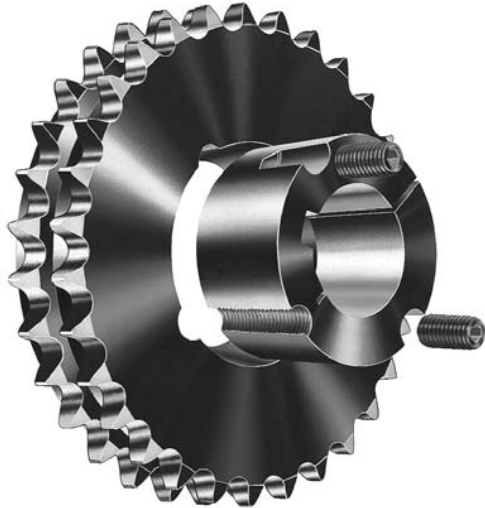

CHAIN DATA:

BS 228/3
ISO 06B-2
PITCH: 9.53mm (0.375 in.)
ROLLER DIAMETER: 6.35mm (0.250 in.)
ROLLER WIDTH: 5.72mm (0.225 in.)
TENSILE: 1730 kilos (3800 lbs.)

Duplex-Taper Bushed — Steel

No. Teeth	Pitch Diameter	Catalog Number	Bushing Number	Bore Max.	Dimension		Weight	
	MM				L	C	Rim	Bushing
				MM	MM	MM	Kilos	Kilos
19	57.87	D06BTB19	1008	25.40	22.23	46.43	0.6	0.14
20	60.89	D06BTB20	1008	25.40	22.23	49.20	0.8	0.14
21	63.91	D06BTB21	1008	25.40	22.23	52.39	1.4	0.14
22	66.93	D06BTB22	1008	25.40	22.23	55.56	1.7	0.14
24	72.97	D06BTB24	1210	31.75	25.40	61.91	1.8	0.27
25	76.00	D06BTB25	1210	31.75	25.40	61.91	1.9	0.27
26	79.02	D06BTB26	1210	31.75	25.40	66.68	2.0	0.27
30	91.12	D06BTB30	1610	41.28	25.40	79.38	1.8	0.41
32	97.18	D06BTB32	1610	41.28	25.40	82.55	2.0	0.41
35	106.26	D06BTB35	1610	41.28	25.40	82.55	2.3	0.41
38	115.34	D06BTB38	1610	41.28	25.40	82.55	2.5	0.41
40	121.40	D06BTB40	1610	41.28	25.40	82.55	2.9	0.41
45	136.55	D06BTB45	1610	41.28	25.40	82.55	3.2	0.41
48	145.65	D06BTB48	1610	41.28	25.40	92.08	3.5	0.41
54	163.82	D06BTB54	1610	41.28	25.40	92.08	3.9	0.41
57	172.91	D06BTB57	1610	41.28	25.40	92.08	4.1	0.41
60	182.00	D06BTB60	1610	41.28	25.40	92.08	4.9	0.41
70	212.30	D06BTB70	1610	41.28	25.40	92.08	6.3	0.41
76	230.49	D06BTB76	1610	41.28	25.40	92.08	6.8	0.41
95	288.08	D06BTB95	1610	41.28	25.40	92.08	6.9	0.41

Metric Sprockets

0.375 INCH (9.525mm) PITCH TRIPLEX

ISO 06B-3
METRIC 35-3

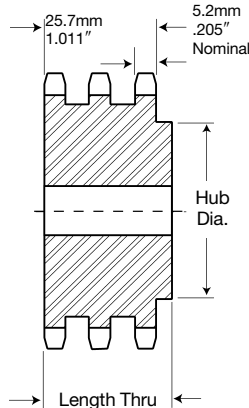

TYPE B

CHAIN DATA:

BS 228/3
ISO 06B-3
PITCH: 9.53mm (0.375 in.)
ROLLER DIAMETER: 6.35mm (0.250 in.)
ROLLER WIDTH: 5.72mm (0.225 in.)
TENSILE: 2540 kilos (5600 lbs.)

SPROCKETS

Triplex-Type B — Steel

No. Teeth	Pitch Diameter MM	Catalog Number	Bore		Hub		Weight (Approx.) Kilos
			Stock	Max.	Dia.	Thru	
			MM	MM	MM	MM	
12	36.80	E06B12	12	16	25	35	0.23
13	39.80	E06B13	12	18	28	35	0.27
14	42.80	E06B14	12	18	31	35	0.32
15	45.81	E06B15	12	20	34	35	0.36
16	48.82	E06B16	12	20	37	35	0.45
17	51.84	E06B17	12	24	40	35	0.54
18	54.85	E06B18	12	25	43	35	0.64
19	57.87	E06B19	12	28	46	35	0.72
20	60.89	E06B20	12	30	49	35	0.77
21	63.91	E06B21	14	30	52	40	0.86
22	66.93	E06B22	14	35	54	40	0.95
23	69.95	E06B23	14	38	58	40	1.04
24	72.97	E06B24	14	39	61	40	1.18
25	76.00	E06B25	14	40	64	40	1.27
26	79.02	E06B26	14	42	67	40	1.31
27	82.05	E06B27	14	45	70	40	1.36
28	85.07	E06B28	14	48	73	40	1.50
29	88.10	E06B29	14	50	76	40	1.68
30	91.12	E06B30	14	52	80	40	1.72
32	97.18	E06B32	16	52	80	48	2.00
35	106.26	E06B35	16	52	80	48	2.25
36	109.29	E06B36	16	60	90	40	2.33
38	115.34	E06B38	16	60	90	40	2.49
40	121.40	E06B40	16	52	80	48	2.65
42	127.46	E06B42	19	60	90	48	2.81
45	136.55	E06B45	19	60	90	48	3.00
48	145.64	E06B48	19	60	90	48	3.20
52	157.75	E06B52	19	60	90	48	3.46
57	172.91	E06B57	19	60	90	48	4.77
60	182.00	E06B60	19	60	80	48	5.02
68	206.24	E06B68	19	60	90	48	5.69
72	218.37	E06B72	19	60	90	48	6.02
76	230.49	E06B76	19	64	100	48	8.48
84	254.74	E06B84	19	64	100	48	9.37
95	288.08	E06B95	25	64	100	54	13.61
96	291.11	E06B96	25	64	100	54	13.75
114	345.68	E06B114	25	64	100	54	17.48



Metric Sprockets

ISO **08B-1**
METRIC **40**

0.500 INCH (12.70mm) PITCH **SIMPLEX**

CHAIN DATA:
BS 228/7
ISO 08B-1
PITCH: 12.70mm (0.500 in.)
ROLLER DIAMETER: 8.51mm (0.335 in.)
ROLLER WIDTH: 7.75mm (0.305 in.)
TENSILE: 1820 kilos (4000 lbs.)

Simplex-Type A — Steel

Simplex-Type B — Steel

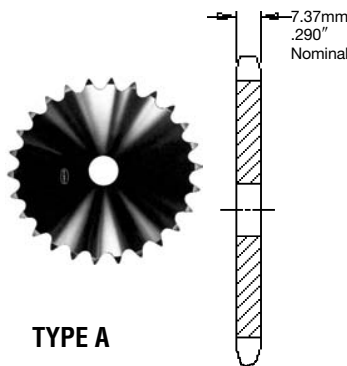

TYPE A

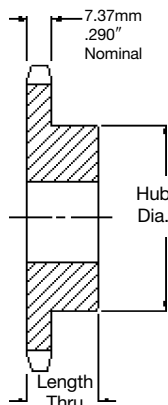

TYPE B



No. Teeth	Pitch Diameter MM	Catalog Number	Bore		Hub		Weight (Approx.) Kilos	Catalog Number	Bore Stock MM	Weight (Approx.) Kilos
			Stock MM	Max. MM	Dia. MM	Thru MM				
9	37.13	08B9	10	15	21	25	0.14			
10	41.10	08B10	10	20	26	25	0.15			
11	45.08	08B11	10	22	30	25	0.17			
12	49.07	08B12	10	22	34	28	0.24	08A12	10	0.08
13	53.07	08B13	10	25	38	28	0.25	08A13	10	0.1
14	57.07	08B14	10	28	42	28	0.31	08A14	10	0.12
15	61.08	08B15	10	30	46	28	0.33	08A15	10	0.14
16	65.10	08B16	12	32	50	28	0.37	08A16	10	0.15
17	69.12	08B17	12	35	54	28	0.51	08A17	10	0.16
18	73.14	08B18	12	38	57	28	0.54	08A18	10	0.2
19	77.16	08B19	12	40	64	28	0.65	08A19	10	0.21
20	81.18	08B20	12	42	67	28	0.76	08A20	10	0.25
21	85.21	08B21	12	45	70	28	0.82	08A21	12	0.26
22	89.24	08B22	12	48	73	28	0.88	08A22	12	0.3
23	93.27	08B23	12	51	78	28	1.05	08A23	12	0.33
24	97.30	08B24	14	53	82	28	1.05	08A24	12	0.37
25	101.33	08B25	14	53	82	28	1.13	08A25	12	0.4
26	105.36	08B26	16	53	82	30	1.15	08A26	16	0.43
27	109.40	08B27	16	53	82	30	1.19	08A27	16	0.44
28	113.43	08B28	16	53	82	30	1.30	08A28	16	0.5
29	117.46	08B29	16	53	82	30	1.33	08A29	16	0.55
30	121.50	08B30	16	53	89	30	1.36	08A30	15	0.57
31	125.53	08B31	16	60	89	30	1.41	08A31	15	0.64
32	129.57	08B32	16	60	89	30	1.46	08A32	15	0.67
33	133.61	08B33	16	60	89	30	1.51	08A33	15	0.71
34	137.64	08B34	16	60	89	30	1.56	08A34	15	0.74
35	141.68	08B35	16	60	89	30	1.61	08A35	15	0.77
36	145.72	08B36	16	60	89	35	1.69	08A36	15	0.83
37	149.75	08B37	16	60	89	35	1.74	08A37	15	0.87
38	153.79	08B38	16	60	89	35	1.78	08A38	15	0.91
39	157.83	08B39	19	60	89	35	1.83	08A39	18	0.92
40	161.87	08B40	19	60	89	35	1.88	08A40	18	1.01
42	169.94	08B42	19	60	89	35	1.97	08A42	18	1.13
45	182.06	08B45	19	60	89	35	2.11	08A45	18	1.43
48	194.18	08B48	19	64	100	35	2.76	08A48	18	1.46
54	218.42	08B54	19	64	100	35	3.11	08A54	18	2.01
57	230.54	08B57	19	64	100	35	3.28	08A57	18	2.27
60	242.66	08B60	19	64	100	35	3.45	08A60	18	2.03
64	258.83	08B64	19	64	100	35	3.68	08A64	18	2.17
70	283.07	08B70	19	64	100	35	4.02	08A70	18	3.28
72	291.15	08B72	19	64	100	35	4.13	08A72	18	3.51
76	307.32	08B76	19	64	100	35	5.73	08A76	18	3.70
80	323.49	08B80	19	64	100	35	6.03	08A80	18	4.63
84	339.65	08B84	19	64	100	35	6.33	08A84	18	4.57
95	384.11	08B95	25	64	100	35	8.90	08A95	24	5.45
96	388.15	08B96	25	64	100	35	8.99	08A96	24	5.51
114	460.91	08B114	25	64	100	35	11.17	08A114	24	6.54

Maximum bores shown will accommodate standard keyseat and setscrew over keyseat. Slightly larger bores are possible with no keyseat, shallow keyseat, or setscrew at angle to keyseat.

SPROCKETS

Metric Sprockets

0.500 INCH (12.70mm) PITCH **SIMPLEX**

ISO **08B-1**
METRIC **40**

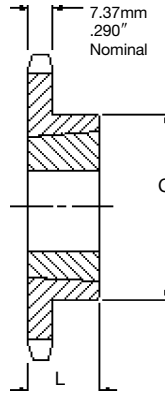

TYPE B

CHAIN DATA:

BS 228/7
ISO 08B-1
PITCH: 12.70mm (0.500 in.)
ROLLER DIAMETER: 8.51mm (0.335 in.)
ROLLER WIDTH: 7.75mm (0.305 in.)
TENSILE: 1820 kilos (4000 lbs.)

SPROCKETS

Simplex-Taper Bushed — Steel

No. Teeth	Pitch Diameter	Catalog Number	Bushing Number	Bore Max.	Dimension		Weight	
	MM			MM	L	C	Rim	Bushing
				MM	MM	MM	Kilos	Kilos
14	57.07	08BTB14H	1008	25.40	22.23	46*	0.18	0.14
15	61.08	08BTB15H	1008	25.40	22.23	46	0.18	0.14
16	65.10	08BTB16H	1008	25.40	22.23	46	0.23	0.14
17	69.12	08BTB17H	1210	31.75	25.40	60*	0.23	0.14
18	73.14	08BTB18H	1210	31.75	25.40	62*	0.27	0.27
19	77.16	08BTB19H	1210	31.75	25.40	62	0.32	0.27
20	81.18	08BTB20H	1610	41.28	25.40	70*	0.41	0.41
21	85.21	08BTB21H	1610	41.28	25.40	70	0.45	0.41
22	89.24	08BTB22H	1610	41.28	25.40	70	0.50	0.41
23	93.27	08BTB23H	1610	41.28	25.40	76	0.59	0.41
24	97.30	08BTB24H	1610	41.28	25.40	82	0.73	0.41
25	101.33	08BTB25H	1610	41.28	25.40	82	0.73	0.41
26	105.36	08BTB26H	1610	41.28	25.40	82	0.73	0.41
27	109.40	08BTB27H	1610	41.28	25.40	76	0.70	0.41
28	113.43	08BTB28H	1610	41.28	25.40	76	0.73	0.41
29	117.46	08BTB29H	1610	41.28	25.40	76	0.76	0.41
30	121.50	08BTB30H	1610	41.28	25.40	73	0.82	0.41
32	129.57	08BTB32	1610	41.28	25.40	76	0.87	0.41
35	141.68	08BTB35	1610	41.28	25.40	76	0.96	0.41
36	145.72	08BTB36	1610	41.28	25.40	76	0.98	0.41
38	153.79	08BTB38	1610	41.28	25.40	76	1.23	0.41
40	161.87	08BTB40	1610	41.28	25.40	76	1.29	0.41
42	169.94	08BTB42	1610	41.28	25.40	76	1.36	0.41
45	182.06	08BTB45	1610	41.28	25.40	76	1.46	0.41
48	194.18	08BTB48	1610	41.28	25.40	76	1.55	0.41
54	218.42	08BTB54	1610	41.28	25.40	76	1.75	0.41
57	230.54	08BTB57	1610	41.28	25.40	76	2.63	0.41
60	242.66	08BTB60	1610	41.28	25.40	76	2.77	0.41
70	283.07	08BTB70	2012	50.80	31.75	90	3.93	0.41
72	291.15	08BTB72	2012	50.80	31.75	90	4.05	0.41
76	307.32	08BTB76	2012	50.80	31.75	90	4.27	0.77
80	323.49	08BTB80	2012	50.80	31.75	90	4.49	0.77
84	339.65	08BTB84	2012	50.80	31.75	90	4.72	0.77
95	384.11	08BTB95	2012	50.80	31.75	90	6.81	0.77
96	388.15	08BTB96	2012	50.80	31.75	90	6.88	0.77
114	460.91	08BTB114	2517	63.50	44.45	108	10.44	0.77

* Has recessed groove in hub for chain clearance.
Sprockets with "H" suffix have hardened teeth.

0.500 INCH (12.70mm) PITCH DUPLEX

ISO **08B-2**
METRIC **40-2**

CHAIN DATA:

BS 228/7

ISO 08B-2

PITCH: 12.70mm (0.500 in.)

ROLLER DIAMETER: 8.51mm (0.335 in.)

ROLLER WIDTH: 7.75mm (0.305 in.)

TENSILE: 3180 kilos (7000 lbs.)

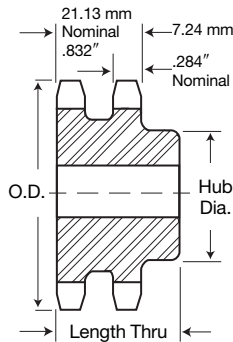

TYPE B

Duplex-Type B — Steel

No. Teeth	Pitch Diameter MM	Catalog Number	Bore		Hub		Weight (Approx.) Kilos
			Stock MM	Max. MM	Dia. MM	Thru MM	
10	41.10	D08B10	10	18	26	32	0.22
11	45.08	D08B11	11	21	30	35	0.22
12	49.07	D08B12	12	23	34	35	0.26
13	53.07	D08B13	12	25	38	35	0.28
14	57.07	D08B14	12	28	42	35	0.34
15	61.08	D08B15	12	30	46	35	0.36
16	65.10	D08B16	14	33	50	35	0.35
17	69.12	D08B17	14	36	54	35	0.44
18	73.14	D08B18	14	38	58	35	0.49
19	77.16	D08B19	14	40	62	35	0.57
20	81.18	D08B20	14	40	66	35	0.65
21	85.21	D08B21	16	45	70	40	0.72
22	89.24	D08B22	16	45	70	40	0.73
23	93.27	D08B23	16	45	70	40	0.83
24	97.30	D08B24	16	50	75	40	0.94
25	101.33	D08B25	16	52	80	40	0.98
26	105.36	D08B26	20	56	85	40	1.04
27	109.40	D08B27	20	56	85	40	1.08
28	113.43	D08B28	20	60	90	40	1.10
29	117.46	D08B29	20	62	95	40	1.14
30	121.50	D08B30	20	64	100	40	1.16
32	129.57	D08B32	20	64	100	40	1.24
35	141.68	D08B35	20	64	100	40	1.35
36	145.72	D08B36	20	73	110	40	2.05
38	153.79	D08B38	20	73	110	45	2.17
40	161.87	D08B40	20	73	110	45	2.28
42	169.94	D08B42	20	73	110	45	2.32
45	182.06	D08B45	20	73	110	45	2.49
48	194.18	D08B48	20	73	110	45	2.65
54	218.42	D08B54	25	73	110	45	2.98
57	230.54	D08B57	25	73	110	45	3.88
60	242.66	D08B60	25	73	110	45	4.08
68	283.07	D08B68	25	73	110	45	4.63
72	291.16	D08B72	25	73	110	45	4.90
76	307.32	D08B76	30	80	120	45	6.60
84	339.65	D08B84	30	80	120	45	7.29
95	384.11	D08B95	30	80	120	45	9.89
96	388.15	D08B96	30	80	120	45	9.99
114	460.90	D08B114	30	80	120	45	12.88

Maximum bores shown will accommodate standard keyseat and setscrew over keyseat. Slightly larger bores are possible with no keyseat, shallow keyseat, or setscrew at angle to keyseat.

Metric Sprockets



ISO **08B-2**
METRIC **40-2**

0.500 INCH (12.70mm) PITCH DUPLEX

SPROCKETS

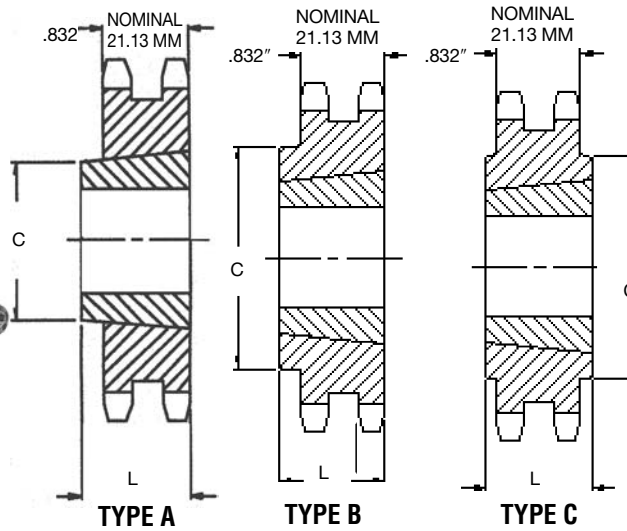
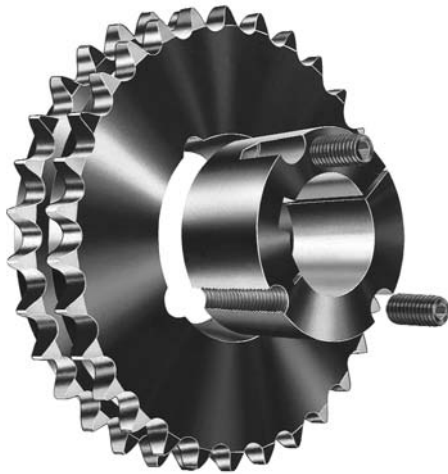

CHAIN DATA:
BS 228/7
ISO 08B-2
PITCH: 12.70mm (0.500 in.)
ROLLER DIAMETER: 8.51mm (0.335 in.)
ROLLER WIDTH: 7.75mm (0.305 in.)
TENSILE: 3180 kilos (7000 lbs.)

Duplex-Taper Bushed — Steel

No. Teeth	Pitch Diameter	Catalog Number	Bushing Number	Bore Max.	Dimension		Weight	
	MM				L	C	Rim	Bushing
				MM	MM	MM	Kilos	Kilos
15	61.08	D08ATB15	1008	25.40	22.22		0.18	0.13
16	65.10	D08ATB16	1008	25.40	22.22		0.22	0.13
17	69.12	D08ATB17	1008	25.40	22.22		0.27	0.13
18	73.14	D08BTB18	1210	31.75	25.40	58	0.27	0.27
19	77.16	D08BTB19	1210	31.75	25.40	63	0.36	0.27
21	85.21	D08BTB21	1610	41.27	25.40	70	0.46	0.41
22	89.24	D08BTB22	1610	41.27	25.40	74	0.55	0.41
23	93.27	D08BTB23	1610	41.27	25.40	78	0.59	0.41
24	97.30	D08BTB24	2012	41.27	25.40	83	0.70	0.41
25	101.33	D08BTB25	2012	50.80	31.75	87	0.77	0.77
26	105.36	D08BTB26	2012	50.80	31.75	87	0.80	0.77
28	113.43	D08BTB28	2012	50.80	31.75	99	1.06	0.77
30	121.50	D08BTB30	2012	50.80	31.75	108	1.59	0.77
35	141.68	D08BTB35	2012	50.80	31.75	108	1.86	0.77
36	145.72	D08BTB36	2012	50.80	31.75	108	1.91	0.77
38	153.79	D08BTB38	2012	50.80	31.75	108	3.18	0.77
42	169.94	D08CTB42	2517	50.80	44.45	108	5.57	1.59
45	182.06	D08CTB45	2517	63.50	44.45	108	5.97	1.59
48	194.18	D08CTB48	2517	63.50	44.45	108	6.37	1.59
54	218.42	D08CTB54	2517	63.50	44.45	108	7.17	1.59
57	230.54	D08CTB57	2517	63.50	44.45	108	7.56	1.59
60	242.66	D08CTB60	2517	63.50	44.45	108	12.05	1.59
68	274.99	D08CTB68	2517	63.50	44.45	108	13.66	1.59
70	283.07	D08CTB70	2517	63.50	44.45	108	14.06	1.59
72	291.15	D08CTB72	2517	63.50	44.45	108	14.46	1.59
76	307.32	D08CTB76	2517	63.50	44.45	108	15.26	1.59
84	339.65	D08CTB84	2517	63.50	44.45	108	16.87	1.59
95	384.11	D08CTB95	2517	63.50	44.45	108	19.08	1.59
96	388.15	D08CTB96	2517	63.50	44.45	108	19.28	1.59
114	460.91	D08CTB114	2517	63.50	44.45	108	22.90	1.59

ISO **08B-3**
METRIC **40-3**

0.500 INCH (12.70mm) PITCH TRIPLEX

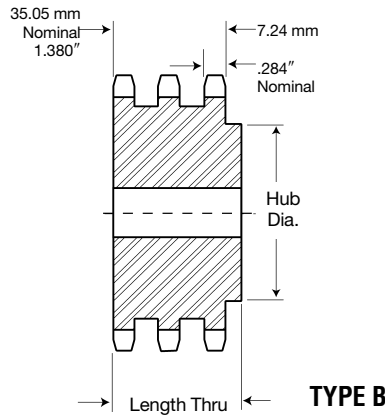

CHAIN DATA:

BS 228/7
ISO 08B-3
PITCH: 12.70mm (0.500 in.)
ROLLER DIAMETER: 8.51mm (0.335 in.)
ROLLER WIDTH: 7.75mm (0.305 in.)
TENSILE: 4540 kilos (10,000 lbs.)

Triples-Type B — Steel

No. Teeth	Pitch Diameter MM	Catalog Number	Bore		Hub		Weight (Approx.) Kilos
			Stock	Max.	Dia.	Thru	
			MM	MM	MM	MM	
11	45.08	E08B11	14	22	30	50	0.32
12	49.07	E08B12	14	24	34	50	0.45
13	53.06	E08B13	14	25	38	50	0.59
14	57.07	E08B14	14	28	42	50	0.72
15	61.08	E08B15	14	31	46	50	0.81
16	65.10	E08B16	16	35	50	50	0.90
17	69.12	E08B17	16	36	54	50	1.04
18	73.14	E08B18	16	38	58	50	1.22
19	77.16	E08B19	16	40	62	50	1.41
20	81.18	E08B20	16	40	66	50	1.58
21	85.21	E08B21	20	45	70	55	1.81
22	89.24	E08B22	20	45	70	55	2.03
23	93.27	E08B23	20	45	70	55	2.27
24	97.30	E08B24	20	50	75	55	2.44
25	101.33	E08B25	20	52	80	55	2.54
26	105.36	E08B26	20	56	85	55	2.85
27	109.40	E08B27	20	56	85	55	2.85
28	113.43	E08B28	20	60	90	55	3.16
29	117.46	E08B29	20	62	95	55	3.34
30	121.50	E08B30	20	64	100	55	3.48
35	141.68	E08B35	20	73	110	55	4.79
36	145.72	E08B36	25	80	120	55	5.43
38	153.79	E08B38	25	80	120	60	6.49
42	169.94	E08B42	25	80	120	60	7.17
45	182.06	E08B45	25	80	120	60	7.69
48	194.18	E08B48	25	80	120	60	8.20
52	210.34	E08B52	25	80	120	60	8.88
54	218.43	E08B54	25	80	120	60	9.22
57	230.54	E08B57	25	80	120	60	12.62
60	242.66	E08B60	25	85	130	65	13.84
68	274.99	E08B68	25	85	130	65	15.69
72	291.15	E08B72	25	85	130	65	16.61
76	307.32	E08B76	30	85	130	65	22.23
84	339.65	E08B84	30	85	130	65	24.57
95	384.11	E08B95	30	85	130	65	33.11
114	460.91	E08B114	30	85	130	65	41.90

Maximum bores shown will accommodate standard keyseat and setscrew over keyseat. Slightly larger bores are possible with no keyseat, shallow keyseat, or setscrew at angle to keyseat.

Metric Sprockets

Martin

0.625 INCH (15.88mm) PITCH **SIMPLEX**

ISO **10B-1**
METRIC **50**

Simplex-Type B — Steel

Simplex-Type A — Steel

No. Teeth	Pitch Diameter MM	Catalog Number	Bore		Hub		Weight (Approx.) Kilos	Catalog Number	Bore Stock MM	Weight (Approx.) Kilos
			Stock MM	Max. MM	Dia. MM	Thru MM				
8	41.48	10B8	12	16	22	25	0.09			
9	46.42	10B9	12	19	27	25	0.14			
10	51.37	10B10	12	22	32	25	0.23			
11	56.35	10B11	12	25	37	25	0.27			
12	61.34	10B12	12	32	43	25	0.32	10A12	12	0.15
13	66.33	10B13	12	33	48	25	0.36	10A13	12	0.19
14	71.34	10B14	12	36	53	25	0.45	10A14	12	0.23
15	76.36	10B15	12	38	57	25	0.59	10A15	12	0.25
16	81.37	10B16	12	44	63	25	0.68	10A16	12	0.31
17	86.39	10B17	12	47	67	25	0.82	10A17	12	0.35
18	91.42	10B18	12	48	73	25	0.91	10A18	12	0.39
19	96.45	10B19	16	51	76	25	1.04	10A19	16	0.43
20	101.48	10B20	16	51	76	25	1.13	10A20	16	0.48
21	106.51	10B21	16	51	76	25	1.18	10A21	16	0.51
22	111.55	10B22	16	51	76	25	1.27	10A22	16	0.59
23	116.59	10B23	16	51	76	25	1.45	10A23	16	0.65
24	121.62	10B24	16	51	76	32	1.50	10A24	15	0.68
25	126.66	10B25	16	51	76	32	1.59	10A25	15	0.73
26	131.70	10B26	16	51	76	32	1.63	10A26	15	0.78
27	136.74	10B27	19	51	76	32	1.68	10A27	18	0.89
28	141.79	10B28	19	51	76	32	1.72	10A28	18	0.93
29	146.83	10B29	19	51	76	32	1.91	10A29	18	1.07
30	151.87	10B30	19	57	82	32	2.04	10A30	18	1.15
31	156.92	10B31	19	57	82	32	2.13	10A31	18	1.27
32	161.96	10B32	19	57	82	32	2.27	10A32	18	1.23
33	167.01	10B33	19	57	82	32	2.33	10A33	18	1.42
34	172.05	10B34	19	57	82	32	2.36	10A34	18	1.45
35	177.10	10B35	19	57	82	32	2.48	10A35	18	1.51
36	182.15	10B36	19	57	82	32	2.56	10A36	18	1.73
37	187.19	10B37	19	57	82	32	2.68	10A37	18	1.81
38	192.24	10B38	19	57	82	32	2.72	10A38	18	1.88
39	197.29	10B39	19	57	82	32	2.86	10A39	18	2.00
40	202.33	10B40	19	57	82	32	2.95	10A40	18	2.02
41	207.38	10B41	19	57	82	32	3.01	10A41	18	2.20
42	212.43	10B42	19	57	82	32	3.16	10A42	18	2.26
43	217.48	10B43	19	57	82	32	3.20	10A43	18	2.38
44	222.53	10B44	19	57	82	32	3.44	10A44	18	2.46
45	227.58	10B45	19	64	95	32	3.73	10A45	18	2.69
46	232.63	10B46	19	64	95	32	3.85	10A46	18	2.91
47	237.68	10B47	19	64	95	32	3.89	10A47	18	2.95
48	242.73	10B48	25	64	95	32	4.18	10A48	24	2.98
49	247.78	10B49	25	64	95	32	4.21	10A49	24	3.20
50	252.82	10B50	25	64	95	32	4.40	10A50	24	3.22
51	257.87	10B51	25	64	95	32	4.48	10A51	24	3.32
52	262.92	10B52	25	64	95	32	4.64	10A52	24	3.62
53	267.97	10B53	25	64	95	32	4.75	10A53	24	3.67
54	273.03	10B54	25	64	95	32	4.86	10A54	24	3.76
55	278.08	10B55	25	64	95	32	4.96	10A55	24	3.88
56	283.13	10B56	25	64	95	32	5.22	10A56	24	4.04
57	288.18	10B57	25	64	95	32	5.27	10A57	24	4.25
58	293.23	10B58	25	64	95	32	5.36	10A58	24	4.67
59	298.28	10B59	25	64	95	32	5.59	10A59	24	4.76
60	303.33	10B60	25	64	95	32	5.90	10A60	24	4.90
70	353.84	10B70	25	64	95	44	8.24	10A70	24	6.35
72	363.94	10B72	25	64	95	44	8.84	10A72	24	6.91
76	384.15	10B76	25	64	95	44	11.03	10A76	24	9.11
80	404.36	10B80	25	70	108	44	11.22	10A80	24	9.53
84	424.57	10B84	25	70	108	44	11.57	10A84	24	10.02
95	480.14	10B95	25	70	108	44	14.57	10A95	24	12.25
96	485.19	10B96	25	70	108	44	14.93	10A96	24	12.43
112	566.03	10B112	25	70	108	44	19.05	10A112	24	17.10
114	576.13	10B114	25	70	108	44	20.61	10A114	24	17.84

CHAIN DATA:

BS 228/11
ISO 10B-1
PITCH: 15.88mm (0.625 in.)
ROLLER DIAMETER: 10.16mm (0.400 in.)
ROLLER WIDTH: 9.65mm (0.380 in.)
TENSILE: 2270 kilos (4500 lbs.)

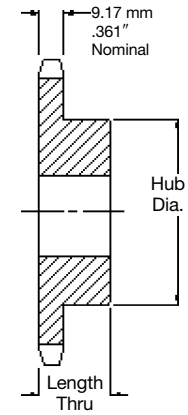
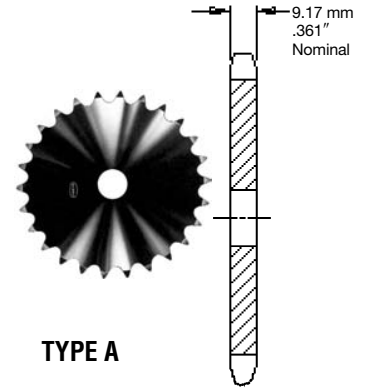

TYPE B

Maximum bores shown will accommodate standard keyseat and setscrew over keyseat. Slightly larger bores are possible with no keyseat, shallow keyseat, or setscrew at angle to keyseat.

SPROCKETS

ISO **10B-1**
METRIC **50**

0.625 INCH (15.88mm) PITCH SIMPLEX

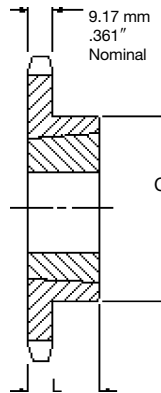

TYPE B

CHAIN DATA:

BS 228/11
ISO 10B-1
PITCH: 15.88mm (0.625 in.)
ROLLER DIAMETER: 10.16mm (0.400 in.)
ROLLER WIDTH: 9.65mm (0.380 in.)
TENSILE: 2270 kilos (5000 lbs.)

Simplex-Taper Bushed — Steel

No. Teeth	Pitch Diameter	Catalog Number	Bushing Number	Bore Max.	Dimension		Weight	
	MM			MM	L	C	Rim Kilos	Bushing Kilos
12	61.34	10BTB12H	1008	25.40	22.23	49.20*	0.23	0.14
13	66.33	10BTB13H	1008	25.40	22.23	46.02	0.23	0.14
14	71.34	10BTB14H	1008	25.40	22.23	49.20	0.27	0.14
15	76.35	10BTB15H	1210	31.75	25.40	62.69*	0.32	0.27
16	81.37	10BTB16H	1610	41.28	25.40	70.64*	0.41	0.41
17	86.39	10BTB17H	1610	41.28	25.40	70.64*	0.41	0.41
18	91.42	10BTB18H	1610	41.28	25.40	70.64	0.41	0.41
19	96.45	10BTB19H	1610	41.28	25.40	76.20	0.64	0.41
20	101.48	10BTB20H	1610	41.28	25.40	76.20	0.68	0.41
21	106.51	10BTB21H	1610	41.28	25.40	76.20	0.73	0.41
22	111.55	10BTB22H	1610	41.28	25.40	76.20	0.78	0.41
23	116.59	10BTB23H	2012	50.80	31.75	90.47	0.82	0.77
24	121.62	10BTB24H	2012	50.80	31.75	90.47	0.91	0.77
25	126.66	10BTB25H	2012	50.80	31.75	90.47	1.09	0.77
26	131.70	10BTB26H	2012	50.80	31.75	90.47	1.14	0.77
27	136.74	10BTB27H	2012	50.80	31.75	90.47	1.18	0.77
28	141.79	10BTB28H	2012	50.80	31.75	90.47	1.29	0.77
30	151.87	10BTB30H	2012	50.80	31.75	90.47	1.41	0.77
32	161.96	10BTB32	2012	50.80	31.75	90.47	1.63	0.77
35	177.10	10BTB35	2012	50.80	31.75	90.47	1.91	0.77
36	182.15	10BTB36	2012	50.80	31.75	90.47	1.95	0.77
38	192.24	10BTB38	2012	50.80	31.75	90.47	2.22	0.77
40	202.33	10BTB40	2012	50.80	31.75	90.47	2.36	0.77
42	212.43	10BTB42	2012	50.80	31.75	90.47	2.68	0.77
45	227.58	10BTB45	2012	50.80	31.75	90.47	2.95	0.77
48	242.73	10BTB48	2012	50.80	31.75	90.47	3.31	0.77
54	273.03	10BTB54	2012	50.80	31.75	90.47	4.08	0.77
57	288.18	10BTB57	2012	50.80	31.75	90.47	4.59	0.77
60	303.33	10BTB60	2012	50.80	31.75	90.47	4.90	0.77
70	353.84	10BTB70	2517	63.50	44.45	107.95	6.35	1.59
72	363.94	10BTB72	2517	63.50	44.45	107.95	7.03	1.59
76	384.15	10BTB76	2517	63.50	44.45	107.95	8.31	1.59
80	404.36	10BTB80	2517	63.50	44.45	107.95	8.85	1.59
84	424.57	10BTB84	2517	63.50	44.45	107.95	10.21	1.59
95	480.14	10BTB95	2517	63.50	44.45	107.95	12.76	1.59
96	485.19	10BTB96	2517	63.50	44.45	107.95	13.15	1.59
114	576.13	10BTB114	2517	63.50	44.45	107.95	19.61	1.59

* Has recessed groove in hub for chain clearance.
Sprockets with "H" suffix have hardened teeth.

Metric Sprockets

0.625 INCH (15.88mm) PITCH **DUPLEX**

ISO **10B-2**
METRIC **50-2**

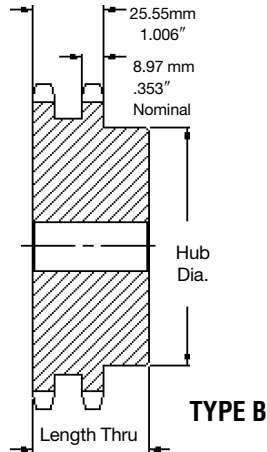

CHAIN DATA:

BS 228/11
ISO 10B-2
PITCH: 15.88mm (0.625 in.)
ROLLER DIAMETER: 10.16mm (0.400 in.)
ROLLER WIDTH: 9.65mm (0.380 in.)
TENSILE: 4540 kilos (10,000 lbs.)

SPROCKETS

Duplex-Type B — Steel

No. Teeth	Pitch Diameter MM	Catalog Number	Bore		Hub		Weight (Approx.) Kilos
			Stock	Max.	Dia.	Thru	
			MM	MM	MM	MM	
11	56.35	D10B11	14	24	37	40	0.44
12	61.34	D10B12	14	28	43	40	0.57
13	66.33	D10B13	14	33	48	40	0.71
14	71.34	D10B14	14	35	53	40	0.84
15	76.35	D10B15	14	38	58	40	1.01
16	81.37	D10B16	16	40	63	45	1.19
17	86.39	D10B17	16	45	68	45	1.38
18	91.42	D10B18	16	48	73	45	1.62
19	96.45	D10B19	16	52	79	45	1.77
20	101.48	D10B20	16	56	84	45	1.93
21	106.51	D10B21	16	56	85	45	2.22
22	111.55	D10B22	16	60	90	45	2.53
23	116.59	D10B23	16	62	95	45	2.77
24	121.62	D10B24	16	64	100	45	2.95
25	126.66	D10B25	16	68	105	45	3.15
26	131.70	D10B26	20	73	110	45	3.42
27	136.74	D10B27	20	73	110	45	3.98
28	141.79	D10B28	20	76	115	45	4.20
29	146.83	D10B29	20	76	115	45	4.43
30	151.87	D10B30	20	80	120	45	4.66
32	161.96	D10B32	20	80	120	45	5.16
35	177.10	D10B35	20	80	120	45	5.96
36	182.15	D10B36	20	80	120	45	6.70
38	192.24	D10B38	20	80	120	50	7.67
40	202.33	D10B40	30	80	120	50	7.92
45	227.58	D10B45	30	80	120	50	9.21
48	242.73	D10B48	30	80	120	60	10.92
57	288.18	D10B57	32	85	130	60	15.07
60	303.33	D10B60	32	85	130	60	16.27
70	353.84	D10B70	32	85	130	60	21.99
76	384.15	D10B76	32	85	130	60	26.31
80	404.36	D10B80	32	85	130	60	27.98
95	480.14	D10B95	32	85	130	60	32.69
114	576.13	D10B114	32	85	130	60	49.30

Maximum bores shown will accommodate standard keyseat and setscrew over keyseat. Slightly larger bores are possible with no keyseat, shallow keyseat, or setscrew at angle to keyseat.

0.625 INCH (15.88mm) PITCH DUPLEX

ISO 10B-2
METRIC 50-2

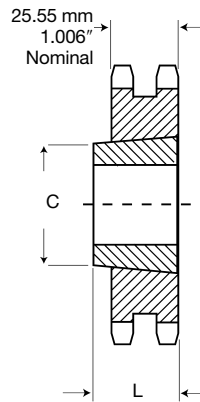
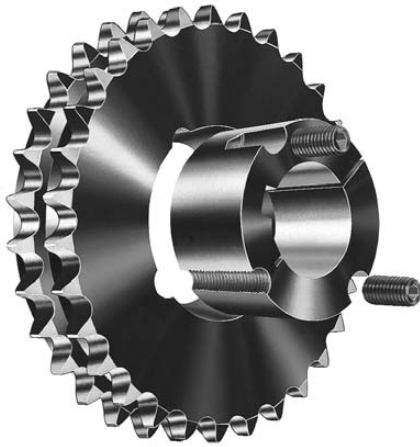

TYPE A

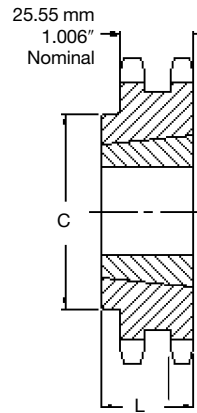

TYPE B

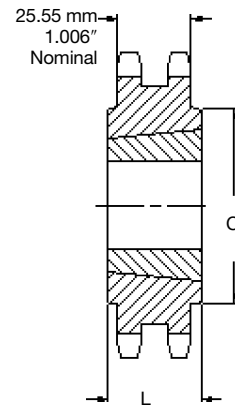

TYPE C

CHAIN DATA:

BS 228/11
ISO 10B-2
PITCH: 15.878mm (0.625 in.)
ROLLER DIAMETER: 10.16mm (0.400 in.)
ROLLER WIDTH: 9.65mm (0.380 in.)
TENSILE: 4540 kilos (10,000 lbs.)

Duplex-Taper Bushed — Steel

No. Teeth	Pitch Diameter MM	Catalog Number	Bushing Number	Bore Max. MM	Dimension		Weight	
					L MM	C MM	Rim Kilos	Bushing Kilos
14	71.34	D10ATB14	1008	25.40	22.23		0.45	0.14
15	76.35	D10ATB15	1210	31.75	25.40		0.48	0.27
16	81.37	D10ATB16	1210	31.75	25.40		0.50	0.27
17	86.39	D10ATB17	1610	41.28	25.40		0.57	0.41
18	91.42	D10ATB18	1610	41.28	25.40		0.64	0.41
19	96.45	D10ATB19	1610	41.28	25.40		0.71	0.41
20	101.49	D10BTB20	2012	50.80	25.40	84	0.82	0.77
21	106.52	D10BTB21	2012	50.80	25.40	89	0.86	0.77
22	111.55	D10BTB22	2012	50.80	31.75	99	1.45	0.77
23	116.59	D10BTB23	2012	50.80	31.75	109	1.72	0.77
25	126.66	D10BTB25	2012	50.80	31.75	134	3.40	0.77
30	151.87	D10BTB30	2517	63.50	44.45	107.95	3.92	1.59
36	182.15	D10CTB36	2517	63.50	44.45	107.95	4.54	1.59
38	192.24	D10CTB38	2517	63.50	44.45	107.95	5.68	1.59
42	212.43	D10CTB42	2517	63.50	44.45	107.95	7.95	1.59
48	242.73	D10CTB48	2517	63.50	44.45	107.95	11.35	1.59
57	288.18	D10CTB57	2517	63.50	44.45	107.95	19.69	1.59
60	303.33	D10CTB60	2517	63.50	44.45	107.95	22.47	1.59
68	343.74	D10CTB68	2517	63.50	44.45	107.95	25.47	1.59
76	384.15	D10CTB76	2517	63.50	44.45	107.95	37.30	1.59
84	424.57	D10CTB84	2517	63.50	44.45	107.95	44.72	1.59
95	480.14	D10CTB95	2517	63.50	44.45	107.95	52.14	1.59
114	576.13	D10CTB114	2517	63.50	44.45	107.95	62.57	1.59

Metric Sprockets

0.625 INCH (15.88mm) PITCH TRIPLEX

ISO **10B-3**
METRIC **50-3**

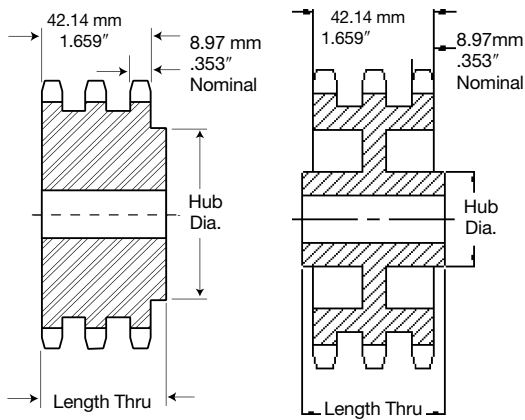

CHAIN DATA:

BS 228/11
ISO 10B-3
PITCH: 15.88mm (0.625 in.)
ROLLER DIAMETER: 10.16mm (0.400 in.)
ROLLER WIDTH: 9.65mm (0.380 in.)
TENSILE: 6810 kilos (10,000 lbs.)

TYPE B

TYPE C

Triplex-Type B — Steel

No. Teeth	Pitch Diameter MM	Catalog Number	Bore		Hub		Weight (Approx.) Kilos
			Stock MM	Max. MM	Dia. MM	Thru MM	
11	56.35	E10B11	16	24	37	55	0.68
12	61.34	E10B12	16	29	43	55	0.82
13	66.33	E10B13	16	34	48	55	1.05
14	71.34	E10B14	16	35	53	55	1.23
15	76.35	E10B15	16	38	58	55	1.36
16	81.37	E10B16	16	42	63	60	1.55
17	86.39	E10B17	16	45	68	60	1.81
18	91.42	E10B18	16	48	73	60	2.09
19	96.45	E10B19	16	52	79	60	2.40
20	101.48	E10B20	16	56	84	60	2.72
21	106.51	E10B21	20	56	85	60	3.04
22	111.55	E10B22	20	60	90	60	3.36
23	116.59	E10B23	20	62	95	60	3.67
24	121.62	E10B24	20	64	100	60	4.00
25	126.66	E10B25	20	68	105	60	4.31
26	131.70	E10B26	20	73	110	60	5.18
27	136.74	E10B27	20	73	110	60	5.63
28	141.79	E10B28	20	76	115	60	6.04
29	146.83	E10B29	20	76	115	60	6.22
30	151.87	E10B30	20	80	120	60	6.36
32	161.96	E10B32	20	80	120	60	7.26
35	177.10	E10B35	20	80	120	60	8.60
36	182.15	E10B36	25	80	120	60	9.34
38	192.24	E10B38	25	80	120	60	11.03
45	227.58	E10B45	30	80	120	75	14.94
48	242.73	E10B48	30	80	120	75	16.62
57	288.18	E10B57	32	80	120	75	21.77
60	303.33	E10B60	32	80	120	75	22.22
76	384.15	E10C76	32	80	120	89	23.13
80	404.36	E10C80	32	80	120	89	25.14
95	480.14	E10C95	32	80	120	95	32.66
114	576.13	E10C114	32	80	120	95	44.76

Maximum bores shown will accommodate standard keyseat and setscrew over keyseat. Slightly larger bores are possible with no keyseat, shallow keyseat, or setscrew at angle to keyseat.

ISO **12B-1**
METRIC **60**

0.750 INCH (19.05mm) PITCH **SIMPLEX**

CHAIN DATA:

BS 228/13
ISO 12B-1
PITCH: 19.05mm (0.750 in.)
ROLLER DIAMETER: 12.07mm (0.475 in.)
ROLLER WIDTH: 11.68mm (0.460 in.)
TENSILE: 2950 kilos (6500 lbs.)

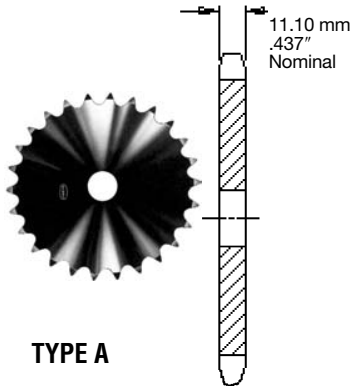

TYPE A

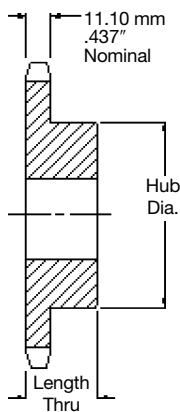

TYPE B

Simplex-Type B — Steel

Simplex-Type A — Steel

No. Teeth	Pitch Diameter MM	Catalog Number	Bore		Hub		Weight (Approx.) Kilos	Catalog Number	Bore Stock MM	Weight (Approx.) Kilos
			Stock MM	Max. MM	Dia. MM	Thru MM				
11	67.62	12B11	12	32	47	35	.53	12A11	14	.36
12	73.60	12B12	12	35	53	35	.67	12A12	14	.42
13	79.60	12B13	12	38	59	35	.75	12A13	14	.48
14	85.61	12B14	12	42	64	35	.91	12A14	14	.54
15	91.63	12B15	12	45	70	35	1.14	12A15	14	.60
16	97.65	12B16	16	50	75	35	1.27	12A16	14	.68
17	103.67	12B17	16	52	80	35	1.46	12A17	14	.77
18	109.71	12B18	16	52	80	35	1.69	12A18	14	.85
19	115.74	12B19	16	60	90	35	1.78	12A19	14	.95
20	121.78	12B20	16	64	90	35	2.10	12A20	14	1.08
21	127.82	12B21	20	64	100	40	2.27	12A21	16	1.15
22	133.86	12B22	20	64	100	40	2.38	12A22	16	1.24
23	139.90	12B23	20	67	100	40	2.49	12A23	16	1.33
24	145.95	12B24	20	67	100	40	2.62	12A24	19	1.47
25	151.99	12B25	20	67	100	40	2.78	12A25	19	1.63
26	158.04	12B26	20	67	100	40	2.89	12A26	19	1.72
27	164.09	12B27	20	67	100	40	3.05	12A27	19	1.91
28	170.14	12B28	20	67	100	40	3.12	12A28	19	1.99
29	176.19	12B29	20	67	100	40	3.30	12A29	19	2.44
30	182.25	12B30	20	67	100	40	3.44	12A30	19	2.28
31	188.30	12B31	20	67	100	40	3.50	12A31	19	2.49
32	194.35	12B32	20	67	100	40	3.75	12A32	19	2.62
33	200.41	12B33	20	67	100	40	3.82	12A33	19	2.77
34	206.46	12B34	20	67	100	40	3.99	12A34	19	2.91
35	212.52	12B35	20	67	100	40	4.10	12A35	19	3.19
36	218.57	12B36	20	67	100	40	4.35	12A36	19	3.21
37	224.63	12B37	20	67	100	40	4.64	12A37	19	3.52
38	230.69	12B38	25	70	107	40	4.92	12A38	24	3.67
39	236.74	12B39	25	70	107	40	5.15	12A39	24	3.87
40	242.80	12B40	25	70	107	40	5.22	12A40	24	4.00
41	248.86	12B41	25	70	107	40	5.51	12A41	24	4.24
42	254.92	12B42	25	70	107	40	5.78	12A42	24	4.53
43	260.98	12B43	25	70	107	40	5.90	12A43	24	4.58
44	267.03	12B44	25	70	107	40	6.30	12A44	25	4.99
45	273.09	12B45	25	70	107	40	6.34	12A45	25	5.14
46	279.15	12B46	25	70	107	40	6.62	12A46	25	5.33
47	285.21	12B47	25	70	107	40	6.80	12A47	25	5.70
48	291.27	12B48	25	70	107	40	7.18	12A48	25	5.75
50	303.39	12B50	25	70	107	40	8.01	12A50	25	6.45
54	327.63	12B54	32	70	110	45	9.80	12A54	32	7.33
57	345.81	12B57	32	70	110	45	10.10	12A57	32	8.11
60	363.99	12B60	32	70	110	45	11.44	12A60	32	9.19
65	394.30	12B65	32	70	110	45	13.12	12A65	32	10.65
70	424.61	12B70	32	70	110	45	14.51	12A70	32	12.45
72	436.73	12B72	32	80	120	50	15.50	12A72	32	13.22
76	460.98	12B76	32	80	120	50	17.26	12A76	32	14.78
80	485.23	12B80	32	80	120	50	19.00	12A80	32	20.75
84	509.48	12B84	32	80	120	50	21.07	12A84	32	21.78
95	576.17	12B95	32	92	140	55	23.83	12A95	32	23.46
96	582.23	12B96	32	92	140	55	26.61	12A96	32	23.71
114	691.36	12B114	32	92	140	55	33.98	12A114	32	28.16

Maximum bores shown will accommodate standard keyseat and setscrew over keyseat. Slightly larger bores are possible with no keyseat, shallow keyseat, or setscrew at angle to keyseat.

Metric Sprockets

0.750 INCH (19.05mm) PITCH **SIMPLEX**

ISO **12B-1**
METRIC **60**

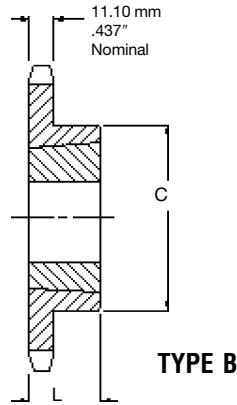

CHAIN DATA:

BS 228/13
ISO 12B-1
PITCH: 19.05mm (0.750 in.)
ROLLER DIAMETER: 12.07mm (0.475 in.)
ROLLER WIDTH: 11.68mm (0.460 in.)
TENSILE: 2950 kilos (6500 lbs.)

SPROCKETS

Simplex-Taper Bushed — Steel

No. Teeth	Pitch Diameter	Catalog Number	Bushing Number	Bore Max.	Dimension		Weight	
	MM				L	C	Rim	Bushing
				MM	MM	MM	Kilos	Kilos
11	67.62	12BTB11H	1008	25.40	22.23	46.04	0.27	0.14
12	73.61	12BTB12H	1008	25.40	22.23	49.21	0.36	0.14
13	79.60	12BTB13H	1210	31.75	25.40	62.69	0.41	0.27
14	85.61	12BTB14H	1210	31.75	25.40	62.69	0.45	0.27
15	91.63	12BTB15H	1610	41.28	25.40	70.64	0.54	0.41
16	97.65	12BTB16H	1610	41.28	25.40	76.20	0.73	0.41
17	103.67	12BTB17H	1610	41.28	25.40	82.55	0.82	0.41
18	109.70	12BTB18H	1610	41.28	25.40	82.55	0.91	0.41
19	115.74	12BTB19H	1610	41.28	25.40	82.55	1.00	0.41
20	121.78	12BTB20H	2012	50.80	31.75	90.47	1.00	0.77
21	127.82	12BTB21H	2012	50.80	31.75	90.47	1.18	0.77
22	133.86	12BTB22H	2012	50.80	31.75	90.47	1.27	0.77
23	139.90	12BTB23H	2012	50.80	31.75	90.47	1.27	0.77
24	145.95	12BTB24H	2012	50.80	31.75	90.47	1.50	0.77
25	151.99	12BTB25H	2012	50.80	31.75	90.47	1.74	0.77
26	158.04	12BTB26H	2012	50.80	31.75	90.47	1.74	0.77
27	164.09	12BTB27H	2012	50.80	31.75	90.47	1.80	0.77
28	170.14	12BTB28H	2012	50.80	31.75	90.47	2.04	0.77
30	182.25	12BTB30H	2012	50.80	31.75	90.47	2.32	0.77
32	194.35	12BTB32	2012	50.80	31.75	90.47	2.48	0.77
35	212.52	12BTB35	2012	50.80	31.75	90.47	2.71	0.77
36	218.57	12BTB36	2012	50.80	31.75	90.47	2.78	0.77
38	230.69	12BTB38	2012	50.80	31.75	90.47	3.36	0.77
40	242.80	12BTB40	2012	50.80	31.75	90.47	3.53	0.77
42	254.92	12BTB42	2012	50.80	31.75	90.47	3.71	0.77
45	273.09	12BTB45	2012	50.80	31.75	90.47	3.98	0.77
48	291.27	12BTB48	2012	50.80	31.75	90.47	4.24	0.77
54	327.63	12BTB54	2517	63.50	44.45	107.95	8.30	1.59
57	345.81	12BTB57	2517	63.50	44.45	107.95	8.76	1.59
60	363.99	12BTB60	2517	63.50	44.45	107.95	9.22	1.59
68	412.49	12BTB68	2517	63.50	44.45	107.95	10.45	1.59
70	424.61	12BTB70	2517	63.50	44.45	107.95	10.76	1.59
72	436.73	12BTB72	2517	63.50	44.45	107.95	11.06	1.59
76	460.98	12BTB76	2517	63.50	44.45	107.95	11.68	1.59
84	509.48	12BTB84	2517	63.50	44.45	107.95	12.91	1.59
95	576.17	12BTB95	2517	63.50	44.45	107.95	14.60	1.59
96	582.23	12BTB96	2517	63.50	44.45	107.95	14.75	1.59
114	691.36	12BTB114	2517	63.50	44.45	107.95	17.52	1.59

Sprockets with "H" suffix have hardened teeth.

0.750 INCH (19.05mm) PITCH DUPLEX

ISO **12B-2**
METRIC **60-2**

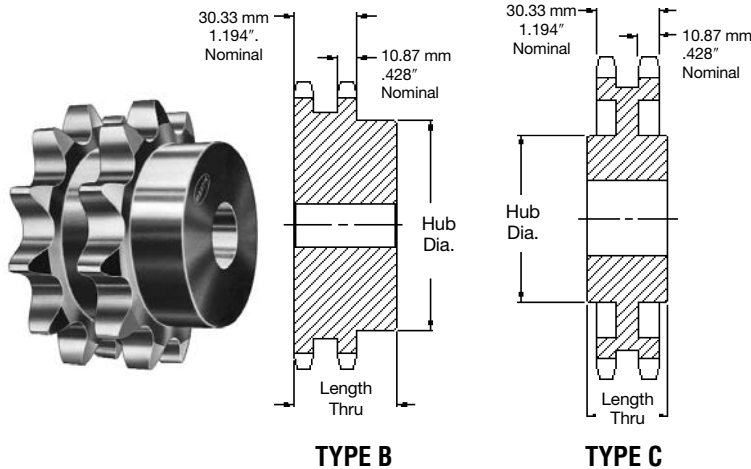

CHAIN DATA:

BS 228/13
ISO 12B-2
PITCH: 19.05mm (0.750 in.)
ROLLER DIAMETER: 12.07mm (0.475 in.)
ROLLER WIDTH: 11.68mm (0.460 in.)
TENSILE: 5900 kilos (13,000 lbs.)

Duplex-Type B/C — Steel

No. Teeth	Pitch Diameter MM	Catalog Number	Bore		Hub		Weight (Approx.) Kilos
			Stock MM	Max. MM	Dia. MM	Thru MM	
11	67.62	D12B11	16	32	47	50	1.00
12	73.60	D12B12	16	36	53	50	1.23
13	79.60	D12B13	16	38	59	50	1.41
14	85.61	D12B14	16	42	65	50	1.68
15	91.63	D12B15	16	45	71	50	1.95
16	97.65	D12B16	20	51	77	50	2.27
17	103.67	D12B17	20	54	83	50	2.63
18	109.70	D12B18	20	60	89	50	3.18
19	115.74	D12B19	20	62	95	50	3.50
20	121.78	D12B20	20	64	100	50	3.72
21	127.82	D12B21	20	64	100	50	4.31
22	133.86	D12B22	20	64	100	50	4.77
23	139.90	D12B23	20	73	110	50	4.99
24	145.95	D12B24	20	73	110	50	5.45
25	151.99	D12B25	20	80	120	50	5.67
26	158.04	D12B26	20	80	120	50	6.13
27	164.09	D12B27	20	80	120	50	6.49
28	170.14	D12B28	20	80	120	50	6.81
29	176.19	D12B29	20	80	120	50	7.13
30	182.25	D12B30	20	80	120	50	7.49
32	194.35	D12B32	20	85	130	50	9.31
35	212.52	D12B35	20	85	130	50	10.18
36	218.57	D12B36	25	85	130	50	12.31
38	230.69	D12B38	25	85	130	50	12.99
40	242.80	D12B40	25	85	130	50	13.67
45	273.09	D12B45	25	85	130	50	15.38
48	291.27	D12B48	25	85	130	50	16.41
57	345.81	D12B57	32	85	130	65	25.34
60	363.99	D12B60	32	85	130	65	26.67
68	412.49	D12C68	32	85	130	75	30.48
76	460.98	D12C76	40	85	130	75	25.63
80	485.23	D12C80	40	85	130	75	26.98
95	576.17	D12C95	40	93	140	85	39.24
96	582.23	D12C96	40	93	140	85	39.65
114	691.36	D12C114	40	93	140	85	41.86

Maximum bores shown will accommodate standard keyseat and setscrew over keyseat. Slightly larger bores are possible with no keyseat, shallow keyseat, or setscrew at angle to keyseat.

Metric Sprockets



ISO **12B-2**
METRIC **60-2**

0.750 INCH (19.05mm) PITCH **DUPLEX**

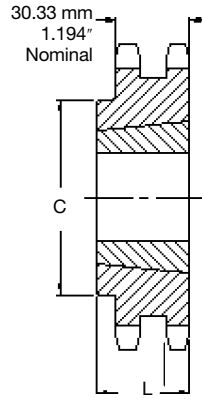
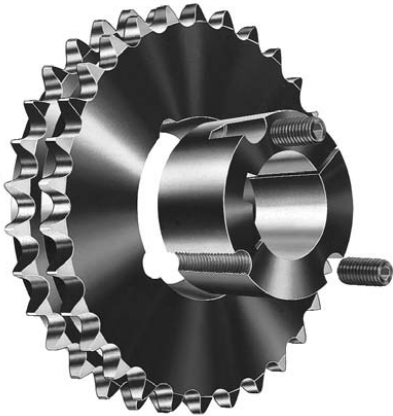

TYPE B

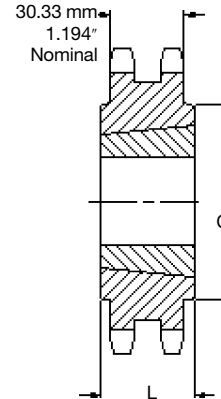

TYPE C

CHAIN DATA:

BS 228/13
ISO 12B-2
PITCH: 19.05mm (0.750 in.)
ROLLER DIAMETER: 12.07mm (0.475 in.)
ROLLER WIDTH: 11.68mm (0.460 in.)
TENSILE: 5900 kilos (13000 lbs.)

Duplex-Taper Bushed — Steel

No. Teeth	Pitch Diameter	Catalog Number	Bushing Number	Bore Max.	Dimension		Weight	
	MM				L	C	Rim	Bushing
				MM	MM	MM	Kilos	Kilos
12	73.60	D12BTB12	1215	31.75	38.10	53.54	.61	0.73
13	79.60	D12BTB13	1215	31.75	38.10	59.74	.66	0.77
14	85.61	D12BTB14	1215	31.75	38.10	65.91	.84	0.82
15	91.63	D12BTB15	1615	41.28	38.10	72.09	.70	0.77
16	97.65	D12BTB16	1615	41.28	38.10	76.20	1.11	0.77
17	103.67	D12BTB17	1615	41.28	38.10	82.93	1.25	0.77
18	109.70	D12BTB18	2012	50.80	31.75	90.50	1.56	0.77
19	115.74	D12BTB19	2012	50.80	31.75	96.6	1.81	0.77
20	121.78	D12BTB20	2517	63.50	44.45	102.00	2.04	1.59
21	127.82	D12BTB21	2517	63.50	44.45	107.95	2.50	1.59
22	133.86	D12BTB22	2517	63.50	44.45	107.95	2.78	1.59
23	139.90	D12BTB23	2517	63.50	44.45	107.95	3.07	1.59
24	145.95	D12BTB24	2517	63.50	44.45	107.95	3.35	1.59
25	151.99	D12BTB25	2517	63.50	44.45	107.95	3.63	1.59
26	158.04	D12BTB26	2517	63.50	44.45	107.95	3.91	1.59
27	164.09	D12BTB27	2517	63.50	44.45	107.95	4.20	1.59
28	170.14	D12BTB28	2517	63.50	44.45	107.95	4.48	1.59
30	182.25	D12BTB30	2517	63.50	44.45	107.95	5.04	1.59
32	194.35	D12BTB32	2517	63.50	44.45	107.95	5.61	1.59
35	212.52	D12BTB35	2517	63.50	44.45	107.95	6.46	1.59
38	230.69	D12BTB38	2517	63.50	44.45	107.95	8.40	1.59
40	242.80	D12CTB40	2517	63.50	44.45	107.95	9.56	1.59
42	254.92	D12CTB42	2517	63.50	44.45	107.95	10.73	1.59
45	273.09	D12CTB45	2517	63.50	44.45	107.95	12.48	1.59
48	291.27	D12CTB48	2517	63.50	44.45	107.95	14.23	1.59
54	327.63	D12CTB54	2517	63.50	44.45	107.95	17.73	1.59
57	345.81	D12CTB57	2517	63.50	44.45	107.95	19.48	1.59
60	363.99	D12CTB60	2517	63.50	44.45	107.95	21.23	1.59
65	394.30	D12CTB65	2517	63.50	44.45	107.95	24.15	1.59
70	424.61	D12CTB70	2517	63.50	44.45	107.95	27.06	1.59
75	454.92	D12CTB75	3020	76.20	50.80	133.35	19.27	2.95
76	460.98	D12CTB76	3020	76.20	50.80	133.35	19.52	2.95
84	509.48	D12CTB84	3020	76.20	50.80	133.35	21.58	2.95
95	576.17	D12CTB95	3020	76.20	50.80	133.35	24.40	2.95
96	582.23	D12CTB96	3020	76.20	50.80	133.35	24.66	2.95
114	691.36	D12CTB114	3020	76.20	50.80	133.35	29.28	2.95

ISO 12B-3
METRIC 60-3

0.750 INCH (19.05mm) PITCH TRIPLEX

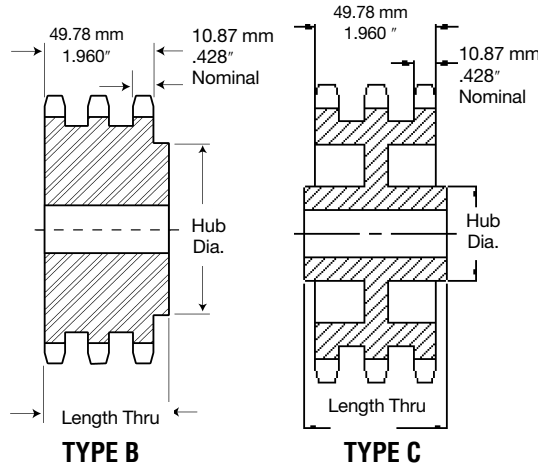

CHAIN DATA:

BS 228/13
ISO 12B-3
PITCH: 19.05mm (0.750 in.)
ROLLER DIAMETER: 12.07mm (0.475 in.)
ROLLER WIDTH: 11.68mm (0.460 in.)
TENSILE: 8850 Kilos (19,500 lbs.)

SPROCKETS

Triples-Type B/C — Steel

No. Teeth	Pitch Diameter MM	Catalog Number	Bore		Hub		Weight (Approx.) Kilos
			Stock MM	Max. MM	Dia. MM	Thru MM	
11	67.62	E12B11	20	32	47	70	1.13
12	73.60	E12B12	20	36	53	70	1.50
13	79.60	E12B13	20	38	59	70	1.77
14	85.61	E12B14	20	42	65	70	2.04
15	91.63	E12B15	20	45	71	70	2.45
16	97.65	E12B16	20	51	77	70	2.95
17	103.67	E12B17	20	54	83	70	3.49
18	109.70	E12B18	20	60	89	70	3.86
19	115.74	E12B19	20	62	95	70	4.54
20	121.78	E12B20	20	64	100	70	5.08
21	127.82	E12B21	20	64	100	70	5.67
22	133.86	E12B22	20	64	100	70	5.99
23	139.90	E12B23	20	73	110	70	6.62
24	145.95	E12B24	20	73	110	70	7.17
25	151.99	E12B25	20	80	120	70	7.71
26	158.04	E12B26	20	80	120	70	8.44
27	164.09	E12B27	20	80	120	70	8.99
28	170.14	E12B28	20	80	120	70	9.49
29	176.19	E12B29	20	80	120	70	9.99
30	182.25	E12B30	20	80	120	70	10.53
35	212.52	E12B35	25	85	130	70	18.95
36	218.57	E12B36	25	85	130	70	19.49
38	230.69	E12B38	25	85	130	70	20.57
45	273.10	E12B45	25	85	130	70	24.36
48	291.27	E12B48	25	85	130	70	25.98
57	345.81	E12B57	32	82	130	85	33.73
60	363.99	E12C60	32	82	130	85	35.51
68	412.49	E12C68	32	82	130	85	40.24
76	460.98	E12C76	40	95	140	85	37.19
80	485.23	E12C80	40	95	140	85	39.15
95	576.17	E12C95	40	95	140	100	47.63

Maximum bores shown will accommodate standard keyseat and setscrew over keyseat. Slightly larger bores are possible with no keyseat, shallow keyseat, or setscrew at angle to keyseat.

Metric Sprockets

Martin

1.00 INCH (25.40mm) PITCH SIMPLEX

ISO **16B-1**
METRIC **80**

CHAIN DATA:

BS 228/15

ISO 16B-1

PITCH: 25.40mm (1.00 in.)

ROLLER DIAMETER: 15.88mm (0.625 in.)

ROLLER WIDTH: 17.02mm (0.670 in.)

TENSILE: 4310 kilos (9,500 lbs.)

Simplex-Type B/C — Steel

Simplex-Type A — Steel

No. Teeth	Pitch Diameter MM	Catalog Number	Bore		Hub		Weight (Approx.) Kilos	Catalog Number	Bore Stock MM	Weight (Approx.) Kilos
			Stock MM	Max. MM	Dia. MM	Thru MM				
11	90.16	16B11	16	41	63	40	1.45	16A11	14	0.82
12	98.14	16B12	16	47	72	40	1.82	16A12	14	0.91
13	106.14	16B13	16	52	79	40	1.82	16A13	14	1.04
14	114.15	16B14	16	60	88	40	2.09	16A14	14	1.22
15	122.17	16B15	16	62	96	40	2.59	16A15	14	1.36
16	130.20	16B16	20	67	100	45	3.00	16A16	14	1.54
17	138.23	16B17	25	67	102	45	3.18	16A17	14	1.81
18	146.27	16B18	25	70	108	45	3.77	16A18	24	2.00
19	154.32	16B19	25	70	108	45	3.86	16A19	24	2.13
20	162.37	16B20	25	70	108	45	4.09	16A20	24	2.49
21	170.42	16B21	25	70	108	50	4.54	16A21	24	2.63
22	178.48	16B22	25	70	108	50	4.99	16A22	24	2.82
23	186.56	16B23	25	70	108	50	5.08	16A23	24	3.04
24	194.60	16B24	25	70	108	50	5.54	16A24	24	3.45
25	202.66	16B25	25	70	108	50	5.76	16A25	24	3.63
26	210.72	16B26	32	80	120	50	7.03	16A26	30	3.90
27	218.79	16B27	32	80	120	50	7.53	16A27	30	4.31
28	226.86	16B28	32	80	120	50	7.58	16A28	30	4.58
29	234.93	16B29	32	80	120	50	7.94	16A29	30	4.81
30	243.00	16B30	32	80	120	50	8.26	16A30	32	5.22
31	251.07	16B31	32	80	120	50	8.62	16A31	32	5.56
32	259.14	16B32	32	80	120	50	8.98	16A32	32	5.90
33	267.21	16B33	32	80	120	50	9.33	16A33	32	6.24
34	275.28	16B34	32	80	120	50	9.69	16A34	32	6.58
35	283.36	16B35	32	80	120	50	10.05	16A35	32	6.92
36	291.43	16B36	32	80	120	50	10.41	16A36	32	7.26
37	299.51	16B37	32	80	120	50	10.76	16A37	32	7.60
38	307.58	16B38	32	80	120	50	11.12	16A38	32	7.94
39	315.66	16B39	32	80	120	50	11.48	16A39	32	8.48
40	323.74	16B40	32	80	120	50	11.83	16A40	32	9.01
41	331.81	16B41	32	80	120	50	12.19	16A41	32	9.55
42	339.89	16B42	32	80	120	50	12.55	16A42	32	10.09
43	347.97	16B43	32	80	120	50	12.91	16A43	32	10.62
44	356.05	16B44	32	80	120	50	13.27	16A44	32	11.16
45	364.12	16B45	32	80	120	50	13.62	16A45	32	11.70
46	372.20	16B46	32	80	120	50	13.98	16A46	32	12.23
47	380.28	16B47	32	80	120	50	14.34	16A47	32	12.77
48	388.36	16B48	32	80	120	50	14.70	16A48	32	12.31
49	396.44	16B49	32	80	120	50	15.05	16A49	32	13.85
50	404.52	16B50	32	80	120	50	15.41	16A50	32	14.38
54	436.84	16B54	32	85	130	50	20.99	16A54	32	16.53
57	461.08	16B57	32	85	130	50	22.16	16A57	32	18.14
60	485.33	16B60	32	85	130	50	23.33	16A60	32	19.75
65	525.73	16B65	32	85	130	50	25.27	16A65	32	22.43
70	566.15	16C70	40	108	159	90	33.59	16A70	40	25.47
72	582.31	16C72	40	108	159	90	35.48	16A72	40	27.94
76	614.64	16C76	40	108	159	90	39.24	16A76	40	32.89
80	646.97	16C80	40	108	159	90	43.00	16A80	40	37.84
84	679.30	16C84	40	108	159	90	46.77	16A84	40	42.78
90	727.80	16C90	40	108	159	90	52.41	16A90	40	50.21
95	768.22	16C95	40	108	159	90	57.12	16A95	40	56.39
96	766.31	16C96	40	108	159	90	58.06	16A96	40	57.63
114	921.81	16C114	40	108	159	90	75.00	16A114	40	76.36

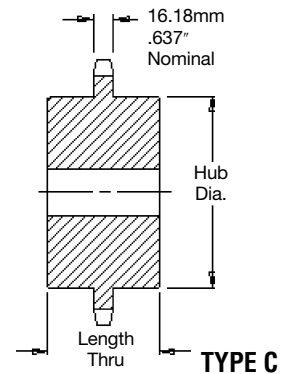
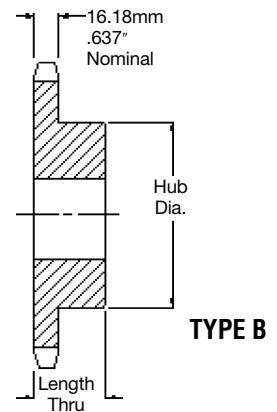
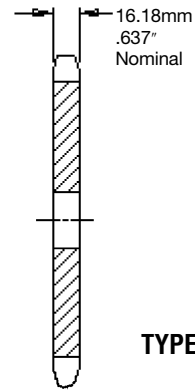

Maximum bores shown will accommodate standard keyseat and setscrew over keyseat. Slightly larger bores are possible with no keyseat, shallow keyseat, or setscrew at angle to keyseat.

ISO **16B-1**
METRIC **80**

1.00 INCH (25.40mm) PITCH SIMPLEX

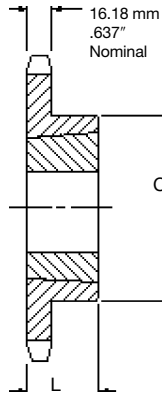
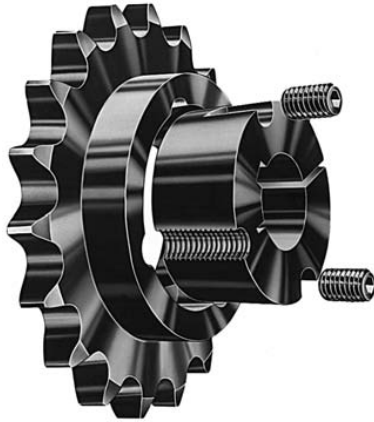

TYPE B

CHAIN DATA:

BS 228/15
ISO 16B-1
PITCH: 25.40mm (1.00 in.)
ROLLER DIAMETER: 15.88mm (0.625 in.)
ROLLER WIDTH: 17.02mm (0.670 in.)
TENSILE: 4310 KILOS (9,500 lbs.)

Simplex-Taper Bushed — Steel

No. Teeth	Pitch Diameter	Catalog Number	Bushing Number	Bore Max.	Dimension		Weight	
	MM			MM	L	C	Rim Kilos	Bushing Kilos
10	82.20	16BTB10H	1215	31.75	38.10	62.69	0.73	0.36
11	90.16	16BTB11H	1215	31.75	38.10	62.69	0.91	0.36
12	98.14	16BTB12H	1615	41.28	38.10	76.20	1.04	0.54
13	106.14	16BTB13H	1615	41.28	38.10	76.20	1.27	0.54
14	114.15	16BTB14H	1615	41.28	38.10	82.55	1.36	0.54
15	122.17	16BTB15H	1615	41.28	38.10	82.55	1.45	0.54
16	130.20	16BTB16H	2012	50.80	31.75	90.47	1.55	0.77
17	138.23	16BTB17H	2012	50.80	31.75	90.47	1.69	0.77
18	146.27	16BTB18H	2012	50.80	31.75	90.47	1.46	0.77
19	154.32	16BTB19H	2012	50.80	31.75	90.47	2.14	0.77
20	162.37	16BTB20H	2517	63.50	44.45	107.95	2.72	1.59
21	170.42	16BTB21H	2517	63.50	44.45	107.95	2.95	1.59
22	178.48	16BTB22H	2517	63.50	44.45	107.95	3.18	1.59
23	186.54	16BTB23H	2517	63.50	44.45	107.95	3.40	1.59
24	194.60	16BTB24H	2517	63.50	44.45	107.95	3.63	1.59
25	202.66	16BTB25H	2517	63.50	44.45	107.95	3.90	1.59
26	210.72	16BTB26H	2517	63.50	44.45	107.95	4.22	1.59
27	218.79	16BTB27H	2517	63.50	44.45	107.95	4.31	1.59
28	226.86	16BTB28H	2517	63.50	44.45	107.95	4.54	1.59
30	243.00	16BTB30H	2517	63.50	44.45	107.95	5.44	1.59
32	259.14	16BTB32	2517	63.50	44.45	107.95	5.67	1.59
35	283.36	16BTB35	2517	63.50	44.45	107.95	7.12	1.59
36	291.43	16BTB36	2517	63.50	44.45	107.95	7.94	1.59
38	307.58	16BTB38	2517	63.50	44.45	107.95	8.85	1.59
40	323.74	16BTB40	2517	63.50	44.45	107.95	9.75	1.59
45	364.12	16BTB45	2517	63.50	44.45	107.95	12.25	1.59
48	388.36	16BTB48	2517	63.50	44.45	107.95	13.61	1.59
54	436.84	16BTB54	2517	63.50	44.45	107.95	17.69	1.59
57	461.07	16BTB57	2517	63.50	44.45	107.95	19.16	1.59
60	485.33	16BTB60	2517	63.50	44.45	107.95	20.64	1.59
64	517.65	16BTB64	3020	76.20	50.80	133.35	19.35	2.95
70	566.15	16BTB70	3020	76.20	50.80	133.35	23.95	2.95
76	614.64	16BTB76	3020	76.20	50.80	133.35	28.55	2.95
80	646.97	16BTB80	3020	76.20	50.80	133.35	31.62	2.95
84	679.30	16BTB84	3020	76.20	50.80	133.35	34.68	2.95
95	768.22	16BTB95	3020	76.20	50.80	133.35	41.58	2.95
114	921.81	16BTB114	3020	76.20	50.80	133.35	56.15	2.95

Sprockets with "H" suffix have hardened teeth.

Metric Sprockets

ISO **16B-2**
METRIC **80-2**

1.00 INCH (25.40mm) PITCH DUPLEX

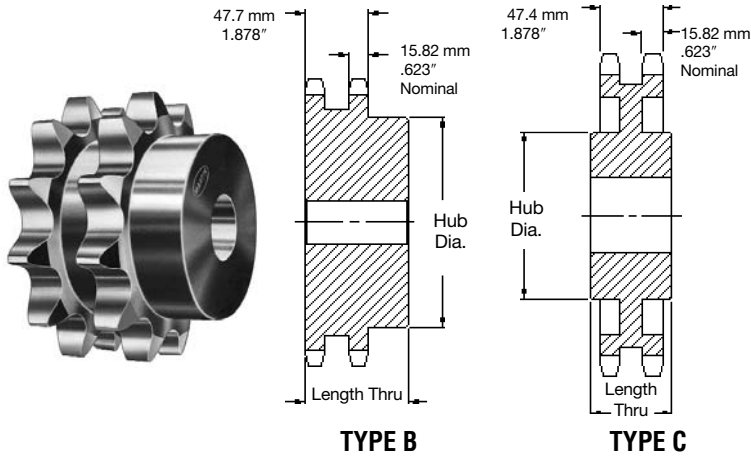

CHAIN DATA:

BS 228/15
ISO 16B-2
PITCH: 25.40mm (1.00 in.)
ROLLER DIAMETER: 15.88mm (0.625 in.)
ROLLER WIDTH: 17.02mm (0.670 in.)
TENSILE: 8620 kilos (19,000 lbs.)

SPROCKETS

Duplex-Type B/C — Steel

No. Teeth	Pitch Diameter MM	Catalog Number	Bore		Hub		Weight (Approx.) Kilos
			Stock	Max.	Dia.	Thru	
			MM	MM	MM	MM	
11	90.16	D16B11	20	42	63	70	1.82
12	98.14	D16B12	20	45	72	70	2.36
13	106.14	D16B13	20	52	80	70	2.95
14	114.15	D16B14	20	53	88	70	3.50
15	122.17	D16B15	20	62	96	70	4.18
16	130.20	D16B16	20	66	104	70	5.22
17	138.23	D16B17	20	74	112	70	5.99
18	146.27	D16B18	20	80	120	70	6.81
19	154.32	D16B19	20	84	128	70	7.71
20	162.37	D16B20	20	85	130	70	8.26
21	170.42	D16B21	25	85	130	70	8.85
22	178.28	D16B22	25	85	130	70	9.53
23	186.54	D16B23	25	85	130	70	10.43
24	194.60	D16B24	25	85	130	70	11.44
25	202.66	D16B25	25	85	130	70	12.47
26	210.72	D16B26	25	85	130	70	13.62
27	218.79	D16B27	25	85	130	70	14.75
28	226.86	D16B28	25	85	130	70	15.89
29	234.93	D16B29	25	85	130	70	17.02
30	243.00	D16B30	25	95	145	75	18.16
32	259.14	D16B32	32	95	145	75	19.86
35	283.36	D16B35	32	95	145	75	22.27
36	291.43	D16B36	32	95	145	80	28.04
38	307.58	D16B38	32	95	145	80	29.60
42	339.89	D16B42	40	95	145	80	32.20
45	364.12	D16C45	40	95	145	95	34.35
57	461.07	D16C57	40	95	145	95	38.18
60	485.33	D16C60	40	95	145	95	42.77
68	549.98	D16C68	40	96	153	102	43.86
76	614.64	D16C76	40	96	152	102	68.11
80	646.97	D16C80	40	102	152	108	54.88
95	768.22	D16C95	40	102	152	108	72.57
114	921.81	D16C114	40	102	152	108	78.22

Maximum bores shown will accommodate standard keyseat and setscrew over keyseat. Slightly larger bores are possible with no keyseat, shallow keyseat, or setscrew at angle to keyseat.

1.00 INCH (25.40mm) PITCH DUPLEX

ISO 16B-2
METRIC 80-2

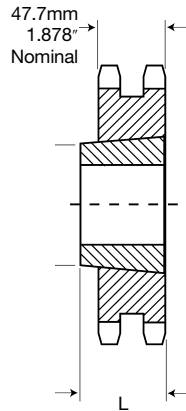
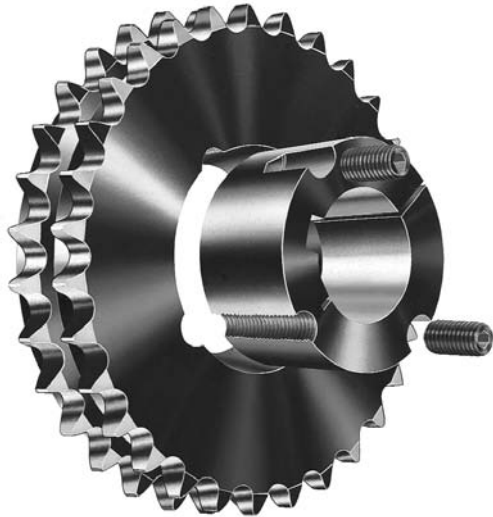

TYPE A

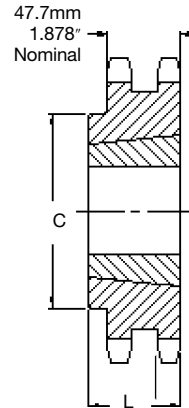

TYPE B

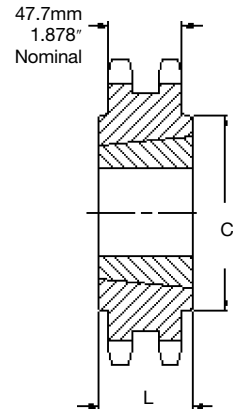

TYPE C

CHAIN DATA:

BS 228/15
ISO 16B-2
PITCH: 25.40mm (1.00 in.)
ROLLER DIAMETER: 15.88mm (0.625 in.)
ROLLER WIDTH: 17.02mm (0.670 in.)
TENSILE: 8620 kilos (19,000 lbs.)

Duplex-Taper Bushed — Steel

No. Teeth	Pitch Diameter	Catalog Number	Bushing Number	Bore Max.	Dimension		Weight	
	MM			MM	MM	Rim Kilos	Bushing Kilos	
13	106.14	D16ATB13	1615	41.28	38.10		1.54	0.77
14	114.15	D16ATB14	2012	50.80	31.75		1.68	0.77
15	122.17	D16ATB15	2012	50.80	31.75		2.04	0.77
16	130.20	D16ATB16	2012	50.80	31.75		2.27	0.77
17	138.23	D16ATB17	2517	63.50	44.45		2.50	1.59
18	146.27	D16ATB18	2517	63.50	44.45		2.64	1.59
19	154.32	D16ATB19	3020	76.20	50.80	127.00	3.18	2.95
20	162.37	D16BTB20	3020	76.20	50.80	133.35	3.45	2.95
21	170.42	D16BTB21	3020	76.20	50.80	141.28	4.09	2.95
22	178.48	D16BTB22	3020	76.20	50.80	149.23	4.73	2.95
23	186.54	D16BTB23	3020	76.20	50.80	158.34	5.48	2.95
24	194.60	D16BTB24	3020	76.20	50.80	166.68	6.34	2.95
25	202.66	D16BTB25	3020	76.20	50.80	174.63	7.72	2.95
26	210.72	D16BTB26	3020	76.20	50.80	182.56	8.36	2.95
27	218.79	D16BTB27	3020	76.20	50.80	133.35	10.22	2.95
28	226.86	D16BTB28	3020	76.20	50.80	133.35	10.59	2.95
30	243.00	D16BTB30	3020	76.20	50.80	133.35	11.35	2.95
35	283.36	D16CTB35	3020	76.20	50.80	133.35	17.88	2.95
38	307.58	D16CTB38	3020	76.20	50.80	133.35	21.79	2.95
42	339.89	D16CTB42	3020	76.20	50.80	133.35	22.94	2.95
45	364.12	D16CTB45	3020	76.20	50.80	133.35	23.80	2.95
57	461.08	D16CTB57	3020	76.20	50.80	133.35	27.24	2.95
76	614.64	D16CTB76	3020	76.20	50.80	133.35	37.68	2.95
95	768.22	D16CTB95	3020	76.20	50.80	133.35	43.13	2.95
114	921.81	D16CTB114	3020	76.20	50.80	133.35	48.58	2.95

Maximum bores shown will accommodate standard keyseat and setscrew over keyseat. Slightly larger bores are possible with no keyseat, shallow keyseat, or setscrew at angle to keyseat.

Metric Sprockets



1.00 INCH (25.40mm) PITCH TRIPLEX

ISO **16B-3**
METRIC **80-3**

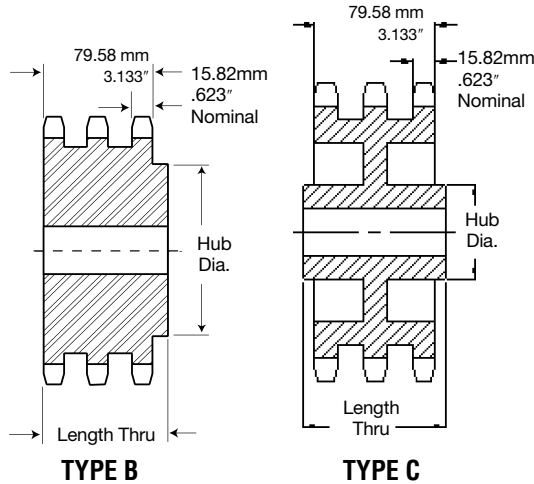

CHAIN DATA:
BS 228/15
ISO 16B-3
PITCH: 25.40mm (1.00 in.)
ROLLER DIAMETER: 15.88mm (0.625 in.)
ROLLER WIDTH: 17.02mm (0.670 in.)
TENSILE: 12,930 kilos (28,500 lbs.)

SPROCKETS

Triplex-Type B/C — Steel

No. Teeth	Pitch Diameter MM	Catalog Number	Bore		Hub		Weight (Approx.) Kilos
			Stock MM	Max. MM	Dia. MM	Thru MM	
11	90.16	E16B11	25	42	63	100	2.72
12	98.14	E16B12	25	45	72	100	3.59
13	106.14	E16B13	25	52	80	100	4.13
14	114.15	E16B14	25	58	88	100	4.68
15	122.17	E16B15	25	62	96	100	5.54
16	130.20	E16B16	30	66	104	100	6.81
17	138.23	E16B17	30	74	112	100	8.07
18	146.27	E16B18	30	80	120	100	9.99
19	154.32	E16B19	30	84	128	100	10.89
20	162.37	E16B20	30	85	130	100	11.80
21	170.42	E16B21	30	85	130	100	13.61
22	178.48	E16B22	30	85	130	100	14.07
23	186.54	E16B23	30	85	130	100	14.97
24	194.60	E16B24	30	85	130	100	16.34
25	202.66	E16B25	30	85	130	100	17.70
26	210.72	E16B26	30	85	130	100	19.98
27	218.79	E16B27	30	85	130	100	21.57
28	226.86	E16B28	30	85	130	100	23.15
29	234.93	E16B29	30	85	130	100	24.74
30	243.00	E16B30	32	95	140	105	26.33
35	283.36	E16B35	32	95	140	105	36.06
36	291.43	E16B36	32	95	140	105	38.06
38	307.58	E16C38	32	97	152	114	41.45
42	339.89	E16C42	40	97	152	114	38.51
45	364.12	E16C45	40	97	152	114	41.91
57	461.08	E16C57	40	107	159	120	51.35
60	485.33	E16C60	40	107	159	120	58.06
68	549.98	E16C68	40	107	159	120	63.50
76	614.64	E16C76	40	107	159	120	77.11
95	768.22	E16C95	40	114	171	127	100.70
114	921.81	E16C114	40	114	171	127	120.84

Maximum bores shown will accommodate standard keyseat and setscrew over keyseat. Slightly larger bores are possible with no keyseat, shallow keyseat, or setscrew at angle to keyseat.

ISO **20B-1**
METRIC **100**

1.25 INCH (31.75mm) PITCH **SIMPLEX**

CHAIN DATA:

BS 228/17
ISO 20B-1
PITCH: 31.75mm (1.250 in.)
ROLLER DIAMETER: 19.05mm (0.750 in.)
ROLLER WIDTH: 19.56mm (0.770 in.)
TENSILE: 6580 kilos (14,500 lbs.)

Simplex-Type A — Steel

Simplex-Type B/C — Steel

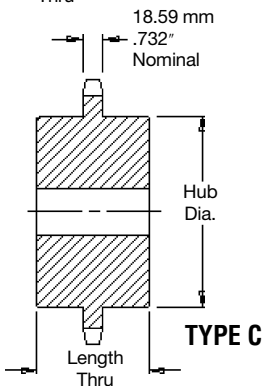
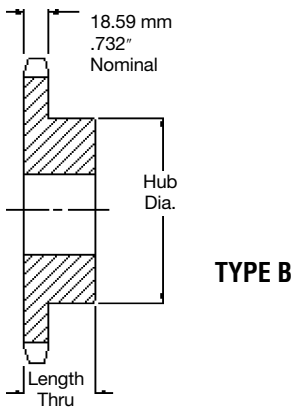
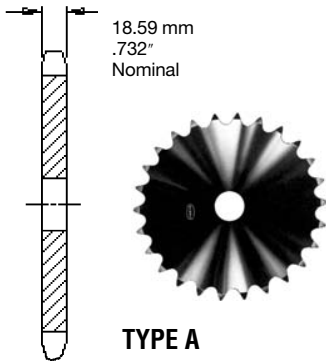

No. Teeth	Pitch Diameter MM	Catalog Number	Bore		Hub		Weight (Approx.) Kilos	Catalog Number	Bore Stock MM	Weight (Approx.) Kilos
			Stock MM	Max. MM	Dia. MM	Thru MM				
8	82.97	20B8	25	57	48	48	1.04	20A8	25	0.63
9	92.83	20B9	25	57	58	48	1.45	20A9	25	0.95
10	102.75	20B10	25	60	69	48	1.86	20A10	25	1.27
11	112.70	20B11	25	70	79	48	2.40	20A11	25	1.59
12	122.67	20B12	25	76	90	48	2.95	20A12	25	1.91
13	132.67	20B13	25	76	98	41	3.00	20A13	25	2.18
14	142.68	20B14	25	76	106	41	3.40	20A14	25	2.49
15	152.71	20B15	25	76	114	44	4.31	20A15	25	2.68
16	162.75	20B16	25	76	114	44	4.63	20A16	24	3.08
17	172.79	20B17	32	76	114	44	4.99	20A17	24	3.54
18	182.84	20B18	32	76	114	44	5.44	20A18	30	3.81
19	192.90	20B19	32	76	114	51	5.90	20A19	30	4.31
20	202.96	20B20	32	76	114	51	6.35	20A20	30	4.58
21	213.03	20B21	32	76	114	51	7.03	20A21	32	5.17
22	223.10	20B22	32	76	114	51	7.71	20A22	32	5.72
23	233.17	20B23	32	84	114	51	8.16	20A23	32	5.99
24	243.25	20B24	32	84	114	51	8.62	20A24	32	6.62
25	253.32	20B25	32	84	114	51	9.07	20A25	32	6.94
26	263.41	20B26	32	84	127	51	9.53	20A26	32	7.62
27	273.49	20B27	32	84	127	51	10.43	20A27	32	8.35
28	283.57	20B28	32	84	127	51	11.34	20A28	32	8.85
29	293.66	20B29	32	84	127	51	11.76	20A29	32	9.43
30	303.75	20B30	32	84	127	51	12.02	20A30	32	9.98
31	313.83	20B31	32	84	127	51	12.77	20A31	32	10.73
32	323.92	20B32	32	84	127	51	13.52	20A32	32	11.49
33	334.01	20B33	32	84	127	51	14.59	20A33	32	12.24
34	344.10	20B34	32	84	127	51	15.66	20A34	32	13.00
35	354.20	20B35	32	84	127	64	16.74	20A35	32	13.75
36	364.29	20B36	32	84	127	64	17.51	20A36	32	14.50
37	374.38	20B37	32	84	127	64	18.17	20A37	32	15.25
38	384.48	20B38	32	84	127	64	18.82	20A38	32	16.01
39	394.57	20B39	32	84	127	64	19.78	20A39	32	16.76
40	404.67	20B40	32	84	127	64	21.27	20A40	32	17.52
41	414.77	20B41	32	84	127	64	22.07	20A41	32	18.27
42	424.88	20B42	32	84	127	64	22.86	20A42	32	19.03
43	434.96	20B43	32	84	127	64	23.40	20A43	32	19.78
44	445.06	20B44	32	84	127	64	23.95	20A44	32	20.53
45	455.15	20B45	32	84	127	64	24.49	20A45	32	21.29
46	465.25	20B46	32	84	127	64	26.31	20A46	32	22.04
47	475.35	20B47	32	84	127	64	28.12	20A47	32	22.79
48	485.45	20B48	40	102	152	64	29.94	20A48	32	23.55
49	495.55	20B49	40	102	152	64	31.76	20A49	32	24.30
50	505.65	20B50	40	102	152	64	33.57	20A50	32	25.06
51	515.75	20B51	40	102	152	64	35.39	20A51	40	24.43
52	525.85	20B52	40	102	152	64	37.21	20A52	40	25.85
53	535.95	20B53	40	102	152	64	39.02	20A53	40	27.27
54	546.05	20C54	40	102	152	82	32.90	20A54	40	25.70
55	556.15	20C55	40	102	152	82	34.77	20A55	40	30.12
56	566.25	20C56	40	102	152	82	36.63	20A56	40	31.34
57	576.35	20C57	40	102	152	82	38.50	20A57	40	32.96
58	586.45	20C58	40	102	152	82	40.37	20A58	40	35.80
59	596.56	20C59	40	102	152	82	42.24	20A59	40	37.22
60	606.66	20C60	40	102	152	82	44.10	20A60	40	38.64
70	707.68	20C70	40	133	178	95	65.36	20A70	40	52.85
72	727.89	20C72	40	133	178	95	67.23	20A72	40	55.70
76	768.30	20C76	40	133	178	95	70.98	20A76	40	61.38
80	808.71	20C80	40	133	178	95	74.70	20A80	40	67.06
84	849.13	20C84	40	133	178	95	78.43	20A84	40	72.75
90	909.76	20C90	40	133	178	95	84.03	20A90	40	81.27
95	960.28	20C95	40	133	178	114	117.18	20A95	40	102.42
96	970.38	20C96	40	133	178	114	117.56	20A96	40	103.84
114	1152.27	20C114	40	133	178	114	124.40	20A114	40	130.84

Maximum bores shown will accommodate standard keyseat and setscrew over keyseat. Slightly larger bores are possible with no keyseat, shallow keyseat, or setscrew at angle to keyseat.

SPROCKETS

Metric Sprockets

1.25 INCH (31.75mm) PITCH SIMPLEX

ISO 20B-1
METRIC 100

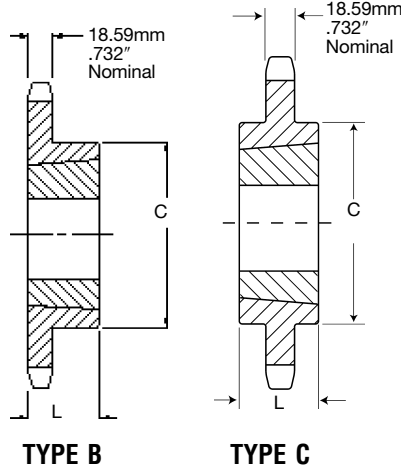

CHAIN DATA:

BS 228/17
ISO 20B1
PITCH: 31.75mm (1.250 in.)
ROLLER DIAMETER: 19.05mm (0.750 in.)
ROLLER WIDTH: 19.56mm (0.770 in.)
TENSILE: 6580 kilos (14,500 lbs.)

SPROCKETS

Simplex-Taper Bushed — Steel

No. Teeth	Pitch Diameter MM	Catalog Number	Bushing Number	Bore Max. MM	Dimension		Weight	
					L MM	C MM	Rim Kilos	Bushing Kilos
11	112.70	20BTB11H	1615	41.28	38.10	62.69	1.22	0.54
12	122.67	20BTB12H	1615	41.28	38.10	70.64	1.41	0.54
13	132.67	20BTB13H	2012	50.80	31.75	90.47	1.45	0.77
14	142.68	20BTB14H	2012	50.80	31.75	90.47	1.63	0.77
15	152.71	20BTB15H	2517	63.50	44.45	107.95	2.31	1.59
16	162.75	20BTB16H	2517	63.50	44.45	107.95	2.72	1.59
17	172.79	20BTB17H	2517	63.50	44.45	107.95	3.27	1.59
18	182.84	20BTB18H	2517	63.50	44.45	107.95	3.63	1.59
19	192.90	20BTB19H	2517	63.50	44.45	107.95	4.09	1.59
20	202.96	20BTB20H	2517	63.50	44.45	107.95	4.40	1.59
21	213.03	20BTB21H	2517	63.50	44.45	107.95	4.54	1.59
22	223.10	20BTB22H	2517	63.50	44.45	107.95	4.77	1.59
23	233.17	20BTB23H	2517	63.50	44.45	107.95	5.58	1.59
24	243.25	20BTB24H	2517	63.50	44.45	107.95	6.13	1.59
25	253.32	20BTB25H	2517	63.50	44.45	107.95	6.95	1.59
26	263.41	20BTB26H	2517	63.50	44.45	107.95	7.35	1.59
28	283.57	20BTB27H	3020	76.20	50.80	133.35	7.90	2.95
30	303.75	20BTB30H	3020	76.20	50.80	133.35	9.62	2.95
32	323.92	20BTB32	3020	76.20	50.80	133.35	11.03	2.95
35	354.20	20BTB35	3020	76.20	50.80	133.35	13.15	2.95
36	364.29	20BTB36	3020	76.20	50.80	133.35	13.86	2.95
38	384.48	20BTB38	3020	76.20	50.80	133.35	15.98	2.95
40	404.67	20BTB40	3020	76.20	50.80	133.35	19.43	2.95
45	455.15	20BTB45	3020	76.20	50.80	133.35	25.18	2.95
48	485.45	20BTB48	3020	76.20	50.80	133.35	28.62	2.95
54	546.05	20BTB54	3020	76.20	50.80	133.35	35.52	2.95
57	576.35	20BTB57	3020	76.20	50.80	133.35	37.82	2.95
60	606.66	20BTB60	3020	76.20	50.80	133.35	41.27	2.95
70	707.68	20CTB70	3535	88.90	88.90	171.45	51.56	6.35
72	727.89	20CTB72	3535	88.90	88.90	171.45	53.97	6.35
76	768.30	20CTB76	3535	88.90	88.90	171.45	60.33	6.35
80	808.71	20CTB80	3535	88.90	88.90	171.45	66.23	6.35
84	849.13	20CTB84	3535	88.90	88.90	171.45	73.48	6.35
90	909.76	20CTB90	3535	88.90	88.90	171.45	94.33	6.35
95	960.28	20CTB95	3535	88.90	88.90	171.45	96.16	6.35

Sprockets with "H" suffix have hardened teeth.

ISO **20B-2**
METRIC **100-2**

1.25 INCH (31.75mm) PITCH **DUPLEX**

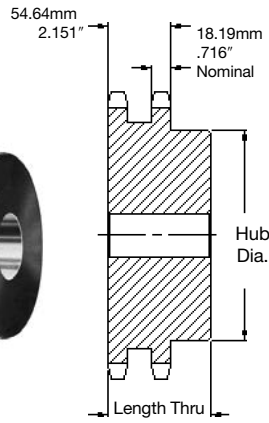

TYPE B

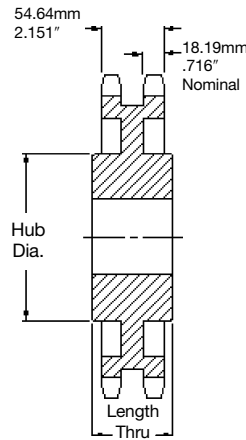

TYPE C

CHAIN DATA:

BS 228/17
ISO 20B-2
PITCH: 31.75mm (1.250 in.)
ROLLER DIAMETER: 19.05mm (0.750 in.)
ROLLER WIDTH: 19.56mm (0.770 in.)
TENSILE: 13,160 kilos (29,000 lbs.)

Duplex-Type B/C — Steel

No. Teeth	Pitch Diameter MM	Catalog Number	Bore		Hub		Weight (Approx.) Kilos
			Stock MM	Max. MM	Dia. MM	Thru MM	
10	102.75	D20B10	20	45	69	75	2.90
11	112.70	D20B11	20	52	79	80	3.67
12	122.67	D20B12	20	60	90	80	4.31
13	132.67	D20B13	20	64	100	80	5.53
14	142.68	D20B14	20	73	110	80	6.62
15	152.71	D20B15	20	80	120	80	7.76
16	162.75	D20B16	25	80	120	80	9.12
17	172.79	D20B17	25	80	120	80	10.44
18	182.84	D20B18	25	80	120	80	11.71
19	192.90	D20B19	25	80	120	80	12.92
20	202.96	D20B20	25	80	120	80	15.43
21	213.03	D20B21	25	92	140	80	16.55
22	223.10	D20B22	25	92	140	80	17.70
23	233.17	D20B23	25	92	140	80	19.05
24	243.25	D20B24	32	96	145	80	20.43
25	253.32	D20B25	32	96	145	80	21.77
26	263.41	D20B26	32	96	145	80	23.15
27	273.49	D20B27	32	96	145	80	24.97
28	283.57	D20B28	32	96	145	80	26.78
30	303.75	D20B30	32	96	145	80	30.41
32	323.92	D20B32	32	96	145	80	32.22
35	354.20	D20C35	32	100	152	108	34.02
36	364.29	D20C36	32	100	152	108	34.70
38	384.48	D20C38	32	100	152	114	43.72
42	424.86	D20C42	40	100	152	114	43.55
45	455.15	D20C45	40	100	152	114	46.72
57	576.35	D20C57	40	100	191	127	64.10
60	606.66	D20C60	40	125	191	127	79.38
68	687.48	D20C68	40	125	191	127	87.74
76	768.30	D20C76	40	125	191	127	96.11
80	808.71	D20C80	40	125	191	127	100.30
95	960.28	D20C95	40	125	191	127	115.98
114	1152.26	D20C114	40	125	191	127	135.85

Maximum bores shown will accommodate standard keyseat and setscrew over keyseat. Slightly larger bores are possible with no keyseat, shallow keyseat, or setscrew at angle to keyseat.

Metric Sprockets

1.25 INCH (31.75mm) PITCH TRIPLEX

ISO **20B-3**
METRIC **100-3**

CHAIN DATA:

BS 228/17
ISO 20B-3
PITCH: 31.75mm (1.250 in.)
ROLLER DIAMETER: 19.05mm (0.750 in.)
ROLLER WIDTH: 19.56mm (0.770 in.)
TENSILE: 19,740 kilos (43,500 lbs.)

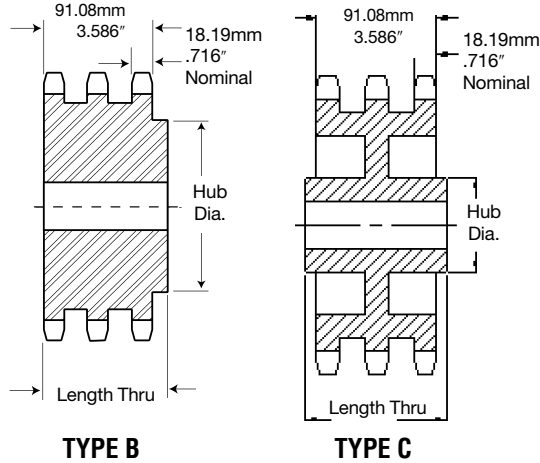

TYPE B

TYPE C

Triples-Type B/C — Steel

No. Teeth	Pitch Diameter MM	Catalog Number	Bore		Hub		Weight (Approx.) Kilos
			Stock	Max.	Dia.	Thru	
			MM	MM	MM	MM	
10	102.75	E20B10	25	47	69	110	3.95
11	112.70	E20B11	25	52	79	115	5.26
12	122.67	E20B12	25	60	90	115	6.21
13	132.67	E20B13	25	64	100	115	9.26
14	142.68	E20B14	25	73	110	115	9.76
15	152.71	E20B15	25	80	120	115	10.81
16	162.75	E20B16	25	80	120	115	12.76
17	172.79	E20B17	25	80	120	115	14.76
18	182.84	E20B18	25	80	120	115	16.71
19	192.90	E20B19	25	80	120	115	19.13
20	202.96	E20B20	25	80	120	115	21.57
21	213.03	E20B21	25	92	140	115	23.36
22	223.10	E20B22	25	92	140	115	25.65
23	233.17	E20B23	25	92	140	115	27.90
24	243.25	E20B24	32	95	145	120	27.19
25	253.32	E20B25	32	95	145	120	27.90
26	263.41	E20B26	32	95	145	120	31.90
27	273.49	E20B27	32	95	145	120	35.90
28	283.57	E20B28	32	95	145	120	39.90
30	303.75	E20B30	32	95	145	120	47.90
32	323.92	E20B32	32	95	145	127	51.57
35	354.20	E20C35	32	97	152	127	57.29
36	364.29	E20C36	32	97	152	127	59.35
38	384.48	E20C38	40	97	152	127	62.56
42	424.86	E20C42	40	97	152	127	70.12
45	455.15	E20C45	40	97	152	127	75.84
57	576.35	E20C57	40	102	191	127	100.11
60	606.66	E20C60	40	102	191	127	104.86
68	687.48	E20C68	40	102	191	127	117.54
76	768.30	E20C76	40	102	191	127	130.21
80	808.71	E20C80	40	102	191	127	136.55
95	960.28	E20C95	40	102	191	127	160.31
114	1152.27	E20C114	40	102	191	127	190.41

Maximum bores shown will accommodate standard keyseat and setscrew over keyseat. Slightly larger bores are possible with no keyseat, shallow keyseat, or setscrew at angle to keyseat.

ISO **24B-1**
METRIC **120**

1.50 INCH (38.10mm) PITCH SIMPLEX

CHAIN DATA:

BS 228/18
ISO 24B-1
PITCH: 38.10mm (1.50 in.)
ROLLER DIAMETER: 25.40mm (1.00 in.)
ROLLER WIDTH: 25.40mm (1.00 in.)
TENSILE: 9980 kilos (22,000 lbs.)

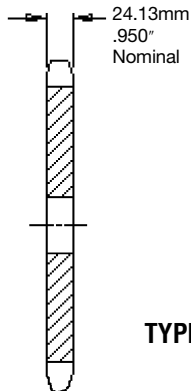

TYPE A

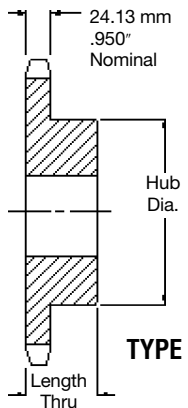

TYPE B

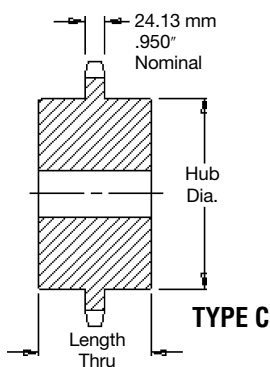

TYPE C

Simplex-Type B/C — Steel

Simplex-Type A — Steel

No. Teeth	Pitch Diameter MM	Catalog Number	Bore		Hub		Weight (Approx.) Kilos	Catalog Number	Bore Stock MM	Weight (Approx.) Kilos
			Stock MM	Max. MM	Dia. MM	Thru MM				
9	111.40	24B9	20	45	69	45	2.02	24A9	20	1.69
10	123.29	24B10	20	52	80	45	2.61	24A10	20	1.88
11	135.23	24B11	25	60	90	50	3.77	24A11	20	2.06
12	147.21	24B12	25	67	102	50	4.77	24A12	20	2.68
13	159.20	24B13	25	76	114	50	5.91	24A13	20	3.06
14	171.22	24B14	32	86	127	60	6.68	24A14	32	3.72
15	183.25	24B15	32	92	140	60	7.49	24A15	32	4.31
16	195.29	24B16	32	92	140	60	9.08	24A16	32	4.86
17	207.35	24B17	32	92	140	60	9.76	24A17	32	5.44
18	219.41	24B18	32	92	140	60	10.49	24A18	32	6.13
19	231.48	24B19	32	92	140	60	11.21	24A19	32	7.03
20	243.55	24B20	32	92	140	60	12.26	24A20	32	7.94
21	255.63	24B21	32	92	140	60	13.38	24A21	32	8.62
22	267.72	24B22	32	92	140	60	13.67	24A22	32	9.76
23	179.80	24B23	32	92	140	60	14.74	24A23	32	10.43
24	291.90	24B24	32	92	140	60	15.48	24A24	32	11.35
25	303.99	24B25	32	92	140	60	16.38	24A25	32	12.47
26	316.09	24B26	40	102	150	65	19.43	24A26	40	13.39
27	328.19	24B27	40	102	150	65	20.39	24A27	40	14.53
28	340.29	24B28	40	102	150	65	21.34	24A28	40	15.89
29	352.39	24B29	40	102	150	65	22.79	24A29	40	17.02
30	364.49	24B30	40	102	150	65	24.25	24A30	40	18.39
31	376.60	24B31	40	102	150	65	26.19	24A31	40	20.02
32	388.71	24B32	40	102	150	65	28.12	24A32	40	21.66
33	400.82	24B33	40	102	150	65	30.05	24A33	40	23.29
34	412.93	24B34	40	102	150	65	31.99	24A34	40	24.93
35	425.04	24B35	40	102	150	65	33.93	24A35	40	26.56
36	437.15	24B36	40	102	152	65	35.86	24A36	40	28.19
38	461.37	24B38	40	102	152	65	39.73	24A38	40	31.46
42	509.83	24C42	40	102	152	95	45.31	24A42	40	40.99
45	546.19	24C45	40	102	152	95	50.71	24A45	40	48.14
48	482.54	24C48	40	102	152	102	57.43	24A48	40	55.29
57	691.62	24C57	40	133	178	102	76.05	24A57	40	76.73
60	727.99	24C60	40	133	178	102	80.05	24A60	40	85.19
68	824.97	24C70	40	133	178	102	93.39	24A68	40	107.74
76	921.96	24C76	40	133	191	114	129.62	24A76	40	130.30

Maximum bores shown will accommodate standard keyseat and setscrew over keyseat. Slightly larger bores are possible with no keyseat, shallow keyseat, or setscrew at angle to keyseat.

Metric Sprockets

1.50 INCH (38.10mm) PITCH **SIMPLEX**

ISO **24B-1**
METRIC **120**

CHAIN DATA:

BS 228/18
ISO 24B-1
PITCH: 38.10mm (1.50 in.)
ROLLER DIAMETER: 25.40mm (1.00 in.)
ROLLER WIDTH: 25.40mm (1.00 in.)
TENSILE: 9980 kilos (22,000 lbs.)

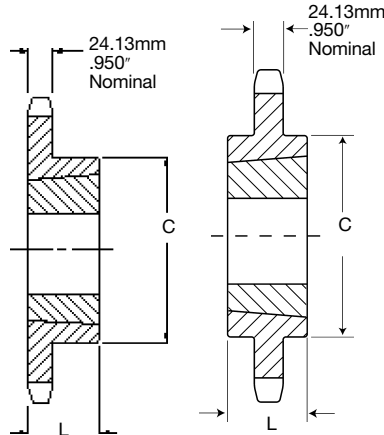

TYPE B

TYPE C

SPROCKETS

Simplex-Taper Bushed — Steel

No. Teeth	Pitch Diameter	Catalog Number	Bushing Number	Bore Max.	Dimension		Weight	
	MM				L	C	Rim Kilos	Bushing Kilos
11	135.23	24BTB11H	2012	50.80	31.75	90.49	2.28	0.77
12	147.21	24BTB12H	2012	50.80	31.75	90.49	2.49	0.77
13	159.20	24BTB13H	2517	63.50	44.45	107.95	2.77	1.59
14	171.22	24BTB14H	2517	63.50	44.45	107.95	3.54	1.59
15	183.25	24BTB15H	2517	63.50	44.45	107.95	4.31	1.59
16	195.29	24BTB16H	3020	76.20	50.80	133.35	4.77	2.95
17	207.35	24BTB17H	3020	76.20	50.80	133.35	5.45	2.95
18	219.41	24BTB18H	3020	76.20	50.80	133.35	6.13	2.95
19	231.48	24BTB19H	3020	76.20	50.80	133.35	6.81	2.95
20	243.55	24BTB20H	3020	76.20	50.80	133.35	7.49	2.95
21	255.63	24BTB21H	3020	76.20	50.80	133.35	7.94	2.95
22	267.72	24BTB22H	3020	76.20	50.80	133.35	8.75	2.95
23	279.80	24BTB23H	3020	76.20	50.80	133.35	9.53	2.95
24	291.90	24BTB24H	3020	76.20	50.80	133.35	10.67	2.95
25	303.99	24BTB25H	3020	76.20	50.80	133.35	11.80	2.95
26	316.09	24BTB26H	3020	76.20	50.80	133.35	12.93	2.95
27	328.19	24BTB27H	3020	76.20	50.80	133.35	13.50	2.95
28	340.29	24BTB28H	3020	76.20	50.80	133.35	14.70	2.95
29	352.29	24BTB29H	3020	76.20	50.80	133.35	14.75	2.95
30	364.49	24BTB30H	3020	76.20	50.80	133.35	15.20	2.95
32	388.71	24BTB32	3020	76.20	50.80	133.35	15.76	2.95
38	461.37	24BTB38	3030	76.20	76.20	139.70	24.97	4.18
40	485.60	24CTB40	3030	76.20	76.20	139.70	28.46	4.18
42	509.83	24CTB42	3030	76.20	76.20	139.70	31.95	4.18
45	546.19	24CTB45	3030	76.20	76.20	139.70	37.19	4.18
48	582.54	24CTB48	3030	76.20	76.20	139.70	42.43	4.18
50	606.78	24CTB50	3030	76.20	76.20	139.70	45.92	4.18
54	655.26	24CTB54	3535	88.90	88.90	165.10	63.32	6.36
57	691.62	24CTB57	3535	88.90	88.90	165.10	71.46	6.36
60	727.99	24CTB60	3535	88.90	88.90	165.10	79.60	6.36
68	824.97	24CTB68	3535	88.90	88.90	165.10	101.31	6.36
72	873.46	24CTB72	3535	88.90	88.90	165.10	112.17	6.36
76	921.96	24CTB76	3535	88.90	88.90	165.10	123.02	6.36
95	1152.33	24CTB95	4040	101.60	101.60	196.85	196.67	9.98
96	1164.46	24CTB96	4040	101.60	101.60	196.85	201.03	9.98
114	1382.72	24CTB114	4040	101.60	101.60	196.85	279.50	9.98

Sprockets with "H" suffix have hardened teeth.

ISO **24B-2**
METRIC **120-2**

1.50 INCH (38.10mm) PITCH DUPLEX

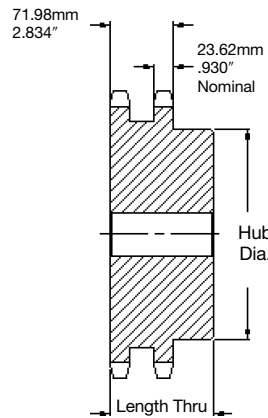

TYPE B

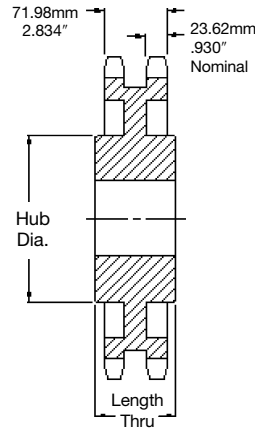

TYPE C

CHAIN DATA:

BS 228/18
ISO 24B-2
PITCH: 38.10mm (1.50 in.)
ROLLER DIAMETER: 25.40mm (1.00 in.)
ROLLER WIDTH: 25.40mm (1.00 in.)
TENSILE: 19,960 kilos (44,000 lbs.)

Duplex-Type B/C — Steel

No. Teeth	Pitch Diameter MM	Catalog Number	Bore		Hub		Weight (Approx.) Kilos
			Stock MM	Max. MM	Dia. MM	Thru MM	
11	135.23	D24B11	32	60	90	100	6.50
12	147.21	D24B12	32	67	102	100	8.13
13	159.20	D24B13	32	76	114	100	9.92
14	171.22	D24B14	32	84	128	100	11.98
15	183.25	D24B15	32	93	140	100	14.13
16	195.29	D24B16	32	100	150	100	16.35
17	207.35	D24B17	40	100	150	100	17.85
18	219.41	D24B18	40	108	160	100	20.35
19	231.48	D24B19	40	108	160	100	22.56
20	243.55	D24B20	40	108	160	100	24.78
21	255.63	D24B21	40	108	160	100	26.99
22	267.72	D24B22	40	108	160	102	29.74
23	279.80	D24B23	40	108	160	102	32.87
24	291.90	D24B24	40	108	160	102	36.00
25	303.99	D24B25	40	108	160	102	39.13
26	316.09	D24B26	40	108	160	102	42.26
27	328.19	D24B27	40	108	160	102	45.40
28	340.29	D24B28	40	108	160	102	48.53
29	352.39	D24B29	40	108	160	102	51.66
30	364.49	D24B30	40	108	160	102	54.79
32	388.71	D24B32	40	108	160	102	61.05
38	461.37	D24B38	40	137	190	152	72.01
40	485.60	D24C40	40	137	190	152	75.80
42	509.83	D24C42	40	137	190	152	79.59
45	546.19	D24C45	40	137	190	152	85.28
48	582.54	D24C48	40	137	190	152	90.97
50	606.78	D24C50	40	137	190	152	94.76
54	655.26	D24C54	40	161	238	159	127.46
57	691.62	D24C57	40	161	238	159	140.74
60	727.99	D24C60	40	161	238	159	154.02
68	824.97	D24C68	40	161	238	159	189.45
72	873.46	D24C72	40	161	238	159	207.16
76	921.96	D24C76	40	161	238	159	224.87
95	1152.33	D24C95	40	161	238	159	309.00
96	1164.46	D24C96	40	161	238	159	313.43
114	1382.72	D24C114	40	161	238	159	393.13

Maximum bores shown will accommodate standard keyseat and setscrew over keyseat. Slightly larger bores are possible with no keyseat, shallow keyseat, or setscrew at angle to keyseat.

Metric Sprockets

1.75 INCH (44.45mm) PITCH SIMPLEX

ISO 28B-1
METRIC 140

CHAIN DATA:

BS 228/20
ISO 28B-1
PITCH: 44.45mm (1.75 in.)
ROLLER DIAMETER: 27.94mm (1.10 in.)
ROLLER WIDTH: 30.99mm (1.22 in.)
TENSILE: 13,160 kilos (29,000 lbs.)

Simplex-Type B/C — Steel

No. Teeth	Pitch Diameter MM	Catalog Number	Bore		Hub		Weight (Approx.) Kilos	Catalog Number	Bore Stock MM	Weight (Approx.) Kilos
			Stock MM	Max. MM	Dia. MM	Thru MM				
11	157.77	28B11	40	73	112	70	5.27	28A11	32	3.18
12	171.74	28B12	40	84	125	70	6.40	28A12	32	3.95
13	185.74	28B13	40	93	140	70	8.22	28A13	32	4.31
14	199.76	28B14	40	93	140	60	9.13	28A14	32	4.77
15	213.79	28B15	40	108	160	60	11.40	28A15	40	5.45
16	227.84	28B16	40	108	160	64	12.76	28A16	40	6.81
17	241.91	28B17	40	108	160	64	13.65	28A17	40	7.71
18	255.98	28B18	40	108	160	64	13.65	28A18	40	8.63
19	270.06	28B19	40	108	160	64	15.01	28A19	40	9.53
20	284.14	28B20	40	108	160	64	16.84	28A20	40	10.44
21	298.24	28B21	40	108	160	64	18.19	28A21	40	11.79
22	312.34	28B22	40	108	160	64	19.11	28A22	40	13.17
23	326.44	28B23	40	108	160	64	20.46	28A23	40	14.06
24	340.54	28B24	40	108	160	64	21.84	28A24	40	15.44
25	354.65	28B25	40	108	160	64	22.73	28A25	40	16.78
26	368.77	28B26	40	108	160	64	26.83	28A26	40	18.61
27	382.88	28B27	40	108	160	64	27.74	28A27	40	20.43
28	397.00	28B28	40	108	160	64	30.29	28A28	40	20.88
29	411.12	28B29	40	108	160	64	31.74	28A29	40	23.06
30	425.24	28B30	40	108	160	64	32.73	28A30	40	25.17
32	453.49	28B32	40	134	180	76	34.84	28A32	40	31.02
38	538.27	28B38	40	134	178	102	51.25	28A38	40	48.58
40	566.54	28C40	40	134	178	102	52.84	28A40	40	52.80
42	594.81	28C42	40	134	178	102	54.43	28A42	40	57.02
45	637.22	28C45	40	134	178	102	60.55	28A45	40	63.35
48	679.63	28C48	40	134	178	102	62.72	28A48	40	69.68
54	764.47	28C54	40	134	178	127	74.60	28A54	40	82.34
57	806.89	28C57	40	134	178	127	81.77	28A57	40	88.67
60	849.32	28C60	40	134	178	127	88.94	28A60	40	97.97
68	962.47	28C68	40	137	191	127	108.05	28A68	40	122.79
72	1019.04	28C72	40	137	191	127	117.61	28A72	40	135.19
76	1075.62	28C76	40	137	191	127	127.17	28A76	40	147.60
95	1344.39	28C95	40	137	191	127	172.57	28A95	40	206.53
96	1358.53	28C96	40	137	191	127	174.96	28A96	40	209.63
114	1613.18	28C114	40	137	191	127	217.97	28A114	40	265.46

Simplex-Type A — Steel



29.44mm
1.159"
Nominal

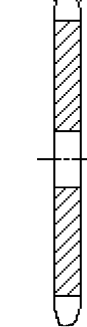

TYPE A



29.44mm
1.159"
Nominal

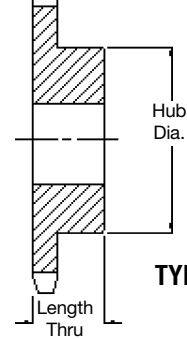

TYPE B

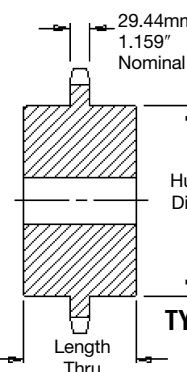

TYPE C

Maximum bores shown will accommodate standard keyseat and setscrew over keyseat. Slightly larger bores are possible with no keyseat, shallow keyseat, or setscrew at angle to keyseat.

SPROCKETS

ISO **28B-1**
METRIC **140**

1.75 INCH (44.45mm) PITCH SIMPLEX

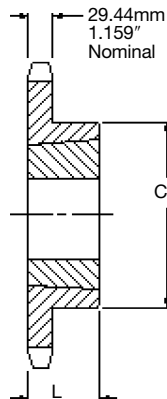

TYPE B

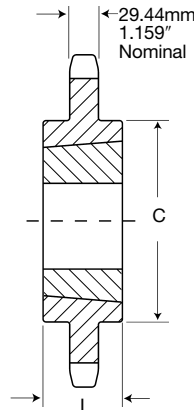

TYPE C

CHAIN DATA:

BS 228/20
ISO 28B-1
PITCH: 44.45mm (1.75 in.)
ROLLER DIAMETER: 27.94mm (1.10 in.)
ROLLER WIDTH: 30.99mm (1.22 in.)
TENSILE: 13,160 kilos (29,000 lbs.)

Simplex-Taper Bushed — Steel

No. Teeth	Pitch Diameter	Catalog Number	Bushing Number	Bore Max.	Dimension		Weight	
	MM			MM	L	C	Rim Kilos	Bushing Kilos
11	157.80	28BTB11H	2517	63.50	44.45	107.95	3.53	1.59
12	170.80	28BTB12H	2517	63.50	44.45	107.95	3.86	1.59
13	185.80	28BTB13H	3020	76.20	50.80	133.35	5.90	2.95
14	199.80	28BTB14H	3020	76.20	50.80	133.35	7.04	2.95
15	213.80	28BTB15H	3020	76.20	50.80	133.35	8.17	2.95
16	227.90	28BTB16H	3020	76.20	50.80	133.35	9.76	2.95
17	241.90	28BTB17H	3020	76.20	50.80	133.35	11.35	2.95
18	256.00	28BTB18H	3020	76.20	50.80	133.35	12.49	2.95
19	270.10	28BTB19H	3020	76.20	50.80	133.35	13.62	2.95
20	284.10	28BTB20H	3020	76.20	50.80	133.35	14.3	2.95
21	298.30	28BTB21H	3020	76.20	50.80	133.35	14.98	2.95
22	312.30	28BTB22H	3020	76.20	50.80	133.35	16.91	2.95
23	326.40	28BTB23H	3020	76.20	50.80	133.35	18.84	2.95
24	340.50	28BTB24H	3020	76.20	50.80	133.35	20.77	2.95
25	354.70	28BTB25H	3020	76.20	50.80	133.35	22.70	2.95
26	368.80	28BTB26H	3020	76.20	50.80	133.35	24.63	2.95
27	382.90	28BTB27	3020	76.20	50.80	133.35	26.56	2.95
28	397.00	28BTB28	3020	76.20	50.80	133.35	28.49	2.95
30	425.20	28BTB30	3020	76.20	50.80	133.35	32.35	2.95
32	453.49	28BTB32	3020	76.20	50.80	133.35	36.21	2.95
38	538.30	28BTB38	3535	88.90	88.90	165.10	45.40	6.36
40	566.55	28CTB40	3535	88.90	88.90	165.10	47.79	6.36
42	594.82	28CTB42	3535	88.90	88.90	165.10	50.18	6.36
45	637.21	28CTB45	4040	101.60	101.60	219.08	57.35	9.99
48	679.63	28CTB48	4040	101.60	101.60	219.08	61.17	9.99
54	764.46	28CTB54	4040	101.60	101.60	219.08	68.82	9.99
57	806.90	28CTB57	4040	101.60	101.60	219.08	72.64	9.99
60	849.33	28CTB60	4040	101.60	101.60	219.08	76.44	9.99
68	962.46	28CTB68	4040	101.60	101.60	219.08	86.63	9.99
72	1019.05	28CTB72	4040	101.60	101.60	219.08	91.73	9.99
76	1075.60	28CTB76	4040	101.60	101.60	219.08	96.83	9.99
95	1344.37	28CTB95	4040	101.60	101.60	219.08	121.03	9.99
96	1358.52	28CTB96	4040	101.60	101.60	219.08	122.31	9.99
114	1613.18	28CTB114	4040	101.60	101.60	219.08	145.24	9.99

Metric Sprockets



1.75 INCH (44.45mm) PITCH DUPLEX

ISO **28B-2**
METRIC **140-2**

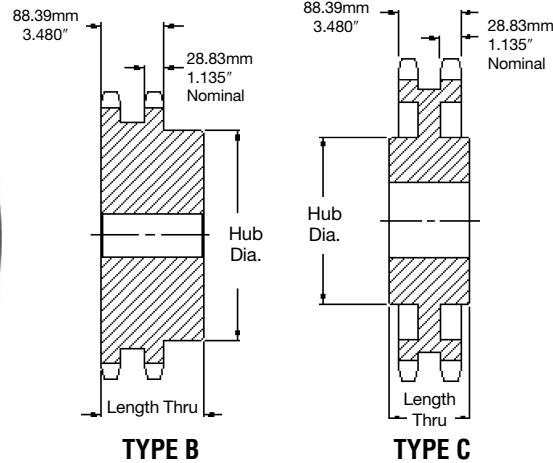

CHAIN DATA:

BS 228/20
ISO 28B-2
PITCH: 44.45mm (1.75 in.)
ROLLER DIAMETER: 27.94mm (1.10 in.)
ROLLER WIDTH: 30.99mm (1.22 in.)
TENSILE: 26,320 kilos (58,000 lbs.)

SPROCKETS

Duplex-Type B/C — Steel

No. Teeth	Pitch Diameter MM	Catalog Number	Bore		Hub		Weight (Approx.) Kilos
			Stock	Max.	Dia.	Thru	
			MM	MM	MM	MM	
11	157.77	D28B11	40	73	112	120	10.21
12	171.74	D28B12	40	84	125	120	13.02
13	185.74	D28B13	40	84	130	120	16.00
14	199.76	D28B14	40	87	135	120	19.28
15	213.79	D28B15	40	96	145	120	22.91
16	227.84	D28B16	40	108	160	120	26.92
17	241.91	D28B17	40	114	178	120	30.83
18	255.98	D28B18	40	114	178	120	34.74
19	270.06	D28B19	40	133	178	120	38.93
20	284.14	D28B20	40	133	178	120	44.27
21	298.24	D28B21	40	133	178	120	45.08
22	312.34	D28B22	40	133	178	120	48.15
23	326.44	D28B23	40	133	178	120	51.59
24	340.54	D28B24	40	133	178	120	55.03
25	354.65	D28B25	40	133	178	120	58.47
26	368.77	D28B26	40	133	178	120	64.06
28	397.00	D28B28	40	133	178	120	76.05
30	425.24	D28B30	40	133	178	120	89.16
32	453.49	D28B32	40	133	178	120	103.38
38	537.27	D28B38	40	133	191	159	97.53
40	566.54	D28C40	40	137	191	159	109.47
45	637.22	D28C45	40	137	191	159	137.32
48	679.63	D28C48	40	137	191	159	153.61
54	764.47	D28C54	40	162	241	181	204.44
57	806.89	D28C57	40	162	241	181	210.02
60	849.32	D28C60	40	162	241	181	230.82
68	962.47	D28C68	40	162	241	181	273.98
72	1019.04	D28C72	40	162	241	181	305.70
76	1075.62	D28C76	40	162	241	181	323.56

Maximum bores shown will accommodate standard keyseat and setscrew over keyseat. Slightly larger bores are possible with no keyseat, shallow keyseat, or setscrew at angle to keyseat.

ISO
METRIC

32B-1
160

2.00 INCH (50.80mm) PITCH SIMPLEX

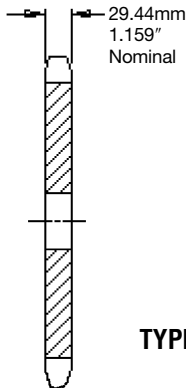

TYPE A

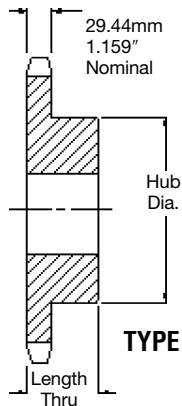

TYPE B

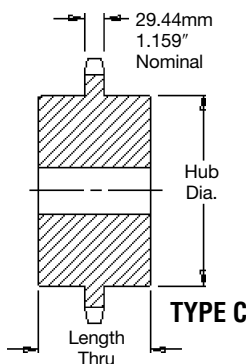

TYPE C

CHAIN DATA:

BS 228/22
ISO 32B-1
PITCH: 50.80mm(2.00 in.)
ROLLER DIAMETER: 29.21mm (1.15 in.)
ROLLER WIDTH: 30.99mm (1.22 in.)
TENSILE: 17,240 kilos (38,000 lbs.)

Simplex-Type B/C — Steel

Simplex-Type A — Steel

No. Teeth	Pitch Diameter MM	Catalog Number	Bore		Hub		Weight (Approx.) Kilos	Catalog Number	Bore Stock MM	Weight (Approx.) Kilos
			Stock MM	Max. MM	Dia. MM	Thru MM				
11	180.31	32B11	40	83	120	80	9.04	32A11	32	5.00
12	196.28	32B12	40	89	133	80	11.11	32A12	32	6.02
13	212.27	32B13	40	102	152	70	12.61	32A13	32	7.12
14	228.29	32B14	40	102	152	70	14.97	32A14	32	8.32
15	244.33	32B15	40	102	178	70	17.32	32A15	40	9.50
16	260.39	32B16	40	103	178	70	18.78	32A16	40	11.64
17	276.46	32B17	40	103	178	70	20.23	32A17	40	12.35
18	292.55	32B18	40	103	178	70	21.88	32A18	40	13.96
19	308.64	32B19	40	103	178	70	23.53	32A19	40	15.57
20	324.74	32B20	40	133	178	70	25.37	32A20	40	17.36
21	340.84	32B21	40	133	178	70	27.20	32A21	40	19.15
22	356.96	32B22	40	133	178	70	29.23	32A22	40	21.13
23	373.07	32B23	40	133	178	70	31.25	32A23	40	23.10
24	389.19	32B24	40	133	178	76	35.33	32A24	40	25.26
25	405.32	32B25	40	133	178	76	36.80	32A25	40	27.41
26	421.45	32B26	40	133	181	76	39.41	32A26	40	30.25
27	437.58	32B27	40	133	181	76	42.02	32A27	40	33.10
28	453.72	32B28	40	133	181	76	44.62	32A28	40	35.94
29	469.85	32B29	40	133	181	76	47.23	32A29	40	38.78
30	485.99	32B30	40	133	181	76	49.84	32A30	40	41.63
32	518.28	32B32	40	139	203	76	58.02	32A32	40	47.31
38	615.17	32B38	40	139	203	114	86.78	32A38	40	64.37
40	647.47	32C40	40	139	203	114	91.35	32A40	40	72.98
42	679.78	32C42	40	139	203	114	95.91	32A42	40	81.60
45	728.25	32C45	40	139	203	127	116.97	32A45	40	94.52
48	776.72	32C48	40	139	203	127	130.43	32A48	40	107.44
54	873.68	32C54	40	139	203	127	157.34	32A54	40	133.29
57	922.16	32C57	40	139	203	127	170.79	32A57	40	146.21
60	970.65	32C60	40	139	203	127	184.25	32A60	40	164.35
68	1099.96	32C68	40	139	203	127	220.13	32A68	40	212.73
72	1164.62	32C72	40	139	203	152	282.31	32A72	40	236.91
76	1229.28	32C76	40	139	203	152	297.99	32A76	40	261.10

Maximum bores shown will accommodate standard keyseat and setscrew over keyseat. Slightly larger bores are possible with no keyseat, shallow keyseat, or setscrew at angle to keyseat.

Metric Sprockets

2.00 INCH (50.80mm) PITCH **SIMPLEX**

ISO **32B-1**
METRIC **160**

CHAIN DATA:

BS 228/22
ISO 32B-1
PITCH: 50.80mm (2.00 in.)
ROLLER DIAMETER: 29.21mm (1.15 in.)
ROLLER WIDTH: 30.99mm (1.22 in.)
TENSILE: 17,240 kilos (38,000 lbs.)

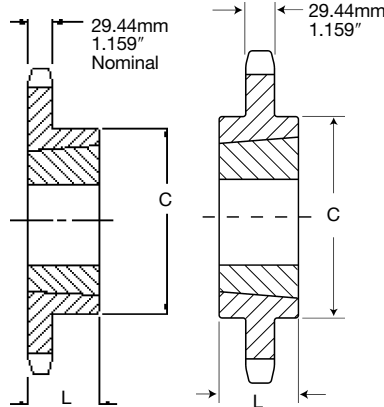

TYPE B

TYPE C

SPROCKETS

Simplex-Taper Bushed — Steel

No. Teeth	Pitch Diameter	Catalog Number	Bushing Number	Bore Max.	Dimension		Weight	
	MM				L	C	Rim	Bushing
				MM	MM	MM	Kilos	Kilos
11	180.31	32BTB11H	2517	63.50	44.45	107.95	4.51	1.59
12	196.28	32BTB12H	3020	76.20	50.80	133.35	5.27	2.95
13	212.27	32BTB13H	3020	76.20	50.80	133.35	6.38	2.95
14	228.29	32BTB14H	3020	76.20	50.80	133.35	6.87	2.95
15	244.33	32BTB15H	3535	88.90	88.90	165.10	11.80	6.36
16	260.39	32BTB16H	3535	88.90	88.90	165.10	13.38	6.36
17	276.46	32BTB17H	3535	88.90	88.90	165.10	14.98	6.36
18	292.55	32BTB18H	3535	88.90	88.90	165.10	16.12	6.36
19	308.64	32BTB19H	3535	88.90	88.90	165.10	17.25	6.36
20	324.74	32BTB20H	3535	88.90	88.90	165.10	21.10	6.36
21	340.84	32BTB21H	3535	88.90	88.90	165.10	24.94	6.36
22	356.96	32BTB22H	3535	88.90	88.90	165.10	27.79	6.36
23	373.07	32BTB23H	3535	88.90	88.90	165.10	30.64	6.36
24	389.19	32BTB24H	3535	88.90	88.90	165.10	33.48	6.36
25	405.32	32BTB25H	3535	88.90	88.90	165.10	36.32	6.36
26	421.45	32BTB26H	3535	88.90	88.90	165.10	39.16	6.36
27	437.58	32BTB27	3535	88.90	88.90	165.10	42.00	6.36
28	453.72	32BTB28	3535	88.90	88.90	165.10	44.84	6.36
30	486.99	32BTB30	3535	88.90	88.90	165.10	50.52	6.36
32	518.28	32BTB32	3535	88.90	88.90	165.10	56.20	6.36
38	615.17	32BTB38	4040	101.60	101.60	219.08	68.10	10.00
40	647.47	32CTB40	4040	101.60	101.60	219.08	77.08	10.00
45	728.25	32CTB45	4040	101.60	101.60	219.08	99.53	10.00
48	776.72	32CTB48	4040	101.60	101.60	219.08	113.01	10.00
54	873.68	32CTB54	4040	101.60	114.30	219.08	139.95	10.00
57	922.16	32CTB57	4545	114.30	114.30	247.65	136.20	13.62
60	970.65	32CTB60	4545	114.30	114.30	247.65	158.84	13.62
64	1035.30	32CTB64	4545	114.30	114.30	247.65	189.03	13.62
70	1132.29	32CTB70	4545	114.30	114.30	247.65	234.32	13.62

ISO **32B-2**
METRIC **160-2**

2.00 INCH (50.80mm) PITCH DUPLEX

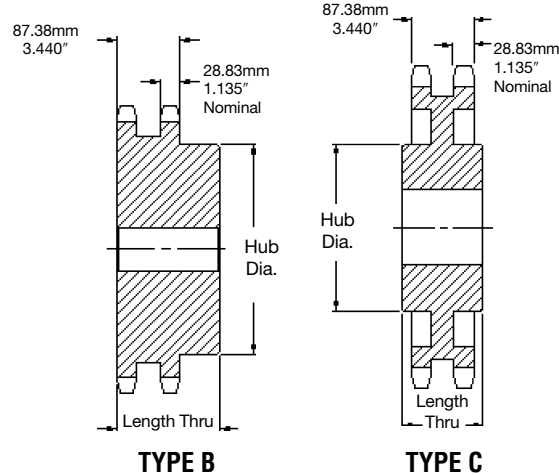

CHAIN DATA:

BS 228/22
ISO 32B-2
PITCH: 50.80mm (2.00 in.)
ROLLER DIAMETER: 29.21mm (1.15 in.)
ROLLER WIDTH: 30.99mm (1.22 in.)
TENSILE: 34,480 kilos (76,000 lbs.)

Duplex-Type B/C — Steel

No. Teeth	Pitch Diameter MM	Catalog Number	Bore		Hub		Weight (Approx.) Kilos
			Stock	Max.	Dia.	Thru	
			MM	MM	MM	MM	
11	180.31	D32B11	40	80	125	120	10.42
12	196.28	D32B12	40	89	133	120	16.32
13	212.27	D32B13	40	96	145	120	21.77
14	228.29	D32B14	40	103	155	120	26.31
15	244.33	D32B15	40	106	160	120	30.84
16	260.39	D32B16	40	120	178	120	34.02
17	276.46	D32B17	40	120	178	120	41.28
18	292.55	D32B18	40	120	178	120	43.55
19	308.64	D32B19	40	120	178	120	48.53
20	324.74	D32B20	40	130	191	120	53.98
21	340.84	D32B21	40	130	191	120	58.97
22	356.96	D32B22	40	130	191	120	63.96
23	373.07	D32B23	40	130	191	120	71.21
24	389.19	D32B24	40	130	191	120	77.57
25	405.32	D32B25	40	130	191	120	84.82
26	421.45	D32B26	40	130	191	120	91.17
27	437.58	D32B27	40	130	191	120	97.52
28	453.72	D32B28	40	130	191	120	101.13
30	485.99	D32B30	40	130	191	120	116.57
38	615.17	D32B38	40	178	254	181	170.25
40	647.47	D32C40	40	178	254	181	177.46
45	728.25	D32C45	40	178	254	181	195.50
48	776.72	D32C48	40	178	254	181	204.51
54	873.68	D32C54	40	178	254	181	222.53
57	922.16	D32C57	40	178	254	181	231.54
60	970.65	D32C60	40	178	254	181	255.83
76	1229.28	D32C76	40	178	254	181	292.83

Maximum bores shown will accommodate standard keyseat and setscrew over keyseat. Slightly larger bores are possible with no keyseat, shallow keyseat, or setscrew at angle to keyseat.

SPROCKET ENGINEERING DATA

ROLLER CHAIN DIMENSIONS
SPROCKET TOOTH DIMENSIONS
MAXIMUM HUB RECOMMENDATIONS
APPLICATION AND SELECTION
HARDENING
CHAIN LENGTH CALCULATION
SPEED RATIOS
SPROCKET DIAMETERS
HORSEPOWER RATINGS

SPROCKETS

American sprocket manufacturers have adopted 4 specific types of sprocket construction styles as American Standards. In addition to the standard sprockets, special sprockets may be available in the same styles.

- Style A** - Flat sprocket with no hub extension either side.
- Style B** - Sprocket with hub extension one side.
- Style C** - Sprocket with hub extension both sides.
- Style D** - Sprocket with a detachable bolt on hub attached to a plate.

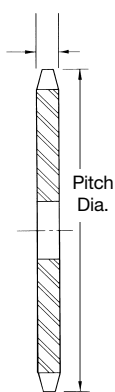

**Single
Type A Hub**

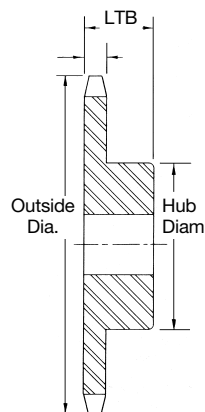

**Single
Type B Hub**

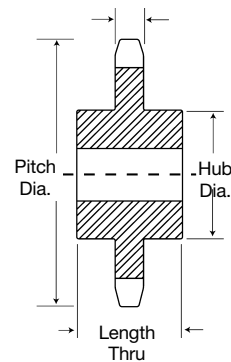

**Single
Type C Hub**

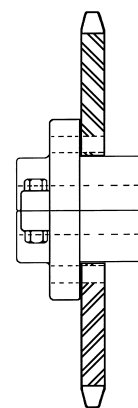

**Single
Type D Hub**

Multiple Strand Sprockets -

Listed using a letter prefix starting with the letter "D" for Double Strand, "E" for Triple Strand, and "F" for Quadruple, etc. They also have the same hub configuration letter designation listed on previous page. In addition to the four specific types, sprockets may also be made in various other styles.



Double



Triple

Five common styles are:

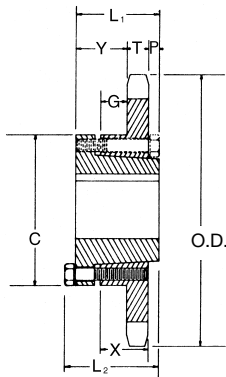

QD

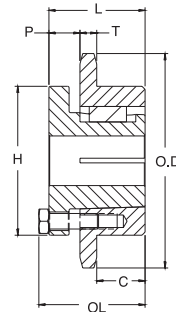

MST®

The **QD** (quick detachable) sprocket; here a tapered bushing is bolted into the bore machined in the sprocket. This bushing, when inserted into the sprocket, compresses onto the shaft providing a tight grip.

The **MST®** (*Martin Split Taper®*) is another style of bushed sprocket. The bushing is similar to the QD style except it has an external key that fits into the driven product.

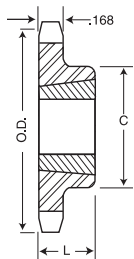

TB

The **TB** (taper bushed) sprocket is another style of an interchangeable bushed sprocket, which provides a positive grip on a driven shaft.

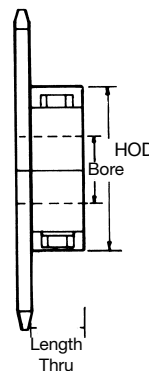

Split

A **split** type sprocket is used in place of solid type to allow quick installation without disruption of shaft and alignment.



Shear Pin Sprocket

A **shear pin** type hub is bolted to a sprocket providing an overload device; as sprocket torque ratings are exceeded the shear device disengages sprocket from drive.

Sprocket Nomenclature

Sprocket nomenclatures provide the chain pitch written to the left of the hub style code letter followed by the number of teeth in the sprocket. If the sprocket is to be multiple strand, the prefix code letter is added to the beginning of the part number.

A suffix of H is added if the teeth are to be heat treated. If the sprocket is to be bored for QD, Taper Bushed or MST, the center hub letter is changed. For QD and MST styles the letter designation of the bushing is used in lieu of the hub style code. If a taper bushing is to be used, the two letters TB are added behind the hub code letter.

In some instances, the material a sprocket is to be manufactured from will be added into the part number as a suffix.

For example:

- SS** - Stainless Steel Material
- NM** - Non-Metallic
- BR** - Brass or Bronze Material
- CD** - Cadmium Plated
- Zi** - Zinc Plated
- Ni** - Nickel Plated
- CH** - Chrome Plated

If the part is to be used with a shear pin device, the center hub style letter is substituted with an SP.

Most manufacturers of sprockets conform to the ANSI (American Standards Institute) and *Martin* conforms to the Type II tooth form as given in the standard B29.1 - 1975. It is not necessary to show detailed tooth information on sprocket drawings, just specify ANSI standard tooth form.

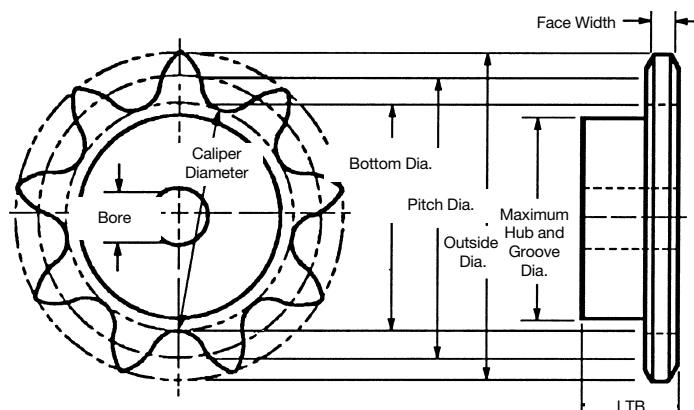

Sprocket Dimensional Specifications

Bottom Diameter (B.D.) - The diameter of a circle tangent to the bottoms of the tooth spaces.

Caliper Diameter - Since the bottom diameter of a sprocket with odd number of teeth cannot be measured directly, caliper diameters are the measurement across the tooth spaces nearly opposite.

Pitch Diameter (P.D.) - The diameter across to the pitch circle which is the circle followed by the centers of the chain pins as the sprocket revolves in mesh with the chain.

$$PD = \frac{PITCH}{\sin (180/Nt)}$$

Outside Diameter (O.D.) - The measurement from the tip of the sprocket tooth across to the corresponding point directly across the sprocket. It is comparatively unimportant as the tooth length is not vital to proper meshing with the chain. The outside diameter may vary depending on type of cutter used.

$$OD = (Pitch) (.6 + \cot [180 / Nt])$$

Hub Diameter (HOD) - That distance across the hub from one side to another. This diameter must not exceed the calculated diameter of the inside of the chain side bars.

Maximum Sprocket Bore - Maximum Sprocket Bore is determined by the required hub wall thickness for proper strength. Allowance must be made for keyway and setscrews.

Face Width - Face width is limited in its maximum dimension to allow proper clearance to provide for chain engagement and disengagement. The minimum width is limited to provide the proper strength to carry the imposed loads.

Length Thru Bore (LTB) - Length Thru Bore (or L.T.B.) must be sufficient to allow a long enough key to withstand the torque transmitted by the shaft. This also assures stability of the sprocket on the shaft.

Roller Chain Dimensions



SPROCKETS

ANSI Number	Roller Width	Roller Diam.	Inside Link Plate Height	Cottered Chain Width*	Riveted Chain Width*	Average Tensile Strength
STANDARD SERIES CHAIN						
25	1/8	.130	.237	.37	.34	875
25-2	1/8	.130	.237	.63	.59	1750
25-3	1/8	.130	.237	.88	.84	2626
35	3/16	.200	.356	.56	.50	2100
35-2	3/16	.200	.356	.96	.90	4200
35-3	3/16	.200	.356	1.36	1.31	6300
35-4	3/16	.200	.356	1.76	1.70	8400
35-5	3/16	.200	.356	2.16	2.11	10500
35-6	3/16	.200	.356	2.57	2.51	12600
40	1/4	.312	.475	.72	.67	3700
40-2	1/4	.312	.475	1.29	1.24	7400
40-3	1/4	.312	.475	1.85	1.80	11100
40-4	1/4	.312	.475	2.42	2.37	14800
40-6	1/4	.312	.475	3.56	3.51	22200
41	1/4	.306	.383	.65	.57	2000
50	1/2	.400	.594	.89	.83	6600
50-2	1/2	.400	.594	1.60	1.55	13200
50-3	1/2	.400	.594	2.31	2.26	19800
50-4	1/2	.400	.594	3.03	2.97	26400
50-5	1/2	.400	.594	3.75	3.69	33000
50-6	1/2	.400	.594	4.46	4.40	39600
60	3/4	.469	.712	1.11	1.04	8500
60-2	3/4	.469	.712	2.01	1.94	17000
60-3	3/4	.469	.712	2.91	2.84	25500
60-4	3/4	.469	.712	3.81	3.74	34000
60-5	3/4	.469	.712	4.71	4.64	42500
60-6	3/4	.469	.712	5.60	5.53	51000
80	1	.625	.950	1.44	1.32	14500
80-2	1	.625	.950	2.59	2.47	29000
80-3	1	.625	.950	3.74	3.62	43500
80-4	1	.625	.950	4.90	4.79	58000
80-5	1	.625	.950	6.06	5.94	72500
80-6	1	.625	.950	7.22	7.10	87000

*Dimensions are across pins.

ANSI Number	Roller Width	Roller Diam.	Inside Link Plate Height	Cottered Chain Width*	Riveted Chain Width*	Average Tensile Strength
STANDARD SERIES CHAIN						
100	1 1/2	.750	1.187	1.73	1.61	24000
100-2	1 1/2	.750	1.187	3.14	3.02	48000
100-3	1 1/2	.750	1.187	4.56	4.43	72000
100-4	1 1/2	.750	1.187	5.97	5.84	96000
100-5	1 1/2	.750	1.187	7.38	7.25	120000
100-6	1 1/2	.750	1.187	8.78	8.66	144000
120	1	.875	1.425	2.14	2.00	34000
120-2	1	.875	1.425	3.93	3.79	68000
120-3	1	.875	1.425	5.72	5.58	102000
120-4	1	.875	1.425	7.52	7.38	136000
120-5	1	.875	1.425	9.31	9.17	170000
120-6	1	.875	1.425	11.10	10.96	204000
140	1	1.000	1.662	2.31	2.14	46000
140-2	1	1.000	1.662	4.24	4.07	92000
140-3	1	1.000	1.662	6.16	6.00	138000
140-4	1	1.000	1.662	8.09	7.93	184000
140-6	1	1.000	1.662	11.94	11.78	276000
160	1 1/4	1.125	1.900	2.73	2.54	58000
160-2	1 1/4	1.125	1.900	5.04	4.85	116000
160-3	1 1/4	1.125	1.900	7.35	7.16	174000
160-4	1 1/4	1.125	1.900	9.66	9.47	232000
160-6	1 1/4	1.125	1.900	14.27	14.09	348000
180	1 3/8	1.406	2.137	3.15	2.88	76000
180-2	1 3/8	1.406	2.137	5.75	5.48	152000
180-3	1 3/8	1.406	2.137	8.34	8.07	228000
200	1 1/2	1.562	2.375	3.44	3.12	95000
200-2	1 1/2	1.562	2.375	6.26	5.94	190000
200-3	1 1/2	1.562	2.375	9.08	8.76	285000
200-4	1 1/2	1.562	2.375	11.90	11.58	380000
200-6	1 1/2	1.562	2.375	17.52	17.21	570000
240	1 3/4	1.875	2.812	4.06	3.72	130000
240-2	1 3/4	1.875	2.812	7.52	7.18	260000

*Dimensions are across pins.

STANDARD KEYWAYS AND SETSCREWS

Diameter of Shaft	Keyway Width x Depth	Setscrew	Diameter of Shaft	Keyway Width x Depth	Setscrew
1/2-3/16	1/8 x 1/16	10-24	2 3/16 - 2 3/4	3/8 x 3/16	3/8*
5/8-1/2	3/16 x 3/32	1/4	2 9/16 - 3 1/4	3/4 x 3/8	3/4*
1 1/16-1 1/4	1/4 x 1/8	5/16	3 3/16 - 3 3/4	3/4 x 3/8	3/4
1 3/16-1 3/4	3/16 x 3/32	5/16	3 3/8 - 4 1/2	1 x 1/2	3/4
1 1/2-1 3/4	3/8 x 3/16	3/8	4 3/8 - 5 1/2	1 1/4 x 3/8	3/4
1 5/8-2 1/4	1/2 x 1/4	1/2*	5 3/8 - 6 1/2	1 1/2 x 3/4	3/4

*Hub size may require smaller setscrews in some instances.

STANDARD BORE TOLERANCES

1" and Less	+ .001 - .000
1 1/16" to 2"	+ .002 - .000
2 1/16" to 3"	+ .003 - .000
3 1/16" & up	+ .004 - .000
Bores with closer tolerances will be supplied at a slight increase in price.	

Sprocket Tooth Dimensions



Sprocket Tooth Dimensions

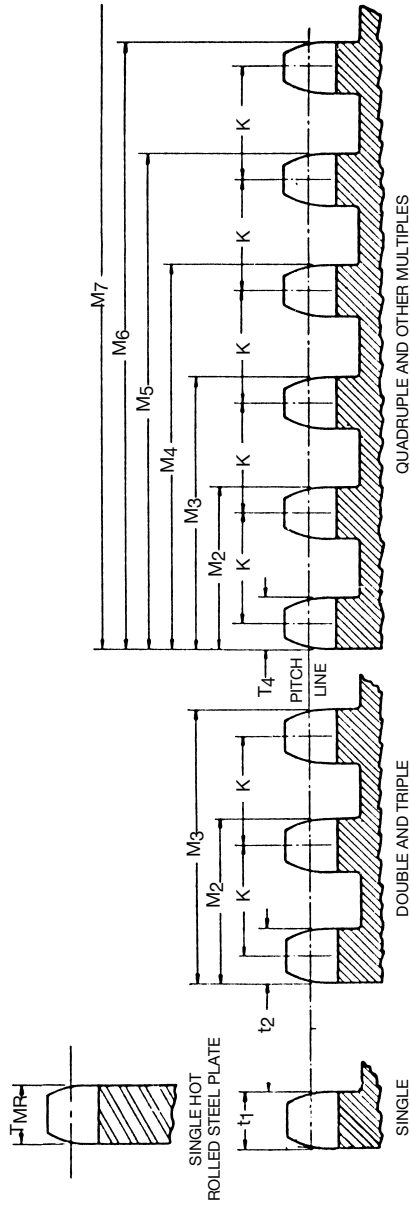

Dimensions in Inches

A.S.A. Chain No.	Chain Data For All Sprockets			For 4 or more Strands										Minus Tolerance on T_{HR}				
	Pitch P	Roller Width W	Roller Diameter	Double and Triple Strand			M ₄	M ₅	M ₆	M ₈	M ₁₀	M ₁₂	M ₁₆		K			
				I ₂	M ₂	M ₃												
25	1/4	3/8	1.30	.107	.359	.611	.096	.348	.600	.852	1.104	1.356	1.860	2.364	2.868	3.876	.252	.007
35	3/8	1/2	.200	.162	.561	.960	.149	.548	.947	1.346	1.745	2.144	2.942	3.740	4.538	6.134	.399	.008
41	1/2	5/8	.306	†	†	†	†	†	†	†	†	†	†	†	†	†	†	.009
40	5/8	3/4	.312	.275	.841	1.407	.256	.822	1.388	1.954	2.520	3.086	4.218	5.250	6.482	8.746	.566	.009
50	3/4	7/8	.400	.332	1.045	1.758	.311	1.024	1.737	2.450	3.163	3.876	5.302	6.728	8.154	11.006	.713	.036
60	7/8	1	.469	.444	1.341	2.238	.418	1.315	2.212	3.108	4.006	4.903	6.697	8.491	10.258	13.873	.897	.011
80	1	1 1/8	.625	.557	1.700	2.863	.526	1.679	2.832	3.985	5.138	6.291	8.597	10.903	13.209	17.821	1.153	.040
100	1 1/8	1 1/4	.750	.669	2.077	3.484	.633	2.041	3.449	4.857	6.265	7.673	10.489	13.305	16.121	21.753	1.408	.046
120	1 1/4	1 1/2	.875	.894	2.683	4.472	.848	2.637	4.426	6.215	8.004	9.793	13.371	16.949	20.527	27.166	1.789	.057
140	1 1/2	1 3/4	1.000	.924	3.218	5.424	.894	2.772	4.696	6.620	8.544	10.468	14.316	18.164	22.012	29.824	1.924	.057
160	2	2 1/4	1.125	1.119	3.424	5.729	1.063	3.368	5.673	7.978	10.283	12.588	17.198	21.808	26.418	34.230	2.305	.062
180	2 1/2	2 3/4	1.406	1.259	3.851	6.443	1.197	3.789	6.381	8.973	11.565	14.157	19.341	24.527	29.712	38.549	2.592	.068
200	3	3 1/4	1.562	1.344	4.161	6.978	1.278	4.095	6.912	9.729	12.546	15.363	20.997	26.181	31.372	40.201	2.817	.072
240	3 1/2	3 3/4	1.875	1.682	5.140	8.598	1.601	5.059	8.517	11.975	15.433	18.891	25.363	30.549	35.734	45.562	3.458	.087

STANDARD SERIES ROLLER CHAIN SPROCKETS

HEAVY SERIES CHAIN SPROCKETS

60H	7/50	.500	.469	.444	1.472	2.500	.418	1.446	2.474	3.502	4.530	5.558	7.614	10.288	13.962	18.636	24.270	30.902	.036
80H	1.000	.625	.625	.557	1.840	3.123	.526	1.809	3.092	4.375	5.568	6.941	9.507	12.833	16.166	21.800	28.434	36.068	-.040
100H	1.250	.750	.750	.669	2.208	3.747	.633	2.172	3.711	5.250	6.789	8.328	11.406	15.484	20.562	27.196	34.830	43.464	-.046
120H	1.500	1.000	.875	.894	2.818	4.742	.848	2.772	4.696	6.620	8.544	10.468	14.316	19.164	24.912	32.546	41.180	50.854	-.057
140H	1.750	1.000	1.000	.924	3.494	5.904	.848	2.903	4.958	7.013	9.068	11.123	15.233	20.343	26.453	33.563	42.227	51.901	-.057
160H	2.000	1.250	1.125	1.119	3.555	5.991	1.063	3.499	5.935	8.371	10.807	13.243	18.115	23.983	30.857	38.731	47.605	57.479	-.062
180H	2.250	1.406	1.406	1.259	3.982	6.705	1.197	3.920	6.643	9.366	12.089	14.812	20.258	26.626	33.999	42.373	51.747	61.121	-.068
200H	2.500	1.500	1.562	1.344	4.427	7.510	1.278	4.361	7.444	10.527	13.610	16.693	22.859	29.727	37.599	46.473	56.347	66.221	-.072

† = Not made in multiple strands.

Maximum Hub Dimensions



Recommended Max. Hub and Bore Sizes

AMERICAN STANDARD NO. 25

AMERICAN STANDARD NO. 25												STD. KEYWAY (Am. Std.) and SETSCREW			
No. of Teeth	Max. RPM	Max. Hub	Max. Bore	No. of Teeth	Max. RPM	Max. Hub	Max. Bore	No. of Teeth	Max. RPM	Max. Hub	Max. Bore	Diam. of Set-screw	Min. added to bore for adequate hub wall Steel Sprockets		
													Diameter of Shaft	Keyway Width x Depth	Set-screw over Key
6	555	3/4	16	6940	3/62	3/16	26	8645	1 49/64	1 1/4	3/16"	3/32" x 3/64"	7/16"	3/8"
7	1300	15/64	17	7290	1 1/64	3/8	27	8655	1 59/64	1 1/4	3/16"	3/32" x 3/64"	15/32"	3/8"
8	2080	3/16	18	7590	1 1/8	3/4	28	8650	1 15/16	1 1/4	3/16"	3/32" x 3/64"	15/32"	3/8"
9	2860	7/16	1/4	19	7840	1 1/32	13/16	29	8625	2 1/64	1 1/4	3/16"	3/32" x 3/64"	15/32"	3/8"
10	3610	1/2	1/4	20	8050	1 1/64	7/8	30	8580	2 3/32	1 1/2	3/16"	3/32" x 3/64"	15/32"	3/8"
11	4310	9/16	5/16	21	8230	1 1/8	7/8	31	8540	2 11/64	1 1/2	3/16"	3/32" x 3/64"	15/32"	3/8"
12	4960	41/64	3/8	22	8370	1 1/64	15/16	32	8465	2 1/4	1 1/2	3/16"	3/32" x 3/64"	15/32"	3/8"
13	5540	47/64	7/16	23	8480	1 1/32	1	35	8200	2 51/64	1 1/2	3/16"	3/32" x 3/64"	15/32"	3/8"
14	6070	13/16	9/16	24	8560	1 1/64	1 1/16	40	7580	2 57/64	1 1/2	3/16"	3/32" x 3/64"	15/32"	3/8"
15	6530	57/64	9/16	25	8610	1 11/16	1 1/8	45	6820	3 3/32	2 1/4	3/16"	3/32" x 3/64"	15/32"	3/8"

AMERICAN STANDARD NO. 35

AMERICAN STANDARD NO. 35												STD. KEYWAY (Am. Std.) and SETSCREW			
No. of Teeth	Max. RPM	Max. Hub	Max. Bore	No. of Teeth	Max. RPM	Max. Hub	Max. Bore	No. of Teeth	Max. RPM	Max. Hub	Max. Bore	Diam. of Set-screw	Min. added to bore for adequate hub wall Steel Sprockets		
													Diameter of Shaft	Keyway Width x Depth	Set-screw over Key
6	290	15/64	16	3630	1 15/32	1 5/16	26	4525	2 63/64	1 3/4	3/16"	3/32" x 3/64"	15/32"	3/8"
7	680	3/8	17	3810	1 19/32	1 1/2	27	4530	2 61/64	1 3/4	3/16"	3/32" x 3/64"	15/32"	3/8"
8	1090	1/2	1/4	18	3970	1 23/32	1 1/2	28	4525	2 59/64	1 3/4	3/16"	3/32" x 3/64"	15/32"	3/8"
9	1495	5/8	3/8	19	4100	1 27/32	1 1/2	29	4510	3 1/32	2	3/16"	3/32" x 3/64"	15/32"	3/8"
10	1885	3/4	1/2	20	4210	1 61/64	1 1/2	30	4490	3 5/32	2 1/2	3/16"	3/32" x 3/64"	15/32"	3/8"
11	2260	55/64	5/8	21	4300	2 3/64	1 1/2	31	4470	3 3/32	2 1/2	3/16"	3/32" x 3/64"	15/32"	3/8"
12	2590	63/64	9/16	22	4380	2 1/4	1 1/2	32	4430	3 3/32	2 1/2	3/16"	3/32" x 3/64"	15/32"	3/8"
13	2900	1 1/64	1 1/8	23	4430	2 1/2	1 1/2	35	4290	3 3/4	2 1/2	3/16"	3/32" x 3/64"	15/32"	3/8"
14	3170	1 1/64	1 1/8	24	4480	2 1/2	1 1/2	40	3970	4 3/64	2 1/2	3/16"	3/32" x 3/64"	15/32"	3/8"
15	3420	1 29/64	1 1/8	25	4510	2 3/4	1 3/4	45	3570	4 67/64	3 1/4	3/16"	3/32" x 3/64"	15/32"	3/8"

AMERICAN STANDARD NO. 41

AMERICAN STANDARD NO. 41												STD. KEYWAY (Am. Std.) and SETSCREW			
No. of Teeth	Max. RPM	Max. Hub	Max. Bore	No. of Teeth	Max. RPM	Max. Hub	Max. Bore	No. of Teeth	Max. RPM	Max. Hub	Max. Bore	Diam. of Set-screw	Min. added to bore for adequate hub wall Steel Sprockets		
													Diameter of Shaft	Keyway Width x Depth	Set-screw over Key
6	130	27/64	16	1630	2 1/16	1 3/16	26	2040	3 43/64	2 3/8	3/16"	3/32" x 3/64"	1 1/2"	1 1/2"
7	305	19/32	5/16	17	1720	2 15/64	1 1/2	27	2040	3 39/64	2 3/8	3/16"	3/32" x 3/64"	1 1/2"	1 1/2"
8	495	49/64	1/2	18	1790	2 25/64	1 1/2	28	2040	4	2 3/4	3/16"	3/32" x 3/64"	1 1/2"	1 1/2"
9	675	15/16	9/16	19	1850	2 35/64	1 3/4	29	2040	4 5/32	2 3/4	3/16"	3/32" x 3/64"	1 1/2"	1 1/2"
10	850	1 15/32	1 1/8	20	1890	2 29/32	1 3/4	30	2020	4 1/2	2 3/4	3/16"	3/32" x 3/64"	1 1/2"	1 1/2"
11	1020	1 11/64	7/8	21	1940	2 1/8	1 3/4	31	2020	4 15/32	2 1/2	3/16"	3/32" x 3/64"	1 1/2"	1 1/2"
12	1170	1 29/64	7/8	22	1970	3 1/32	2	32	2000	4 11/64	3 1/8	3/16"	3/32" x 3/64"	1 1/2"	1 1/2"
13	1310	1 39/64	1 1/8	23	2000	3 3/16	2 1/8	35	1930	5 1/64	3 3/8	3/16"	3/32" x 3/64"	1 1/2"	1 1/2"
14	1430	1 1/4	1 1/4	24	2020	3 23/64	2 1/4	40	1780	5 29/64	3 3/8	3/16"	3/32" x 3/64"	1 1/2"	1 1/2"
15	1540	1 29/32	1 1/4	25	2030	3 39/64	2 1/4	45	1600	6 59/64	4 1/8	3/16"	3/32" x 3/64"	1 1/2"	1 1/2"

AMERICAN STANDARD NO. 40

AMERICAN STANDARD NO. 40												STD. KEYWAY (Am. Std.) and SETSCREW			
No. of Teeth	Max. RPM	Max. Hub	Max. Bore	No. of Teeth	Max. RPM	Max. Hub	Max. Bore	No. of Teeth	Max. RPM	Max. Hub	Max. Bore	Diam. of Set-screw	Min. added to bore for adequate hub wall Steel Sprockets		
													Diameter of Shaft	Keyway Width x Depth	Set-screw over Key
6	220	2 1/64	16	2720	1 63/64	1 1/4	26	3400	3 37/64	2 3/8	3/16"	3/32" x 3/64"	1 1/2"	1 1/2"
7	510	1/2	3/4	17	2860	2 1/4	1 1/2	27	3405	3 31/64	2 3/8	3/16"	3/32" x 3/64"	1 1/2"	1 1/2"
8	820	49/64	3/8	18	2980	2 15/64	1 1/2	28	3405	3 29/64	2 3/8	3/16"	3/32" x 3/64"	1 1/2"	1 1/2"
9	1125	27/32	9/16	19	3080	2 25/64	1 1/2	29	3395	4 1/16	2 3/4	3/16"	3/32" x 3/64"	1 1/2"	1 1/2"
10	1420	1 1/64	1 1/8	20	3160	2 3/8	1 1/2	30	3370	4 1/8	2 3/4	3/16"	3/32" x 3/64"	1 1/2"	1 1/2"
11	1690	1 11/64	3/4	21	3230	2 29/32	1 3/4	31	3360	4 3/8	2 3/4	3/16"	3/32" x 3/64"	1 1/2"	1 1/2"
12	1940	1 29/64	7/8	22	3290	2 15/16	1 3/4	32	3330	4 3/64	3	3/16"	3/32" x 3/64"	1 1/2"	1 1/2"
13	2180	1 1/2	1	23	3330	3 3/32	2 1/8	35	3220	5 1/8	3 3/4	3/16"	3/32" x 3/64"	1 1/2"	1 1/2"
14	2380	1 29/32	1 1/4	24	3360	3 1/64	2 1/4	40	2970	5 31/64	3 3/8	3/16"	3/32" x 3/64"	1 1/2"	1 1/2"
15	2560	1 15/16	1 1/4	25	3380	3 29/64	2 1/4	45	2670	6 39/64	4 1/8	3/16"	3/32" x 3/64"	1 1/2"	1 1/2"

AMERICAN STANDARD NO. 50

AMERICAN STANDARD NO. 50												STD. KEYWAY (Am. Std.) and SETSCREW			
No. of Teeth	Max. RPM	Max. Hub	Max. Bore	No. of Teeth	Max. RPM	Max. Hub	Max. Bore	No. of Teeth	Max. RPM	Max. Hub	Max. Bore	Diam. of Set-screw	Min. added to bore for adequate hub wall Steel Sprockets		
													Diameter of Shaft	Keyway Width x Depth	Set-screw over Key
6	155	27/64	1/8	16	1960	2 31/64	1 11/16	26	2445	4 31/64	2 15/8	3/16"	3/32" x 3/64"	1 1/2"	1 1/2"
7	370	41/64	3/8	17	2060	2 11/16	1 3/4	27	2450	4 11/16	2 15/8	3/16"	3/32" x 3/64"	1 1/2"	1 1/2"
8	590	27/32	9/16	18	2150	2 57/64	1 1/2	28	2445	4 57/64	3 1/4	3/16"	3/32" x 3/64"	1 1/2"	1 1/2"
9	810	1 1/16	1 1/8	19	2220	3 1/4	2 1/8	29	2440	5 1/64	3 1/2	3/16"	3/32" x 3/64"	1 1/2"	1 1/2"
10	1020	1 15/64	1 1/4	20	2280	3 3/32	2 1/4	30	2430	5 5/32	3 1/2	3/16"	3/32" x 3/64"	1 1/2"	1 1/2"
11	1220	1 35/64	1 1/2	21	2330	3 31/64	2 1/4	31	2415	5 31/64	3 1/2	3/16"	3/32" x 3/64"	1 1/2"	1 1/2"
12	1400	1 39/64	1 1/2	22	2370	3 11/16	2 1/2	32	2395	5 11/16	3 3/4	3/16"	3/32" x 3/64"	1 1/2"	1 1/2"
13	1570	1 1/8	1 1/4	23	2400	3 3/4	2 1/2	35	2320	6 3/32	4 1/8	3/16"	3/32" x 3/64"	1 1/2"	1 1/2"
14	1720	2 5/64	1 3/8	24	2420	4 1/64	2 3/4	40	2140	7 3/32	5 1/2	3/16"	3/32" x 3/64"	1 1/2"	1 1/2"
15	1850	2 3/32	1 1/2	25	2440	4 5/32	2 3/4	45	1930	8 3/32	6 1/4	3/16"	3/32" x 3/64"	1 1/2"	1 1/2"

AMERICAN STANDARD NO. 60

AMERICAN STANDARD NO. 60												STD. KEYWAY (Am. Std.) and SETSCREW			
No. of Teeth	Max. RPM	Max. Hub	Max. Bore	No. of Teeth	Max. RPM	Max. Hub	Max. Bore	No. of Teeth	Max. RPM	Max. Hub	Max. Bore	Diam. of Set-screw	Min. added to bore for adequate hub wall Steel Sprockets		
													Diameter of Shaft	Keyway Width x Depth	Set-screw over Key
6	120	33/64	1/4	16	1480	2 31/64	1 15/16	26	1840	5 59/64	3 3/8	3/16"	3/32" x 3/64"	1 1/2"	1 1/2"
7	275	49/64	1/2	17	1550	3 1/32	2 1/8	27	1845	5 3/8	3 3/4	3/16"	3/32" x 3/64"	1 1/2"	1 1/2"
8	445	1 1/32	5/8	18	1610	3 15/32	2 1/4	28	1840	5 7/8	3 3/8	3/16"	3/32" x 3/64"	1 1/2"	1 1/2"
9	610	1 15/32	7/8	19	1670	3 5/64	2 1/2	29	1835	6 1/64	4 1/8	3/16"	3/32" x 3/64"	1 1/2"	1 1/2"
10	770	1 39/64	1 1/4	20	1720	3 61/64	2 1/2	30	1830	6 11/32	4 1/8	3/16"	3/32" x 3/64"	1 1/2"	1 1/2"
11	920	1 49/64	1 1/2	21	1750	4 1/16	2 3/4	31	1815	6 19/32	4 1/8	3/16"	3/32" x 3/64"	1 1/2"	1 1/2"
12	1050	2 1/64	1 1/2	22	1780	4 1/8	2 3/4	32	1800	6 39/64	5 1/8	3/16"	3/32" x 3/64"	1 1/2"	1 1/2"
13	1180	2 1/4	1 1/2	23	1800	4 3/64	2 3/4	35	1740	7 35/64	5 1/2	3/16"	3/32" x 3/64"	1 1/2"	1 1/2"
14	1290	2 1/2	1 3/4	24	1820	4 29/64	3 1/4	40	1610	8 1/4	6 1/2	3/16"	3/32" x 3/64"	1 1/2"	1 1/2"
15	1390	2 3/4	1 3/4	25	1830	5 3/32	3 3/8	45	1450	9 15/16	7 1/8	3/16"	3/32" x 3/64"	1 1/2"	1 1/2"



Maximum Hub Dimensions

Recommended Max. Hub and Bore Sizes

AMERICAN STANDARD NO. 80

AMERICAN STANDARD NO. 80												STD. KEYWAY (Am. Std.) and SETSCREW			
No. of Teeth	Max. RPM	Max. Hub	Max. Bore	No. of Teeth	Max. RPM	Max. Hub	Max. Bore	No. of Teeth	Max. RPM	Max. Hub	Max. Bore	Diam. of Set-screw	Min. added to bore for adequate hub wall Steel Sprockets		
													Diameter of Shaft	Keyway Width x Depth	Setscrew over Key
6	75	⁵ / ₁₆	⁷ / ₁₆	16	935	3 ⁵ / ₁₆	2 ¹ / ₁₆	26	1165	7 ³ / ₁₆	5 ⁷ / ₁₆				
7	175	1 ¹ / ₁₆	⁹ / ₁₆	17	985	4 ¹ / ₁₆	2 ¹ / ₁₆	27	1170	6 ³ / ₁₆	5 ¹ / ₂				
8	280	1 ³ / ₁₆	⁷ / ₈	18	1020	4 ³ / ₁₆	3 ¹ / ₂	28	1170	7 ² / ₁₆	5 ¹ / ₂				
9	385	1 ⁵ / ₁₆	1 ¹ / ₁₆	19	1060	4 ⁵ / ₁₆	3 ³ / ₄	29	1165	8 ³ / ₁₆	6 ¹ / ₂				
10	485	2 ¹ / ₁₆	1 ¹ / ₂	20	1090	5 ¹ / ₁₆	3 ¹ / ₂	30	1160	8 ⁵ / ₁₆	6 ¹ / ₂				
11	580	2 ³ / ₁₆	1 ⁵ / ₈	21	1110	5 ³ / ₁₆	3 ³ / ₄	31	1155	8 ⁷ / ₁₆	6 ¹ / ₂				
12	670	2 ⁵ / ₁₆	1 ⁷ / ₈	22	1130	5 ⁵ / ₁₆	3 ⁷ / ₈	32	1143	9 ¹ / ₁₆	6 ¹ / ₂				
13	750	3 ¹ / ₁₆	2	23	1150	6 ¹ / ₁₆	4 ¹ / ₁₆	35	1110	10 ¹ / ₁₆	7 ¹ / ₂				
14	820	3 ³ / ₁₆	2 ¹ / ₁₆	24	1160	6 ³ / ₁₆	4 ³ / ₁₆	40	1020	11 ¹ / ₁₆	8 ¹ / ₂				
15	880	3 ⁵ / ₁₆	2 ³ / ₁₆	25	1160	6 ⁵ / ₁₆	5 ¹ / ₁₆	45	920	13 ¹ / ₁₆	9 ¹ / ₂				

AMERICAN STANDARD NO. 100

AMERICAN STANDARD NO. 100												STD. KEYWAY (Am. Std.) and SETSCREW			
No. of Teeth	Max. RPM	Max. Hub	Max. Bore	No. of Teeth	Max. RPM	Max. Hub	Max. Bore	No. of Teeth	Max. RPM	Max. Hub	Max. Bore	Diam. of Set-screw	Min. added to bore for adequate hub wall Steel Sprockets		
													Diameter of Shaft	Keyway Width x Depth	Setscrew over Key
6	55	¹ / ₂	⁹ / ₁₆	16	670	5	3 ¹ / ₄	26	830	9 ¹ / ₁₆	6 ¹ / ₂				
7	125	1 ¹ / ₁₆	³ / ₄	17	700	5 ¹ / ₁₆	3 ³ / ₄	27	835	9 ¹ / ₁₆	6 ¹ / ₂				
8	200	1 ³ / ₁₆	1 ¹ / ₁₆	18	730	5 ³ / ₁₆	3 ³ / ₄	28	830	9 ¹ / ₁₆	6 ¹ / ₂				
9	275	2 ¹ / ₁₆	1 ³ / ₁₆	19	755	6 ¹ / ₁₆	4 ¹ / ₁₆	29	830	10 ¹ / ₁₆	7 ¹ / ₂				
10	350	2 ³ / ₁₆	1 ⁵ / ₁₆	20	775	6 ³ / ₁₆	4 ¹ / ₁₆	30	825	10 ³ / ₁₆	7 ¹ / ₂				
11	415	2 ⁵ / ₁₆	1 ⁷ / ₁₆	21	790	7	5 ¹ / ₄	31	820	11	8				
12	475	3 ¹ / ₁₆	2 ¹ / ₁₆	22	805	7 ¹ / ₁₆	5 ¹ / ₄	32	815	11 ¹ / ₁₆	8 ¹ / ₂				
13	535	3 ³ / ₁₆	2 ³ / ₁₆	23	815	7 ³ / ₁₆	5 ³ / ₈	35	790	12 ¹ / ₁₆	9 ¹ / ₂				
14	585	4 ¹ / ₁₆	2 ⁵ / ₁₆	24	825	8 ¹ / ₁₆	6 ¹ / ₁₆	40	730	14 ¹ / ₁₆	10 ¹ / ₂				
15	630	4 ³ / ₁₆	3 ¹ / ₁₆	25	830	8 ³ / ₁₆	6 ¹ / ₂	45	655	16 ¹ / ₁₆	11 ¹ / ₂				

AMERICAN STANDARD NO. 120

AMERICAN STANDARD NO. 120												STD. KEYWAY (Am. Std.) and SETSCREW			
No. of Teeth	Max. RPM	Max. Hub	Max. Bore	No. of Teeth	Max. RPM	Max. Hub	Max. Bore	No. of Teeth	Max. RPM	Max. Hub	Max. Bore	Diam. of Set-screw	Min. added to bore for adequate hub wall Steel Sprockets		
													Diameter of Shaft	Keyway Width x Depth	Setscrew over Key
6	40	1 ¹ / ₁₆	¹ / ₂	16	520	6	4	26	650	10 ¹ / ₁₆	7 ¹ / ₁₆				
7	100	1 ³ / ₁₆	1 ¹ / ₁₆	17	550	6 ³ / ₁₆	4 ¹ / ₁₆	27	650	11 ¹ / ₁₆	8 ¹ / ₄				
8	155	2 ¹ / ₁₆	1 ³ / ₁₆	18	570	6 ⁵ / ₁₆	5 ¹ / ₁₆	28	650	11 ³ / ₁₆	8 ¹ / ₂				
9	215	2 ³ / ₁₆	1 ⁵ / ₁₆	19	590	7 ¹ / ₁₆	5 ¹ / ₂	29	650	12 ¹ / ₁₆	8 ¹ / ₂				
10	270	3 ¹ / ₁₆	2 ¹ / ₁₆	20	605	7 ³ / ₁₆	5 ³ / ₈	30	645	12 ³ / ₁₆	9 ¹ / ₂				
11	325	3 ³ / ₁₆	2 ³ / ₁₆	21	620	8 ¹ / ₁₆	6 ¹ / ₁₆	31	645	13 ¹ / ₁₆	9 ¹ / ₂				
12	375	4 ¹ / ₁₆	2 ⁵ / ₁₆	22	630	8 ³ / ₁₆	6 ³ / ₁₆	32	640	13 ³ / ₁₆	10 ¹ / ₂				
13	415	4 ³ / ₁₆	3	23	640	9 ¹ / ₁₆	6 ⁵ / ₁₆	35	615	15 ¹ / ₁₆	10 ¹ / ₂				
14	455	5 ¹ / ₁₆	3 ¹ / ₄	24	645	9 ³ / ₁₆	7 ¹ / ₁₆	40	570	17 ¹ / ₁₆	11 ¹ / ₂				
15	490	5 ³ / ₁₆	3 ³ / ₁₆	25	650	10 ¹ / ₁₆	7 ¹ / ₂	45	515	19 ¹ / ₁₆	12 ¹ / ₂				

AMERICAN STANDARD NO. 140

AMERICAN STANDARD NO. 140												STD. KEYWAY (Am. Std.) and SETSCREW			
No. of Teeth	Max. RPM	Max. Hub	Max. Bore	No. of Teeth	Max. RPM	Max. Hub	Max. Bore	No. of Teeth	Max. RPM	Max. Hub	Max. Bore	Diam. of Set-screw	Min. added to bore for adequate hub wall Steel Sprockets		
													Diameter of Shaft	Keyway Width x Depth	Setscrew over Key
6	30	1 ¹ / ₄	³ / ₈	16	380	7 ¹ / ₁₆	5 ¹ / ₄	26	475	12 ¹ / ₁₆	9 ¹ / ₂				
7	70	1 ³ / ₁₆	1 ¹ / ₄	17	400	7 ³ / ₁₆	5 ³ / ₈	27	475	13 ¹ / ₁₆	9 ¹ / ₂				
8	115	2 ¹ / ₁₆	1 ³ / ₁₆	18	415	8 ¹ / ₁₆	6 ¹ / ₁₆	28	475	13 ³ / ₁₆	10 ¹ / ₄				
9	150	3 ¹ / ₁₆	2	19	430	8 ³ / ₁₆	6 ³ / ₁₆	29	475	14 ¹ / ₁₆	10 ¹ / ₄				
10	200	3 ³ / ₁₆	2 ¹ / ₁₆	20	440	9 ¹ / ₁₆	6 ³ / ₄	30	470	14 ³ / ₁₆	10 ¹ / ₄				
11	235	4 ¹ / ₁₆	2 ³ / ₁₆	21	450	9 ³ / ₁₆	7 ¹ / ₁₆	31	470	15 ¹ / ₁₆	10 ¹ / ₄				
12	270	4 ³ / ₁₆	3 ¹ / ₄	22	460	10 ¹ / ₁₆	7 ¹ / ₂	32	465	15 ³ / ₁₆	10 ¹ / ₄				
13	305	5 ¹ / ₁₆	3 ³ / ₁₆	23	465	10 ³ / ₁₆	7 ³ / ₁₆	35	450	17 ¹ / ₁₆	10 ¹ / ₄				
14	335	5 ³ / ₁₆	3 ⁵ / ₁₆	24	470	11 ¹ / ₁₆	8 ¹ / ₂	40	415	20 ¹ / ₁₆	11 ¹ / ₄				
15	360	6 ¹ / ₁₆	4 ¹ / ₁₆	25	475	12 ¹ / ₁₆	8 ³ / ₁₆	45	375	23 ¹ / ₁₆	12 ¹ / ₄				

AMERICAN STANDARD NO. 160

AMERICAN STANDARD NO. 160												STD. KEYWAY (Am. Std.) and SETSCREW			
No. of Teeth	Max. RPM	Max. Hub	Max. Bore	No. of Teeth	Max. RPM	Max. Hub	Max. Bore	No. of Teeth	Max. RPM	Max. Hub	Max. Bore	Diam. of Set-screw	Min. added to bore for adequate hub wall Steel Sprockets		
													Diameter of Shaft	Keyway Width x Depth	Setscrew over Key
6	25	1 ⁵ / ₁₆	³ / ₈	16	325	8 ¹ / ₁₆	6	26	405	14 ¹ / ₁₆	10 ¹ / ₁₆				
7	60	2 ¹ / ₁₆	1 ¹ / ₂	17	340	8 ³ / ₁₆	6 ¹ / ₂	27	405	15 ¹ / ₁₆	10 ¹ / ₁₆				
8	100	2 ³ / ₁₆	1 ³ / ₁₆	18	355	9 ¹ / ₁₆	6 ³ / ₁₆	28	405	15 ³ / ₁₆	10 ¹ / ₁₆				
9	135	3 ¹ / ₁₆	2 ¹ / ₁₆	19	365	9 ³ / ₁₆	7 ¹ / ₁₆	29	400	16 ¹ / ₁₆	10 ¹ / ₁₆				
10	170	4 ¹ / ₁₆	2 ³ / ₁₆	20	375	10 ¹ / ₁₆	7 ³ / ₁₆	30	400	17	10 ¹ / ₁₆				
11	200	4 ³ / ₁₆	3 ¹ / ₄	21	385	11 ¹ / ₁₆	8 ¹ / ₁₆	31	400	17 ³ / ₁₆	10 ¹ / ₁₆				
12	230	5 ¹ / ₁₆	3 ³ / ₁₆	22	390	11 ³ / ₁₆	8 ³ / ₁₆	32	395	18 ¹ / ₁₆	10 ¹ / ₁₆				
13	260	6 ¹ / ₁₆	4 ¹ / ₁₆	23	395	12 ¹ / ₁₆	9	35	380	20 ¹ / ₁₆	10 ¹ / ₁₆				
14	280	6 ³ / ₁₆	4 ³ / ₁₆	24	400	13 ¹ / ₁₆	9 ¹ / ₁₆	40	355	23 ¹ / ₁₆	10 ¹ / ₁₆				
15	305	7 ¹ / ₁₆	5 ¹ / ₁₆	25	400	13 ³ / ₁₆	10 ¹ / ₁₆	45	320	26 ¹ / ₁₆	10 ¹ / ₁₆				

AMERICAN STANDARD NO. 200

AMERICAN STANDARD NO. 200												STD. KEYWAY (Am. Std.) and SETSCREW			
No. of Teeth	Max. RPM	Max. Hub	Max. Bore	No. of Teeth	Max. RPM	Max. Hub	Max. Bore	No. of Teeth	Max. RPM	Max. Hub	Max. Bore	Diam. of Set-screw	Min. added to bore for adequate hub wall Steel Sprockets		
													Diameter of Shaft	Keyway Width x Depth	Setscrew over Key
6	20	1 ³ / ₁₆	1 ¹ / ₄	16	235	10 ¹ / ₁₆	7 ¹ / ₂	26	290	18 ¹ / ₁₆	10 ¹ / ₁₆				
7	45	2 ¹ / ₁₆	1 ³ / ₄	17	245	10 ³ / ₁₆	7 ³ / ₁₆	27	290	18 ³ / ₁₆	10 ¹ / ₁₆				
8	70	3 ¹ / ₁₆	2 ¹ / ₄	18	255	11 ¹ / ₁₆	8 ¹ / ₁₆	28	290	19 ¹ / ₁₆	10 ¹ / ₁₆				
9	95	4 ¹ / ₁₆	2 ³ / ₁₆	19	265	12 ¹ / ₁₆	8 ³ / ₁₆	29	290	20 ¹ / ₁₆	10 ¹ / ₁₆				
10	120	5 ¹ / ₁₆	3 ¹ / ₄	20	270	13 ¹ / ₁₆	9 ¹ / ₁₆	30	290	21 ¹ / ₁₆	10 ¹ / ₁₆				
11	145	5 ³ / ₁₆	3 ³ / _{16</}												

Application Data and Selection Procedure

How to Check Horsepower Rating of Installed Drive

1. Determine the types of driving and driven loads and obtain the proper service factor, as explained in Steps 1 and 2 under Selection Procedures.
2. Find the multiple strand factor, for the number of chain strands in the drive, from the Multiple Strand Factor Table, in Horsepower Tables (Page E-186 thru E-192).
3. From the horsepower rating table for the chain pitch, read the figure under the RPM of the small sprocket and to the right of the column giving number of teeth in the small sprocket.
4. The horsepower this drive can properly transmit is as follows:

$$\text{HORSEPOWER DRIVE CAN TRANSMIT} = \frac{\left(\begin{array}{c} \text{Rating Table} \\ \text{Horsepower} \end{array} \right)}{\text{Service Factor}} \times \left(\begin{array}{c} \text{Multiple Strand} \\ \text{Factor} \end{array} \right)$$

Center Distance

The following general principals should be applied in determining shaft center distances. The center distance must always be greater than one-half the sum of the sprocket outside diameters to avoid interference of teeth. When the speed ratio is greater than 3 to 1, the center distance should be not less than the sum of the sprocket diameters. Chain wrap should be at least 120° of the small sprocket — one-third of the teeth meshing.

Longer center distances give greater chain wrap. For average applications a center distance of 30 to 50 pitches of chain is recommended for best results. For pulsating loads, a center distance of 20 to 30 pitches may be desirable. For center distances of 80 pitches or greater, idlers or chain guides should be used to support the chain. Slightly adjustable center distances will provide chain tension as the chain elongates with wear.

Alignment

Accurate alignment of shafts and sprocket tooth faces provide uniform distribution of the load across the entire chain width and contributes substantially to optimum drive life. Shafting, bearings, and foundations should be suitable to maintain the initial alignment. Periodic maintenance should include an inspection of alignment to insure optimum chain life.

Design Horsepower

When making drive selections consideration is given to the loads imposed on the chain. Service factors based on the type of equipment to be driven (Table I, Page E162) and the type of input power (Table II, Page E162) are used to compensate for these loads.

Horsepower Rating Tables

The horsepower ratings in this catalog apply to lubricated single pitch, single strand precision roller chains, both standard and double pitch roller chain.

The ratings reflect a service factor of 1, a chain length of approximately 100 pitches, use of recommended lubrication methods, and a drive arrangement where two aligned sprockets are mounted on parallel horizontal shafts.

The horsepower ratings relate to the speed of the smaller sprocket and drive selections are made on this basis, whether the drive is speed reducing or speed increasing.

For ratings of multiple strand roller chains refer to Multiple Strand Factor in Horsepower Tables.

Lubrication

It has been shown that a separate wedge of fluid lubricant is formed in operating chain joints much like that formed in journal bearings. Therefore, fluid lubricant must be applied to assure an oil supply to the joints and minimize metal to metal contact. Lubrication, if supplied in sufficient volume, also provides effective cooling and impact damping at the higher speeds. For this reason, it is important that the lubrication recommendations be followed. The horsepower rating tables shown throughout this catalog, apply only to drives lubricated in the manner specified in the tables.

Chain drives should be protected against dirt and moisture and the oil supply kept free of contamination. Periodic oil change is desirable. A good grade of non-detergent petroleum base oil is recommended. Heavy oils and grease are generally too stiff to enter and fill the chain joints.

Application Data and Selection Procedure

Types of Lubrication

There are four basic types of lubrication for chain drives. The recommended type shown in the horsepower rating tables is influenced by chain speed and the amount of power transmitted. These are minimum lubrication requirements and the use of a better type (for example, Type C instead of Type B) is acceptable and may be beneficial. Chain life can vary appreciably depending upon the way the drive is lubricated. The better the lubrication, the longer the chain and sprocket life. For this reason, it is important that the lubrication recommendations be followed when using the rating tables given in this catalog.

Lubrication

TYPE A — Manual Lubrication. Oil applied periodically with brush or spout can.

TYPE B — Oil Bath or Oil Slinger. Oil level maintained in casing at predetermined height.

TYPE C — Oil Stream. Oil supplied by circulating pump inside chain loop on lower span.

NOTE: Drip Lubrication. Oil applied between link plate edges from a drip lubricator and should be used in clean environments only.

Selection of Roller Chain Drives

The following information is necessary for the proper selection and design of Roller Chain Drives:

1. Type of input horsepower (electrical motor, internal combustion engine.)
2. Type of equipment to be driven.
3. Horsepower to be transmitted.
4. Full load speed of the fastest running shaft. (R.P.M.)
5. Desired speed of the slow speed shaft. (R.P.M.)
6. Diameters of the driving and driven shafts.
7. Center to center distance of shafts.
8. Position of drive and space limitations.
9. Method of lubrication.
10. Conditions of drive, steady or fluctuating load, hours of operation, lubrication.

Most roller chain drive applications allow considerable latitude in the selection of sprocket sizes and chain pitch, although usually one combination will best fulfill the requirements of power, speed, space limitations and economy.

Chain and Sprocket Selection Procedure Steps:

1. Determine class of driven load.
2. Select service factor.
3. Calculate design horsepower.
4. Select chain pitch.
5. Select number of teeth in small sprocket.
6. Determine number of teeth in larger sprocket.
7. Determine center distance.
8. Calculate chain length.

Drive Positions

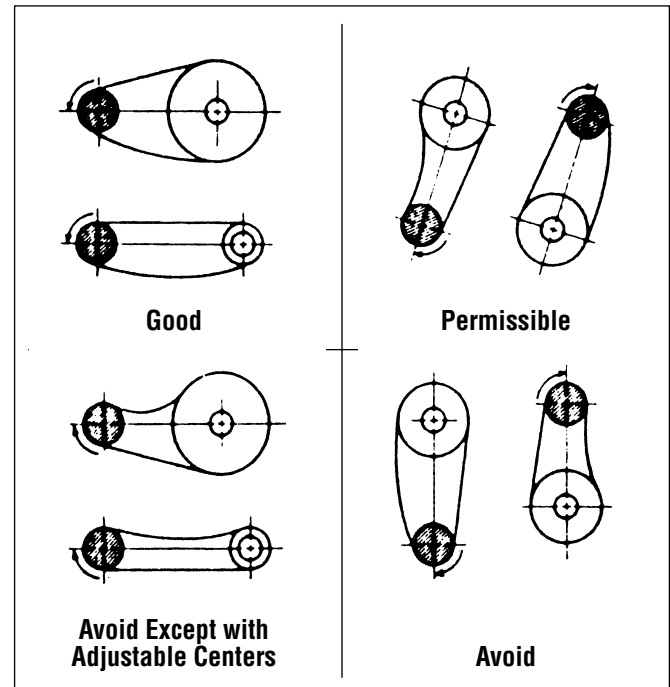

Application Data and Selection Procedure

Step I

Service Classification — Table I

Uniform Load

Agitators, Liquid	Generators
Blowers, Centrifugal	Line Shafts, Even Load
Conveyors, Even Load	Machines, Even Load,
Elevators, Even Load	Non-reversing
Fans, Centrifugal	Pumps, Centrifugal

Moderate Shock Load

Beaters	Laundry - Washers
Compressors, Centrifugal	and Tumblers
Conveyors, Uneven Load	Line Shafts, Uneven Load
Elevators, Uneven Load	Machines, Pulsating
Grinders, Pulp	Load, Non-reversing
Kilns and Dryers	Pumps, Reciprocating, Triplex
	Screens, Rotary, Even Load
	Woodworking Machinery

Heavy Shock Load

Brick Machines	Mills, Hammer, Rolling
Compressors Reciprocating	or Drawing
Crushers	Presses
Machines, Reversing or Impact Loads	Pumps, Reciprocating, Simplex or Duplex

Step III

Determination of Design Horsepower

Determine the design horsepower of the required drive using the following procedure.

1. Determine Service Classification — Table I. Unlisted equipment may be classified by its similarity to a listed type.
2. Using Service Classification and Frequency of Service, select the Service Factor — Table II. Increase the Service Factor by adding compensation for unfavorable operating conditions.
3. Multiply the normal operating horsepower of the drive by the Compensated Service Factor to obtain Service Horsepower.

Step IV

Drive Selection

Using Design Horsepower computed above, use Trial Selection Chart on page E184-E185, or enter tables of Horsepower Ratings shown on pages E184 thru E185. Select the smallest pitch chain which has the required horsepower rating for a pinion sprocket turning at the specified RPM. Check to be certain the selected sprocket has a listed maximum bore large enough to accommodate the specified shaft. The tables on pages E-158 thru E-159 gives maximum bores for the usual range of driving sprockets.

If the Design Horsepower at the required RPM is greater than the horsepower rating of the largest pitch chain which can operate at that speed, a multiple chain drive should be considered for the application.

Selection of drives to operate at speeds somewhat below the maximum rating will increase the life of the drive and quietness of operation.

Step II

Service Factor — Table II

SERVICE CLASSIFICATION	TYPE OF INPUT POWER		
	Internal Combustion Engine with Hydraulic Drive	Electric Motor or Turbine	Internal Combustion Engine with Mechanical Drive
Uniform Load	1.0	1.0	1.2
Moderate Shock Load	1.2	1.3	1.4
Heavy Shock Load	1.4	1.5	1.7

Unfavorable Operating Conditions which may be present should be compensated for by adding .2 to the Service Factor for each unfavorable condition. Some of these conditions are listed below:

1. Multiple Shafts — add .2 for each additional shaft.
2. Excessive speed ratios — exceeding 7 to 1.
3. Heavy starting loads with frequent starts and stops.
4. Conditions of high temperatures, unusually abrasive conditions, or circumstances decreasing lubrication effectiveness or not allowing the use of recommended lubrication procedures.

Step V

Driving Sprocket

In selecting the driving sprocket **17 teeth are recommended as a minimum** although 15 teeth are quite often used, and as low as 7 teeth can be cut. When the maximum bore of the 17 tooth sprocket will not accommodate the driving shaft, it is necessary to go to a sprocket with a greater number of teeth. Hardened teeth are recommended for sprockets with 25 teeth or less.

Application Data and Selection Procedure

Step VI

Driven Sprocket (Ratio)

The number of teeth selected for the driven sprocket depends upon the driving sprocket chosen and the desired speed of the driven shaft. When space limitations are a factor, the diameter of the driven sprocket sometimes determines the final selection of drive.

The recommended maximum speed ratio is 7 to 1, although higher ratios are occasionally used. It is usually better design, however, for large reductions to use a double reduction drive.

Select the driven sprocket size from the Speed Ratio Table on page E-170 using the required speed ratio and size of driver sprocket.

Step VII

Shaft Centers

May be calculated from the formula on page E-168 where the sprocket diameters and chain length are known.

On many applications the motor base is adjustable, allowing for slight changes in shaft centers. On long centers some form of chain adjuster or take-up is recommended.

Step VIII

Chain Length

On page E-168 is shown a simple method of computing the length of chain necessary for a drive with given sprocket dimensions and center to center distance of shafts. (See chart on page E-169 for length in ft.)

Chain Drive Design Example

To select a roller chain drive from a 10 HP electric motor (1½" shaft) 1200 RPM (1150 under load) to a wood working machine shaft at 300 RPM on 30" centers. Drive conditions — moderate pulsating load, good lubrication, 10 hour day operation.

1. Service class — moderate shock load (Table I).
2. Service factor — 1.3 (Table II).
3. Design HP — $1.3 \times 10 = 13$ DHP.
4. Selection — The Horsepower Ratings on page E-184 show that either of the following combinations may be used.

No. D40-19 Tooth — Smoothest in operation

No. 50-18 Tooth — Lower drive cost

For our purpose we select No. 50 chain and checking the bore find that the 1½" shaft can be accommodated with a stock bored to size sprocket.

The driven sprocket is found as follows:

No. Teeth

Driven

$$\text{Sprocket} = 18 \times \frac{1150}{300} (\text{Ratio}) = 68.99 \text{ or } 69 \text{ Teeth}$$

Since 69 teeth is not a stock size we select 70 teeth. The chain length is calculated as shown on page E-169 and is 142 pitches.

Overhung Load

When a Sprocket is mounted on a reducer shaft, a calculation should be made to determine the overhung load in pounds using formula on page L-2 in general engineering section.

Engineering Data & Design

Horsepower — equals 33,000 foot pounds per minute, or 550 foot pounds per second. In terms of chain load and speed.

$$HP = \frac{\text{Working Load} \times \text{Ft. Per Min.}}{33,000}$$

$$\text{or } HP = \frac{\text{Working Load} \times T \times P \times \text{R.P.M.}}{396,000}$$

Where T = number of sprocket teeth
P = chain pitch

Chain Working Load — when the horsepower input is known and the chain working load is desired, this can be calculated as follows:

$$\text{Working Load} = \frac{HP \times 33,000}{\text{Ft. Per Min.}}$$

$$\text{or } = \frac{HP \times 396,000}{T \times P \times \text{R.P.M.}}$$

Chain Speed — can be determined from the following formula:

$$\text{Chain Speed (Ft. Per Min.)} = \frac{T \times \text{R.P.M.}}{K}$$

where T = number of sprocket teeth
Constant K (Pitches of Chain Per Foot)

PITCH	5/8"	1/2"	3/8"	3/4"	1"	1 1/4"	1 1/2"	1 3/4"	2"	2 1/2"	3"
K	32	24	19.2	16	12	9.6	8	6.85	6	4.8	4

Approx. Wt./Ft. of Standard Roller Chain

Number	Single	Double	Triple	Quadruple
25	.08	.18	.27	.35
35	.23	.46	.69	.92
41	.28	—	—	—
40	.41	.82	1.23	1.64
50	.69	1.38	2.07	2.76
60	1.04	2.08	3.12	4.16
80	1.77	3.54	5.31	7.08
100	2.59	5.18	7.77	10.36
120	4.05	8.10	12.15	16.20
140	5.10	10.20	15.30	20.40
160	6.85	13.70	20.55	27.40
180	9.30	18.20	27.20	36.30
200	10.20	21.00	31.50	42.00
240	16.90	33.40	50.00	66.50

Factor of Safety — is determined as follows:

$$F.S. = \frac{\text{Chain Ultimate Strength}}{\text{Chain Working Load}}$$

Shaft Torque — Ordinarily is greater for the driven shaft than for the driving shaft due to the difference in sprocket sizes and R.P.M. Torque is usually expressed in inch pounds.

$$\text{Torque (Driving Shaft)} = \frac{HP \times 63,000}{\text{R.P.M.}}$$

$$\text{Torque (Driven Shaft)} = \text{Working Load} \times R$$

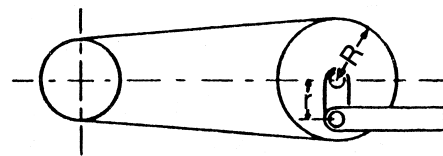

Where a crank arm is used the load transmitted by the arm can be determined as follows:

$$\text{Crank arm Load} = \frac{\text{Driven Shaft Torque}}{r}$$

$$\text{or } = \frac{\text{Chain Working Load} \times R}{r}$$

Catenary Tension — imposed by reason of the weight of chain can be approximated as follows:

$$\text{Catenary Tension} = \frac{W \times L^2}{8 \times S} + (W \times S)$$

where W = weight of chain (lbs. per ft.)

S = chain sag (feet) = 2% to 3% of shaft centers approx.

L = Shaft centers in feet.

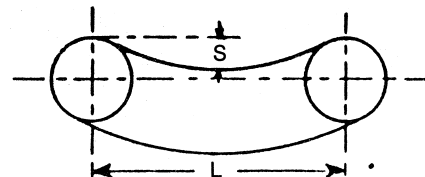

Engineering Data & Design

Conveyor Chains

Chains used in the design of conveyors should be selected on the basis of the **chain pull** imposed by the application and the permissible or **maximum working load** of the chain.

In some instances a larger pitch chain than is necessary may be selected due to the desired attachment spacing, and the effect in this case would be to increase the life of the conveyor.

HORIZONTAL CONVEYORS

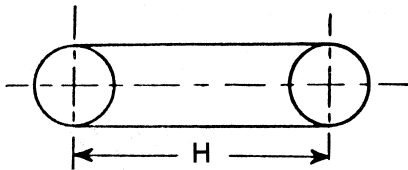

$$\text{Total pull of chains} = f H (W + P)$$

NOTE: When lower strand of conveyor drags on runway above formula becomes $f H (W + 2P)$.

VERTICAL CONVEYORS

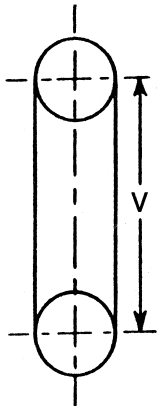

$$\text{Total pull of chains} = V (W + P)$$

- H (feet) = Horizontal projection of conveyor length.
- V (feet) = Vertical projection of conveyor length.
- W (pounds) = Weight of material handled per foot of conveyor length.
- P (pounds) = Weight per foot of all moving conveyor parts (single or two strand).
- f = Coefficient of friction of chain on runway.

Chain Pull

The force or pull required to move a conveyor includes the pull necessary to move the weight of chain and material and the frictional resistance of the chain parts on the runways. The following formulas may be used in calculating the total chain pull. The same formula applies in the case of single or parallel strand chain conveyors, but in the case of parallel strand conveyors, the pull per chain is one-half of the figure calculated from the formula.

INCLINED CONVEYORS

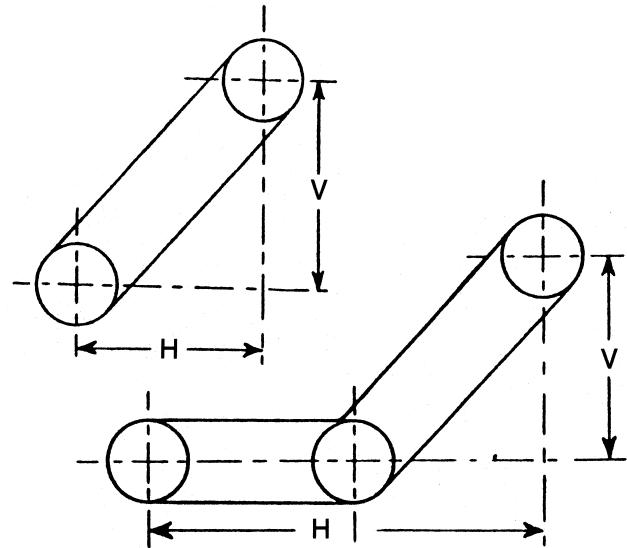

$$\text{Total pull of chains} = f H (W + P) + V (W + P)$$

NOTE: When lower strand of conveyor drags on runway the factor P ($f H - V$) should be added to above formula unless V is greater than f H.

Value of Coefficient F

Sliding steel on iron or steel	25%
Rolling friction	15%

(If material or other than the usual chain parts are in contact with the runway, the coefficient should be increased to compensate for the added resistance.)

Chain Drive Selection

Step 1:

Prime Driver:	_____	_____	_____
	Type & Description	Rated - H.P.	R.P.M.
Driven Comp:	_____	_____	_____
	Type & Description	R.P.M.	Hours/Day
Center Distance:	_____ "	_____ "	_____ "
	Maximum	Minimum	Nominal

Step 2: _____
 Service Classification (Step I Page E-162)

Step 3: _____ (Include additions to basic factor)
 Service Factor (Step II Page E-162)

Step 4: Determine Design H.P. _____ × _____ = _____
 H.P. Service Factor H.P. Design

Step 5: Speed Ratio _____ ÷ _____ = _____
 RPM Faster Shaft RPM Slower Shaft Ratio (E-172)

Step 6: From selector chart, select proper chain pitch & driver sprocket.
 (check *Martin* Catalog page E-184)

A. _____ B. _____
 Chain Pitch Driver Sprocket
 Maximum Bore
 (Pages E-16 thru E-112)

Step 7: From ratio chart, select proper driven sprocket.

C. _____
 Driven Sprocket Maximum Bore

Step 8: Check manufacturer's catalog for maximum bore recommended & final stock selection. (Pages E-16 thru E-112)

Step 9: Review Horsepower table for type of lubrication required.

OR TYPE: A B C (Pages E-161 and E-186 thru E-192)
 TYPE: 1 2 3 (Pages E-191 and E-192)

Step 10: _____ ÷ _____ = _____
 Center Dist. (inches) Chain Pitch Center Dist. (pitches)

Step 11: Formula for chain length = $2C + \frac{N+n}{2} + \frac{A}{C}$

Where:

- C = Center Dist. in pitches
- N = Number of teeth in Driven Sprocket
- n = Number of teeth in Driver Sprocket
- A = Value from table tabulated for N - n values

Brinell, Rockwell and Scleroscope Hardness Numbers with Corresponding Tensile Strength

Brinell 10 MM Ball 3,000 Kg.	Rockwell "C" 120 Cone 150 Kg.	Scleroscope Shore Model C	Tensile Strength 1000 Lb. Per Sq. In.
745	68	100	368
712	66	95	352
682	64	91	337
653	62	87	324
627	60	84	311
601	58	81	298
578	57	78	287
555	55	75	276
534	53	72	266
514	52	70	256
495	50	67	247
477	49	65	238
461	47	63	229
444	46	61	220
429	45	59	212
415	44	57	204
401	42	55	196
388	41	54	189
375	40	52	182
362	38	51	176
351	37	49	170
341	36	48	165
331	35	46	160
321	34	45	155
311	33	44	150
302	32	43	146
293	31	42	142
285	30	40	138
277	29	39	134
269	28	38	131
262	26	37	128
255	25	37	125
248	24	36	122
241	23	35	119
235	22	34	116
229	21	33	113
223	20	32	110
	Rockwell "B" 1/16" Ball 100 Kg.		
217	97	31	107
212	96	31	104
207	95	30	101
202	94	30	99
197	93	29	97
192	92	28	95
187	91	28	93
183	90	27	91
179	89	27	89
174	88	26	87

Note: Hardening cannot be accurately checked with a file — stationary or portable hardness testers should be used for conclusive results.

Material

All *Martin* stock sprockets are made of quality steel poured to our specifications.

Bar size sprockets normally include sizes up to 7" or 7½" in diameter type "B", "BS", "QD", "TB" single, double & triple width. And can easily be electrical induction or flame hardened — to Rockwell "C" 40 to 50.

Plate sprockets normally include sizes 7½" in diameter and larger type "B", "BS", "C", "QD", "TB" single, double, & triple width fabricated and type "A" all diameters. This material would have 35 to 40 points of carbon and can be induction or flame hardened to Rockwell "C" 30 to 45. Degree of hardness obtainable and method depends on size of sprocket.

Special quality steel can be used for large quantities or made-to-order sprockets if specified.

Hardening Recommendations

Hardened teeth substantially increases sprocket life and is recommended under conditions listed below:

1. Pinion or driver where the reduction is 4:1 or greater.
2. Slow speed drives (100 FPM or less).
3. Where safety factor is less than standard.
4. Unusual abrasive conditions.

Degree of hardness — this is governed by conditions prevailing each application — for stock sprockets these general suggestions may be used as guide lines:

1. Rockwell "C" 35 to 50 pinion or driver.
2. Rockwell "C" 25 to 40 larger diameter or driver sprockets.

Induction or flame hardening will be used as best suited to the individual application. The diameter and pitch of the sprocket govern the method used.

Caution should be used to avoid "file hardness" (Rockwell C 62 and above) as it is not recommended for sprockets due to brittleness.

Depth of hardening should be limited so as to provide case only on the wear surfaces with a tough resilient core to absorb shock — (see illustration tooth section).

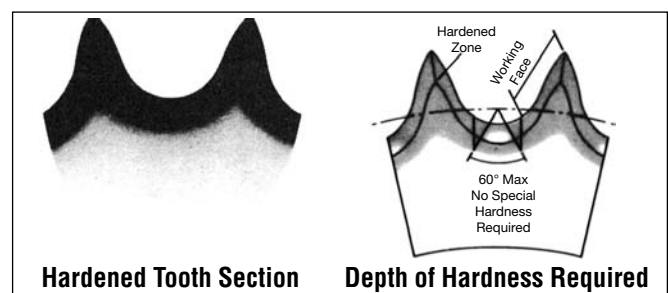

Chain Length Calculation

The following equation may be used to determine the chain length required for any two-sprocket drive.

$$L = 2C + \frac{N + n}{2} + \frac{.1013 (N - n)^2}{4C} \quad \text{or substituting A for } \frac{.1013 (N - n)^2}{4}, \quad L = 2C + \frac{N + n}{2} + \frac{A}{C}$$

where:

- C = Shaft Center Distance in pitches,
- L = Length of chain in pitches,
- N = Number of teeth in larger sprocket,
- n = Number of teeth in smaller sprocket,
- π = 3.1416,
- A = Value from table below tabulated for values of N-n,
- P = Pitch of chain.

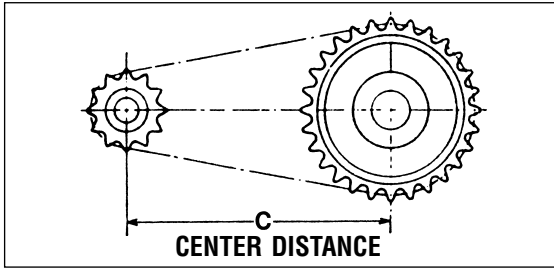

SPROCKETS

NOTE: The method described with above table of constants is sufficiently accurate for practically all commercial chain drives. When, however, a high degree of precision is necessary, especially if the drive is vertical, the following formula is useful in determining the exact centers for chain length already determined.

Calculation of shaft centers

The following formula is useful in determining the approximate centers in inches for chain lengths in pitches already determined.

$$C = \frac{P}{8} \left\{ 2L - N - n + \sqrt{(2L - N - n)^2 - 0.810 (N - n)^2} \right\}$$

Values of A For Chain Length Calculation

N-n	A	N-n	A	N-n	A	N-n	A	N-n	A	N-n	A
1	.03	32	25.94	63	100.54	94	223.82	125	395.79	156	616.44
2	.10	33	27.58	64	103.75	95	228.61	126	402.14	157	624.37
3	.23	34	29.28	65	107.02	96	233.44	127	408.55	158	632.35
4	.41	35	31.03	66	110.34	97	238.33	128	415.01	159	640.38
5	.63	36	32.83	67	113.71	98	243.27	129	421.52	160	648.46
6	.91	37	34.68	68	117.13	99	248.26	130	428.08	161	656.59
7	1.24	38	36.58	69	120.60	100	253.30	131	434.69	162	664.77
8	1.62	39	38.53	70	124.12	101	258.39	132	441.36	163	673.00
9	2.05	40	40.53	71	127.69	102	263.54	133	448.07	164	681.28
10	2.53	41	42.58	72	131.31	103	268.73	134	454.83	165	689.62
11	3.06	42	44.68	73	134.99	104	273.97	135	461.64	166	698.00
12	3.65	43	46.84	74	138.71	105	279.27	136	468.51	167	706.44
13	4.28	44	49.04	75	142.48	106	284.67	137	475.42	168	714.92
14	4.96	45	51.29	76	146.31	107	290.01	138	482.39	169	723.46
15	5.70	46	53.60	77	150.18	108	295.45	139	489.41	170	732.05
16	6.48	47	55.95	78	154.11	109	300.95	140	496.47	171	740.68
17	7.32	48	58.36	79	158.09	110	306.50	141	503.59	172	749.37
18	8.21	49	60.82	80	162.11	111	312.09	142	510.76	173	758.11
19	9.14	50	63.33	81	166.19	112	317.74	143	517.98	174	766.90
20	10.13	51	65.88	82	170.32	113	323.44	144	525.25	175	775.74
21	11.17	52	68.49	83	174.50	114	329.19	145	532.57	176	784.63
22	12.26	53	71.15	84	178.73	115	334.99	146	539.94	177	793.57
23	13.40	54	73.86	85	183.01	116	340.84	147	547.36	178	802.57
24	14.59	55	76.62	86	187.34	117	346.75	148	554.83	179	811.61
25	15.83	56	79.44	87	191.73	118	352.70	149	562.36	180	820.70
26	17.12	57	82.30	88	196.16	119	358.70	150	569.93	181	829.85
27	18.47	58	85.21	89	200.64	120	364.76	151	577.56	182	839.04
28	19.86	59	88.17	90	205.18	121	370.86	152	585.23	183	848.29
29	21.30	60	91.19	91	209.76	122	377.02	153	592.96	184	857.58
30	22.80	61	94.25	92	214.40	123	383.22	154	600.73	185	866.93
31	24.34	62	97.37	93	219.08	124	389.48	155	608.56		



Chain Drive Engineering

Roller Chain Lengths

No. Of Pitches	CHAIN PITCH — INCHES										
	3/8	1/2	5/8	3/4	1	1 1/4	1 1/2	1 3/4	2	2 1/2	3
	CHAIN LENGTHS — FEET										
1	0.0313	0.0417	0.0521	0.0625	0.0833	0.1042	0.1250	0.1458	0.1667	0.2083	0.2500
2	.0625	.0833	.1042	.1250	.1667	.2083	.2500	.2917	.3333	.4167	.5000
3	.0938	.1250	.1563	.1875	.2500	.3125	.3750	.4375	.5000	.6250	.7500
4	.1250	.1667	.2083	.2500	.3333	.4167	.5000	.5833	.6667	.8333	1.0000
5	.1563	.2083	.2604	.3125	.4167	.5208	.6250	.7292	.8333	1.0417	1.2500
6	.1875	.2500	.3125	.3750	.5000	.6250	.7500	.8750	1.0000	1.2500	1.5000
7	.2188	.2917	.3646	.4375	.5833	.7292	.8750	1.0208	1.1667	1.4583	1.7500
8	.2500	.3333	.4167	.5000	.6667	.8333	1.0000	1.1667	1.3333	1.6667	2.0000
9	.2813	.3750	.4688	.5625	.7500	.9375	1.1250	1.3125	1.5000	1.8750	2.2500
10	.3125	.4167	.5208	.6250	.8333	1.0417	1.2500	1.4583	1.6667	2.0833	2.5000
11	.3438	.4584	.5729	.6875	.9167	1.1459	1.3750	1.6041	1.8333	2.2917	2.7500
12	.3750	.5000	.6250	.7500	1.0000	1.2500	1.5000	1.7500	2.0000	2.5000	3.0000
13	.4063	.5417	.6771	.8125	1.0833	1.3542	1.6250	1.8958	2.1667	2.7083	3.2500
14	.4375	.5833	.7292	.8750	1.1667	1.4583	1.7500	2.0417	2.3333	2.9167	3.5000
15	.4688	.6250	.7813	.9375	1.2500	1.5625	1.8750	2.1875	2.5000	3.1250	3.7500
16	.5000	.6667	.8333	1.0000	1.3333	1.6667	2.0000	2.3333	2.6667	3.3333	4.0000
17	.5313	.7084	.8854	1.0625	1.4167	1.7709	2.1250	2.4791	2.8333	3.5417	4.2500
18	.5625	.7500	.9375	1.1250	1.5000	1.8750	2.2500	2.6250	3.0000	3.7500	4.5000
19	.5938	.7917	.9896	1.1875	1.5833	1.9792	2.3750	2.7708	3.1667	3.9583	4.7500
20	.6250	.8333	1.0417	1.2500	1.6667	2.0833	2.5000	2.9167	3.3333	4.1667	5.0000
21	.6563	.8750	1.0938	1.3125	1.7500	2.1875	2.6250	3.0625	3.5000	4.3750	5.2500
22	.6875	.9167	1.1458	1.3750	1.8333	2.2917	2.7500	3.2083	3.6667	4.5833	5.5000
23	.7188	.9584	1.1979	1.4375	1.9166	2.3959	2.8750	3.3541	3.8333	4.7917	5.7500
24	.7500	1.0000	1.2500	1.5000	2.0000	2.5000	3.0000	3.5000	4.0000	5.0000	6.0000
25	.7813	1.0417	1.3021	1.5625	2.0833	2.6042	3.1250	3.6458	4.1667	5.2083	6.2500
26	.8125	1.0833	1.3541	1.6250	2.1667	2.7083	3.2500	3.7917	4.3333	5.3167	6.5000
27	.8438	1.1250	1.4062	1.6875	2.2500	2.8125	3.3750	3.9375	4.5000	5.6250	6.7500
28	.8750	1.1667	1.4583	1.7500	2.3333	2.9167	3.5000	4.0833	4.6667	5.8333	7.0000
29	.9063	1.2084	1.5104	1.8125	2.4167	3.0209	3.6250	4.2291	4.8333	6.0417	7.2500
30	.9375	1.2500	1.5625	1.8750	2.5000	3.1250	3.7500	4.3750	5.0000	6.2500	7.5000
31	.9688	1.2917	1.6146	1.9375	2.5833	3.2292	3.8750	4.5208	5.1667	6.4583	7.7500
32	1.0000	1.3333	1.6667	2.0000	2.6667	3.3333	4.0000	4.6667	5.3333	6.6667	8.0000
33	1.0313	1.3750	1.7188	2.0625	2.7500	3.4375	4.1250	4.8125	5.5000	6.8750	8.2500
34	1.0625	1.4167	1.7708	2.1250	2.8333	3.5417	4.2500	4.9583	5.6667	7.0833	8.5000
35	1.0938	1.4584	1.8229	2.1875	2.9167	3.6459	4.3750	5.1041	5.8333	7.2917	8.7500
36	1.1250	1.5000	1.8750	2.2500	3.0000	3.7500	4.5000	5.2500	6.0000	7.5000	9.0000
37	1.1563	1.5417	1.9271	2.3125	3.0833	3.8542	4.6250	5.3958	6.1667	7.7083	9.2500
38	1.1875	1.5833	1.9791	2.3750	3.1667	3.9583	4.7500	5.5417	6.3333	7.9167	9.5000
39	1.2188	1.6250	2.0312	2.4375	3.2500	4.0625	4.8750	5.0875	6.5000	8.1250	9.7500
40	1.2500	1.6667	2.0833	2.5000	3.3333	4.1667	5.0000	5.8333	6.6667	8.3333	10.0000
41	1.2813	1.7084	2.1354	2.5625	3.4167	4.2709	5.1250	5.9791	6.8333	8.5417	10.2500
42	1.3125	1.7500	2.1875	2.6250	3.5000	4.3750	5.2500	6.1250	7.0000	8.7500	10.5000
43	1.3438	1.7917	2.2396	2.6875	3.5833	4.4792	5.3750	6.2708	7.1667	8.9583	10.7500
44	1.3750	1.8333	2.2916	2.7500	3.6667	4.5833	5.5000	6.4167	7.3333	9.1667	11.0000
45	1.4063	1.8750	2.3437	2.8125	3.7500	4.6875	5.6250	6.5625	7.5000	9.3750	11.2500
46	1.4375	1.9167	2.3958	2.8750	3.8333	4.7917	5.7500	6.7083	7.6667	9.5833	11.5000
47	1.4688	1.9584	2.4479	2.9375	3.9167	4.8959	5.8750	6.8541	7.8333	9.7917	11.7500
48	1.5000	2.0000	2.5000	3.0000	4.0000	5.0000	6.0000	7.0000	8.0000	10.0000	12.0000
49	1.5313	2.0417	2.5521	3.0625	4.0833	5.1042	6.1250	7.1458	8.1667	10.0283	12.2500
50	1.5625	2.0833	2.6042	3.1250	4.1667	5.2083	6.2500	7.2917	8.3333	10.4167	12.5000
51	1.5938	2.1250	2.6563	3.1875	4.2500	5.3125	6.3750	7.4375	8.5000	10.6250	12.7500
52	1.6250	2.1667	2.7083	3.2500	4.3333	5.4167	6.5000	7.5833	8.6667	10.8333	13.0000
53	1.6563	2.2084	2.7604	3.3125	4.4167	5.5209	6.6250	7.7291	8.8333	11.0417	13.2500
54	1.6875	2.2500	2.8125	3.3750	4.5000	5.6250	6.7500	7.8750	9.0000	11.2500	13.5000
55	1.7188	2.2917	2.8647	3.4375	4.5833	5.7292	6.8750	8.0208	9.1667	11.4583	13.7500
56	1.7500	2.3333	2.9167	3.5000	4.6667	5.8333	7.0000	8.1667	9.3333	11.6667	14.0000
57	1.7813	2.3750	2.9688	3.5625	4.7500	5.9375	7.1250	8.3125	9.5000	11.8750	14.2500
58	1.8125	2.4167	3.0208	3.6250	4.8333	6.0417	7.2500	8.4583	9.6667	12.0833	14.5000
59	1.8438	2.4584	3.0729	3.6875	4.9167	6.1459	7.3750	8.6041	9.8333	12.2917	14.7500
60	1.8750	2.5000	3.1250	3.7500	5.0000	6.2500	7.5000	8.7500	10.0000	12.5000	15.0000
61	1.9063	2.5417	3.1771	3.8125	5.0833	6.3542	7.6250	8.8958	10.1667	12.7083	15.2500
62	1.9375	2.5833	3.2292	3.8750	5.1667	6.4583	7.7500	9.0417	10.3333	12.9167	15.5000
63	1.9688	2.6250	3.2813	3.9375	5.2500	6.5625	7.8750	9.1875	10.5000	13.1250	15.7500
64	2.0000	2.6667	3.3333	4.0000	5.3333	6.6667	8.0000	9.3333	10.6667	13.3333	16.0000
65	2.0313	2.7084	3.3854	4.0625	5.4167	6.7709	8.1250	9.4791	10.8333	13.5417	16.2500
66	2.0625	2.7500	3.4375	4.1250	5.5000	6.8750	8.2500	9.6250	11.0000	13.7500	16.5000
67	2.0938	2.7917	3.4897	4.1875	5.5833	6.9792	8.3750	9.7708	11.1667	13.9583	16.7500
68	2.1250	2.8333	3.5417	4.2500	5.6667	7.0833	8.5000	9.9167	11.3333	14.1667	17.0000
69	2.1563	2.8750	3.5938	4.3125	5.7500	7.1875	8.6250	10.0625	11.5000	14.3750	17.2500
70	2.1875	2.9167	3.6458	4.3750	5.8333	7.2917	8.7500	10.2083	11.6667	14.5833	17.5000
71	2.2188	2.9584	3.6979	4.4375	5.9167	7.3959	8.8750	10.3541	11.8333	14.7917	17.7500
72	2.2500	3.0000	3.7500	4.5000	6.0000	7.5000	9.0000	10.5000	12.0000	15.0000	18.0000
73	2.2813	3.0417	3.8021	4.5625	6.0833	7.6042	9.1250	10.6458	12.1667	15.2083	18.2500
74	2.3125	3.0833	3.8541	4.6250	6.1667	7.7083	9.2500	10.7917	12.3333	15.4167	18.5000
75	2.3438	3.1250	3.9062	4.6875	6.2500	7.8125	9.3750	10.9375	12.5000	15.6250	18.7500
80	2.5000	3.3333	4.1667	5.0000	6.6667	8.3333	10.0000	11.6667	13.3333	16.6667	20.0000
85	2.6563	3.5417	4.4271	5.3125	7.0833	8.8542	10.6250	12.3958	14.1667	17.7083	21.2500
90	2.8125	3.7500	4.6875	5.6250	7.5000	9.3750	11.2500	13.1250	15.0000	18.7500	22.5000
95	2.9688	3.9584	4.9479	5.9375	7.9167	9.8959	11.8750	13.8541	15.8333	19.7917	23.5000
100	3.1250	4.1667	5.2083	6.2500	8.3333	10.4167	12.5000	14.5833	16.6667	20.8333	25.0000

SPROCKETS

Speed Ratios For Sprocket Combinations Driver Sprocket Teeth

SPROCKETS

	9	10	11	12	13	14	15	16	17	18	19	20	21	22	23	24	25	26
9	1.00																	
10	1.11	1.00																
11	1.22	1.10	1.00															
12	1.33	1.20	1.09	1.00														
13	1.44	1.30	1.18	1.08	1.00													
14	1.56	1.40	1.27	1.17	1.08	1.00												
15	1.67	1.50	1.36	1.25	1.15	1.07	1.00											
16	1.78	1.60	1.45	1.33	1.23	1.14	1.07	1.00										
17	1.89	1.70	1.55	1.42	1.31	1.21	1.13	1.06	1.00									
18	2.00	1.80	1.64	1.50	1.38	1.29	1.20	1.13	1.06	1.00								
19	2.11	1.90	1.73	1.58	1.46	1.36	1.27	1.19	1.12	1.06	1.00							
20	2.22	2.00	1.82	1.67	1.54	1.43	1.33	1.25	1.18	1.11	1.05	1.00						
21	2.33	2.10	1.91	1.75	1.61	1.50	1.40	1.31	1.23	1.17	1.10	1.05	1.00					
22	2.44	2.20	2.00	1.83	1.69	1.57	1.47	1.38	1.29	1.22	1.16	1.10	1.05	1.00				
23	2.56	2.30	2.09	1.92	1.77	1.64	1.53	1.44	1.35	1.28	1.21	1.15	1.09	1.04	1.00			
24	2.67	2.40	2.18	2.00	1.85	1.71	1.60	1.50	1.41	1.33	1.26	1.20	1.14	1.09	1.04	1.00		
25	2.78	2.50	2.27	2.08	1.92	1.79	1.67	1.56	1.47	1.39	1.32	1.25	1.19	1.14	1.09	1.04	1.00	
26	2.89	2.60	2.36	2.17	2.00	1.86	1.73	1.63	1.53	1.45	1.37	1.30	1.24	1.18	1.13	1.08	1.04	1.00
27	3.00	2.70	2.45	2.25	2.08	1.93	1.80	1.69	1.59	1.50	1.42	1.35	1.29	1.23	1.17	1.12	1.08	1.04
28	3.11	2.80	2.54	2.33	2.15	2.00	1.87	1.75	1.65	1.56	1.47	1.40	1.33	1.27	1.22	1.17	1.12	1.08
29	3.22	2.90	2.64	2.42	2.23	2.07	1.93	1.81	1.71	1.61	1.53	1.45	1.38	1.32	1.26	1.21	1.16	1.12
30	3.33	3.00	2.73	2.50	2.31	2.14	2.00	1.88	1.76	1.67	1.58	1.50	1.43	1.36	1.31	1.25	1.20	1.15
31	3.44	3.10	2.82	2.58	2.38	2.21	2.07	1.94	1.82	1.72	1.63	1.55	1.48	1.41	1.35	1.29	1.24	1.19
32	3.56	3.20	2.91	2.67	2.46	2.28	2.13	2.00	1.88	1.78	1.68	1.60	1.52	1.45	1.39	1.33	1.28	1.23
33	3.67	3.30	3.00	2.75	2.54	2.36	2.20	2.06	1.94	1.83	1.74	1.65	1.57	1.50	1.43	1.38	1.32	1.27
34	3.78	3.40	3.09	2.83	2.62	2.43	2.27	2.13	2.00	1.89	1.79	1.70	1.62	1.55	1.48	1.42	1.36	1.31
35	3.89	3.50	3.18	2.92	2.69	2.50	2.33	2.19	2.06	1.95	1.84	1.75	1.67	1.59	1.52	1.46	1.40	1.34
36	4.00	3.60	3.27	3.00	2.77	2.57	2.40	2.25	2.12	2.00	1.89	1.80	1.71	1.63	1.57	1.50	1.44	1.38
37	4.11	3.70	3.36	3.08	2.85	2.64	2.47	2.31	2.18	2.06	1.95	1.85	1.76	1.68	1.61	1.54	1.48	1.42
38	4.22	3.80	3.45	3.17	2.92	2.71	2.53	2.38	2.24	2.11	2.00	1.90	1.81	1.73	1.65	1.58	1.52	1.46
39	4.33	3.90	3.55	3.25	3.00	2.79	2.60	2.44	2.29	2.17	2.05	1.95	1.86	1.77	1.70	1.63	1.56	1.50
40	4.44	4.00	3.64	3.33	3.08	2.86	2.67	2.50	2.35	2.22	2.10	2.00	1.90	1.82	1.74	1.67	1.60	1.54
41	4.56	4.10	3.73	3.42	3.15	2.93	2.73	2.56	2.41	2.28	2.16	2.05	1.95	1.86	1.78	1.71	1.64	1.58
42	4.67	4.20	3.82	3.50	3.23	3.00	2.80	2.63	2.47	2.34	2.21	2.10	2.00	1.91	1.83	1.75	1.68	1.61
43	4.78	4.30	3.91	3.58	3.31	3.07	2.87	2.69	2.53	2.39	2.26	2.15	2.05	1.95	1.87	1.79	1.72	1.65
44	4.89	4.40	4.00	3.67	3.39	3.14	2.93	2.75	2.59	2.44	2.32	2.20	2.10	2.00	1.91	1.83	1.76	1.69
45	5.00	4.50	4.09	3.75	3.46	3.21	3.00	2.81	2.65	2.50	2.37	2.25	2.14	2.04	1.96	1.88	1.80	1.73
46	5.11	4.60	4.18	3.83	3.54	3.29	3.07	2.88	2.71	2.56	2.42	2.30	2.19	2.09	2.00	1.92	1.84	1.77
47	5.22	4.70	4.27	3.92	3.62	3.36	3.13	2.94	2.76	2.61	2.47	2.35	2.24	2.14	2.04	1.96	1.88	1.81
48	5.33	4.80	4.36	4.00	3.69	3.43	3.20	3.00	2.82	2.67	2.52	2.40	2.28	2.18	2.09	2.00	1.92	1.84
49	5.44	4.90	4.45	4.08	3.77	3.50	3.27	3.06	2.88	2.72	2.58	2.45	2.33	2.23	2.13	2.04	1.96	1.88
50	5.56	5.00	4.55	4.17	3.85	3.57	3.33	3.13	2.94	2.78	2.63	2.50	2.38	2.27	2.17	2.08	2.00	1.92
51	5.67	5.10	4.64	4.25	3.92	3.64	3.40	3.19	3.00	2.83	2.68	2.55	2.43	2.32	2.22	2.13	2.04	1.96
52	5.78	5.20	4.73	4.33	4.00	3.71	3.47	3.25	3.06	2.89	2.74	2.60	2.48	2.36	2.26	2.17	2.08	2.00
53	5.89	5.30	4.82	4.42	4.08	3.79	3.53	3.31	3.12	2.94	2.79	2.65	2.52	2.41	2.30	2.21	2.12	2.04
54	6.00	5.40	4.91	4.50	4.15	3.86	3.60	3.38	3.18	3.00	2.84	2.70	2.57	2.45	2.35	2.25	2.16	2.07
55	6.11	5.50	5.00	4.58	4.23	3.93	3.67	3.44	3.24	3.06	2.90	2.75	2.62	2.50	2.39	2.29	2.20	2.12
56	6.22	5.60	5.09	4.67	4.31	4.00	3.73	3.50	3.29	3.11	2.95	2.80	2.67	2.55	2.43	2.33	2.24	2.15
57	6.33	5.70	5.18	4.75	4.38	4.07	3.80	3.56	3.35	3.17	3.00	2.85	2.71	2.59	2.48	2.38	2.28	2.19
58	6.44	5.80	5.27	4.83	4.46	4.14	3.87	3.63	3.41	3.22	3.05	2.90	2.76	2.64	2.52	2.42	2.32	2.23
59	6.56	5.90	5.36	4.92	4.54	4.21	3.93	3.69	3.47	3.28	3.11	2.95	2.81	2.68	2.57	2.46	2.36	2.27
60	6.67	6.00	5.45	5.00	4.61	4.28	4.00	3.75	3.53	3.34	3.16	3.00	2.86	2.72	2.61	2.50	2.40	2.30
68	7.55	6.80	6.18	5.66	5.23	4.86	4.54	4.25	4.00	3.78	3.58	3.40	3.24	3.09	2.96	2.84	2.72	2.61
70	7.78	7.00	6.36	5.83	5.38	5.00	4.67	4.38	4.12	3.89	3.68	3.50	3.33	3.18	3.05	2.92	2.80	2.69
72	8.00	7.20	6.54	6.00	5.54	5.14	4.80	4.50	4.24	4.00	3.79	3.60	3.43	3.27	3.13	3.00	2.88	2.77
76			6.91	6.33	5.84	5.43	5.07	4.75	4.47	4.23	4.00	3.80	3.62	3.45	3.31	3.17	3.04	2.92
80			7.27	6.66	6.15	5.71	5.34	5.00	4.70	4.45	4.21	4.00	3.81	3.63	3.48	3.34	3.20	3.07
84				7.00	6.46	6.00	5.60	5.25	4.94	4.67	4.42	4.20	4.00	3.81	3.65	3.50	3.36	3.23
95					7.31	6.78	6.33	5.94	5.59	5.28	5.00	4.75	4.52	4.32	4.13	3.96	3.80	3.65
96					7.38	6.85	6.40	6.00	5.64	5.34	5.05	4.80	4.57	4.36	4.18	4.00	3.84	3.69
102						7.28	6.80	6.38	6.00	5.67	5.37	5.10	4.86	4.63	4.44	4.25	4.08	3.92
112								7.00	6.59	6.23	5.89	5.60	5.33	5.08	4.87	4.67	4.48	4.30

Martin stock sprockets in pitches No. 40 through No. 100 are available with 8 to 60 teeth inclusive and in all common larger sizes for all pitches.



Sprocket Diameters

No. 25 1/4" Pitch

ROLLER CHAIN SPROCKET DIAMETERS

No. Teeth	Pitch Diameter	Outside Diameter	Caliper Diameter	No. Teeth	Pitch Diameter	Outside Diameter	Caliper Diameter	No. Teeth	Pitch Diameter	Outside Diameter	Caliper Diameter
6	.500	.583	.370	71	5.652	5.796	5.521	136	10.823	10.970	10.693
7	.576	.669	.432	72	5.732	5.876	5.602	137	10.903	11.050	10.772
8	.653	.754	.523	73	5.811	5.956	5.680	138	10.983	11.130	10.853
9	.731	.837	.591	74	5.891	6.035	5.761	139	11.062	11.209	10.932
10	.809	.919	.679	75	5.970	6.115	5.839	140	11.142	11.289	11.012
11	.887	1.002	.748	76	6.050	6.195	5.920	141	11.221	11.369	11.091
12	.966	1.083	.836	77	6.129	6.274	5.998	142	11.301	11.448	11.171
13	1.045	1.167	.907	78	6.209	6.354	6.079	143	11.380	11.528	11.250
14	1.124	1.246	.994	79	6.288	6.433	6.157	144	11.460	11.607	11.330
15	1.203	1.326	1.066	80	6.368	6.513	6.238	145	11.540	11.687	11.409
16	1.282	1.407	1.152	81	6.448	6.593	6.317	146	11.619	11.767	11.489
17	1.361	1.487	1.225	82	6.527	6.672	6.397	147	11.699	11.846	11.568
18	1.440	1.568	1.310	83	6.607	6.752	6.476	148	11.779	11.926	11.649
19	1.519	1.648	1.383	84	6.686	6.832	6.556	149	11.858	12.005	11.727
20	1.598	1.729	1.468	85	6.766	6.911	6.635	150	11.938	12.084	11.807
21	1.678	1.809	1.543	86	6.845	6.991	6.715	151	12.017	12.164	11.886
22	1.757	1.889	1.627	87	6.925	7.070	6.794	152	12.097	12.244	11.966
23	1.836	1.969	1.702	88	7.004	7.150	6.874	153	12.176	12.323	12.045
24	1.915	2.049	1.785	89	7.084	7.230	6.953	154	12.256	12.403	12.125
25	1.995	2.129	1.861	90	7.164	7.309	7.034	155	12.335	12.482	12.204
26	2.074	2.209	1.944	91	7.243	7.389	7.112	156	12.415	12.562	12.284
27	2.154	2.289	2.020	92	7.323	7.468	7.193	157	12.494	12.641	12.363
28	2.233	2.369	2.103	93	7.402	7.548	7.271	158	12.574	12.721	12.444
29	2.312	2.449	2.179	94	7.482	7.628	7.352	159	12.654	12.801	12.523
30	2.392	2.529	2.262	95	7.561	7.707	7.430	160	12.733	12.881	12.603
31	2.471	2.609	2.338	96	7.641	7.787	7.511	161	12.813	12.960	12.682
32	2.551	2.688	2.421	97	7.720	7.866	7.589	162	12.893	13.039	12.762
33	2.630	2.768	2.497	98	7.800	7.946	7.670	163	12.972	13.119	12.841
34	2.710	2.848	2.580	99	7.880	8.026	7.749	164	13.051	13.199	12.921
35	2.789	2.928	2.656	100	7.959	8.105	7.829	165	13.131	13.278	13.000
36	2.869	3.008	2.739	101	8.039	8.185	7.908	166	13.211	13.357	13.080
37	2.948	3.087	2.815	102	8.118	8.264	7.988	167	13.290	13.437	13.159
38	3.028	3.167	2.898	103	8.198	8.344	8.067	168	13.370	13.517	13.239
39	3.107	3.247	2.975	104	8.277	8.424	8.147	169	13.450	13.597	13.318
40	3.187	3.327	3.057	105	8.357	8.503	8.226	170	13.529	13.676	13.398
41	3.266	3.406	3.134	106	8.437	8.583	8.307	171	13.608	13.756	13.477
42	3.346	3.486	3.216	107	8.516	8.662	8.385	172	13.688	13.835	13.558
43	3.425	3.566	3.293	108	8.596	8.742	8.466	173	13.768	13.915	13.637
44	3.505	3.646	3.375	109	8.675	8.822	8.544	174	13.847	13.995	13.717
45	3.584	3.725	3.452	110	8.755	8.901	8.625	175	13.927	14.074	13.796
46	3.664	3.805	3.534	111	8.834	8.981	8.703	176	14.006	14.154	13.876
47	3.743	3.885	3.611	112	8.914	9.060	8.784	177	14.086	14.233	13.955
48	3.823	3.964	3.693	113	8.994	9.140	8.863	178	14.166	14.313	14.035
49	3.902	4.044	3.770	114	9.073	9.220	8.943	179	14.245	14.392	14.114
50	3.982	4.124	3.852	115	9.153	9.299	9.022	180	14.325	14.472	14.195
51	4.061	4.203	3.929	116	9.232	9.379	9.102	181	14.404	14.551	14.273
52	4.141	4.283	4.011	117	9.312	9.458	9.181	182	14.484	14.631	14.353
53	4.220	4.363	4.088	118	9.391	9.538	9.261	183	14.564	14.711	14.433
54	4.300	4.442	4.170	119	9.471	9.618	9.340	184	14.643	14.790	14.513
55	4.379	4.522	4.247	120	9.550	9.697	9.420	185	14.722	14.870	14.591
56	4.459	4.602	4.329	121	9.630	9.777	9.499	186	14.803	14.949	14.672
57	4.538	4.681	4.407	122	9.709	9.856	9.579	187	14.882	15.029	14.751
58	4.618	4.761	4.488	123	9.789	9.936	9.658	188	14.961	15.109	14.831
59	4.697	4.841	4.566	124	9.869	10.016	9.739	189	15.041	15.188	14.910
60	4.777	4.920	4.647	125	9.949	10.095	9.818	190	15.120	15.268	14.990
61	4.857	5.000	4.725	126	10.028	10.175	9.898	191	15.200	15.347	15.069
62	4.936	5.080	4.806	127	10.108	10.255	9.977	192	15.279	15.427	15.149
63	5.016	5.159	4.884	128	10.187	10.334	10.057	193	15.359	15.507	15.228
64	5.095	5.239	4.965	129	10.267	10.414	10.136	194	15.439	15.586	15.308
65	5.175	5.319	5.044	130	10.346	10.493	10.216	195	15.518	15.666	15.387
66	5.254	5.398	5.124	131	10.426	10.573	10.295	196	15.598	15.745	15.467
67	5.334	5.478	5.203	132	10.505	10.652	10.375	197	15.678	15.824	15.547
68	5.413	5.558	5.283	133	10.585	10.732	10.454	198	15.757	15.904	15.626
69	5.493	5.637	5.362	134	10.664	10.811	10.534	199	15.837	15.984	15.706
70	5.572	5.717	5.442	135	10.744	10.891	10.613	200	15.916	16.064	15.786

SPROCKETS

Odd tooth "bottom diameters" equal pitch diameters minus .130".

No. 35
3/8" Pitch

**Sprocket
Diameters**

Martin

ROLLER CHAIN SPROCKET DIAMETERS

No. Teeth	Pitch Diameter	Outside Diameter	Caliper Diameter	No. Teeth	Pitch Diameter	Outside Diameter	Caliper Diameter	No. Teeth	Pitch Diameter	Outside Diameter	Caliper Diameter
5	.638	.741	.407	71	8.478	8.694	8.276	136	16.235	16.456	16.035
6	.750	.875	.550	72	8.597	8.814	8.397	137	16.355	16.575	16.154
7	.864	1.004	.643	73	8.717	8.933	8.514	138	16.474	16.695	16.274
8	9.80	1.130	.780	74	8.836	9.053	8.636	139	16.593	16.814	16.392
9	1.097	1.256	.880	75	8.955	9.172	8.753	140	16.713	16.934	16.513
10	1.214	1.379	1.014	76	9.074	9.292	8.874	141	16.832	17.053	16.631
11	1.331	1.502	1.117	77	9.194	9.411	8.992	142	16.952	17.172	16.752
12	1.449	1.625	1.249	78	9.313	9.531	9.113	143	17.071	17.292	16.870
13	1.567	1.746	1.356	79	9.432	9.650	9.231	144	17.190	17.411	16.990
14	1.685	1.868	1.485	80	9.552	9.770	9.352	145	17.309	17.531	17.108
15	1.804	1.989	1.594	81	9.671	9.889	9.469	146	17.429	17.650	17.229
16	1.922	2.110	1.722	82	9.791	10.008	9.591	147	17.548	17.769	17.347
17	2.041	2.231	1.832	83	9.910	10.128	9.708	148	17.667	17.889	17.467
18	2.160	2.352	1.960	84	10.029	10.247	9.829	149	17.787	18.008	17.586
19	2.279	2.472	2.071	85	10.148	10.367	9.947	150	17.906	18.128	17.706
20	2.397	2.593	2.197	86	10.268	10.486	10.068	151	18.026	18.247	17.825
21	2.516	2.713	2.309	87	10.387	10.605	10.285	152	18.145	18.366	17.945
22	2.635	2.833	2.435	88	10.506	10.725	10.306	153	18.264	18.486	18.063
23	2.754	2.954	2.548	89	10.626	10.844	10.424	154	18.384	18.605	18.184
24	2.873	3.074	2.673	90	10.745	10.964	10.545	155	18.503	18.724	18.302
25	2.992	3.194	2.786	91	10.865	11.083	10.663	156	18.623	18.844	18.423
26	3.111	3.314	2.911	92	10.934	11.202	10.784	157	18.742	18.963	18.541
27	3.230	3.434	3.025	93	11.103	11.322	10.902	158	18.861	19.082	18.661
28	3.349	3.553	3.149	94	11.223	11.441	11.023	159	18.981	19.202	18.780
29	3.468	3.673	3.263	95	11.342	11.561	11.140	160	19.100	19.321	18.900
30	3.588	3.793	3.388	96	11.461	11.680	11.261	161	19.219	19.440	19.018
31	3.707	3.913	3.502	97	11.581	11.799	11.379	162	19.338	19.560	19.138
32	3.826	4.032	3.626	98	11.700	11.919	11.500	163	19.458	19.679	19.257
33	3.945	4.152	3.741	99	11.819	12.038	11.618	164	19.577	19.799	19.377
34	4.064	4.272	3.864	100	11.939	12.158	11.739	165	19.697	19.918	19.496
35	4.184	4.392	3.979	101	12.058	12.277	11.856	166	19.816	20.037	19.616
36	4.303	4.511	4.103	102	12.177	12.396	11.977	167	19.935	20.090	19.734
37	4.422	4.631	4.218	103	12.297	12.516	12.095	168	20.055	20.276	19.855
38	4.541	4.751	4.341	104	12.416	12.635	12.216	169	20.174	20.396	19.973
39	4.661	4.870	4.457	105	12.536	12.755	12.334	170	20.294	20.515	20.094
40	4.780	4.990	4.580	106	12.655	12.874	12.455	171	20.413	20.634	20.212
41	4.899	5.109	4.695	107	12.774	12.993	12.573	172	20.532	20.754	20.332
42	5.018	5.229	4.818	108	12.893	13.113	12.693	173	20.652	20.873	20.451
43	5.138	5.349	4.934	109	13.013	13.232	12.811	174	20.771	20.993	20.571
44	5.257	5.468	5.057	110	13.132	13.352	12.932	175	20.890	21.112	20.689
45	5.376	5.588	5.173	111	13.251	13.471	13.050	176	21.010	21.231	20.810
46	5.495	5.707	5.295	112	13.371	13.590	13.171	177	21.129	21.351	20.928
47	5.615	5.827	5.411	113	13.490	13.710	13.289	178	21.248	21.470	21.048
48	5.734	5.946	5.534	114	13.610	13.829	13.410	179	21.368	21.589	21.167
49	5.853	6.066	5.650	115	13.729	13.949	13.528	180	21.487	21.709	21.287
50	5.972	6.186	5.772	116	13.848	14.068	13.648	181	21.606	21.828	21.406
51	6.092	6.305	5.889	117	13.968	14.187	13.766	182	21.726	21.948	21.526
52	6.211	6.425	6.011	118	14.087	14.307	13.887	183	21.845	22.067	21.644
53	6.330	6.544	6.127	119	14.206	14.426	14.005	184	21.965	22.186	21.765
54	6.449	6.663	6.249	120	14.326	14.546	14.126	185	22.084	22.306	21.883
55	6.569	6.783	6.366	121	14.445	14.665	14.244	186	22.203	22.425	22.003
56	6.688	6.903	6.488	122	14.564	14.784	14.364	187	22.323	22.544	22.122
57	6.807	7.022	6.605	123	14.684	14.904	14.482	188	22.442	22.664	22.242
58	6.927	7.142	6.727	124	14.803	15.023	14.603	189	22.561	22.783	22.360
59	7.046	7.261	6.843	125	14.922	15.143	14.721	190	22.681	22.902	22.481
60	7.165	7.380	6.965	126	15.042	15.262	14.842	191	22.800	23.022	22.599
61	7.285	7.500	7.082	127	15.161	15.381	14.960	192	22.919	23.141	22.719
62	7.404	7.619	7.204	128	15.281	15.501	15.081	193	23.039	23.261	22.838
63	7.523	7.739	7.321	129	15.400	15.620	15.199	194	23.158	23.380	22.958
64	7.643	7.859	7.443	130	15.519	15.740	15.319	195	23.277	23.499	23.177
65	7.762	7.978	7.560	131	15.639	15.859	15.437	196	23.397	23.619	23.197
66	7.881	8.097	7.681	132	15.758	15.978	15.558	197	23.516	23.738	23.315
67	8.001	8.217	7.798	133	15.877	16.098	15.676	198	23.636	23.858	23.436
68	8.120	8.336	7.920	134	15.996	16.217	15.796	199	23.755	23.977	23.554
69	8.239	8.456	8.037	135	16.116	16.337	15.915	200	23.874	24.096	23.674
70	8.358	8.575	8.158								

SPROCKETS



Sprocket Diameters

No. 40 1/2" Pitch

ROLLER CHAIN SPROCKET DIAMETERS

No. Teeth	Pitch Diameter	Outside Diameter	Caliper Diameter	No. Teeth	Pitch Diameter	Outside Diameter	Caliper Diameter	No. Teeth	Pitch Diameter	Outside Diameter	Caliper Diameter
5	.851	.988	.497	71	11.304	11.592	10.988	136	21.647	21.941	21.334
6	1.000	1.166	.688	72	11.463	11.752	11.151	137	21.806	22.100	21.492
7	1.152	1.338	.812	73	11.622	11.911	11.306	138	21.965	22.259	21.653
8	1.307	1.507	.995	74	11.781	12.070	11.468	139	22.124	22.419	21.810
9	1.462	1.674	1.127	75	11.940	12.229	11.625	140	22.284	22.578	21.971
10	1.618	1.839	1.305	76	12.099	12.389	11.786	141	22.442	22.737	22.129
11	1.775	2.003	1.444	77	12.258	12.548	11.943	142	22.602	22.896	22.289
12	1.932	2.166	1.614	78	12.417	12.707	12.105	143	22.761	23.055	22.447
13	2.089	2.328	1.761	79	12.576	12.866	12.261	144	22.920	23.214	22.607
14	2.247	2.490	1.934	80	12.736	13.026	12.423	145	23.079	23.374	22.765
15	2.405	2.652	2.079	81	12.895	13.185	12.580	146	23.238	23.533	22.926
16	2.563	2.814	2.250	82	13.054	13.344	12.742	147	23.398	23.692	23.088
17	2.721	2.974	2.397	83	13.213	13.503	12.898	148	23.557	23.851	23.244
18	2.879	3.136	2.567	84	13.372	13.663	13.059	149	23.716	24.010	23.402
19	3.038	3.292	2.715	85	13.531	13.822	13.216	150	23.875	24.170	23.562
20	3.196	3.457	2.883	86	13.690	13.981	13.373	151	24.034	24.329	23.720
21	3.355	3.618	3.033	87	13.849	14.140	13.534	152	24.193	24.488	23.880
22	3.513	3.778	3.201	88	14.009	14.299	13.696	153	24.352	24.647	24.038
23	3.672	3.938	3.351	89	14.168	14.459	13.853	154	24.512	24.806	24.199
24	3.831	4.098	3.518	90	14.327	14.618	14.014	155	24.672	24.965	24.357
25	3.989	4.258	3.669	91	14.486	14.777	14.171	156	24.830	25.124	24.517
26	4.148	4.418	3.835	92	14.645	14.936	14.332	157	24.989	25.284	24.675
27	4.307	4.578	3.987	93	14.804	15.096	14.489	158	24.148	25.443	24.835
28	4.465	4.738	4.153	94	14.963	15.255	14.651	159	25.307	25.602	24.993
29	4.625	4.898	4.305	95	15.122	15.414	14.808	160	25.466	25.761	25.154
30	4.783	5.057	4.471	96	15.282	15.573	14.969	161	25.625	25.920	25.312
31	4.942	5.217	4.623	97	15.441	15.732	15.126	162	25.785	26.080	25.472
32	5.101	5.376	4.788	98	15.600	15.892	15.287	163	25.944	26.239	25.630
33	5.260	5.536	4.941	99	15.759	16.051	15.445	164	26.103	26.398	25.790
34	5.419	5.696	5.107	100	15.918	16.210	15.605	165	26.262	26.557	25.948
35	5.578	5.856	5.260	101	16.077	16.369	15.763	166	26.421	26.716	26.109
36	5.737	6.015	5.425	102	16.236	16.528	15.924	167	26.581	26.876	26.266
37	5.896	6.174	5.578	103	16.395	16.688	16.081	168	26.739	27.035	26.427
38	6.055	6.334	5.742	104	16.555	16.847	16.242	169	26.899	27.194	26.585
39	6.214	6.494	5.896	105	16.714	17.006	16.399	170	27.058	27.353	26.745
40	6.373	6.653	6.061	106	16.873	17.165	16.561	171	27.217	27.512	26.903
41	6.532	6.812	6.214	107	17.032	17.324	16.717	172	27.376	27.671	27.063
42	6.691	6.972	6.379	108	17.191	17.484	16.878	173	27.535	27.831	27.221
43	6.850	7.132	6.532	109	17.351	17.643	17.036	174	27.694	27.990	27.382
44	7.009	7.291	6.696	110	17.509	17.802	17.197	175	27.854	28.149	27.540
45	7.168	7.450	6.851	111	17.668	17.962	17.304	176	28.013	28.308	27.700
46	7.327	7.609	7.014	112	17.827	18.121	17.515	177	28.172	28.467	27.858
47	7.486	7.769	7.169	113	17.987	18.280	17.672	178	28.331	28.626	28.018
48	7.645	7.928	7.332	114	18.146	18.439	17.834	179	28.490	28.786	28.176
49	7.804	8.088	7.487	115	18.305	18.598	17.991	180	28.649	28.945	28.337
50	7.963	8.248	7.650	116	18.464	18.757	18.151	181	28.808	29.104	28.495
51	8.122	8.406	7.805	117	18.623	18.916	18.309	182	28.968	29.263	28.655
52	8.281	8.566	7.968	118	18.782	19.076	18.470	183	29.127	29.422	28.813
53	8.440	8.725	8.124	119	18.941	19.235	18.627	184	29.286	29.581	28.973
54	8.599	8.884	8.286	120	19.101	19.394	18.788	185	29.445	29.741	29.131
55	8.758	9.044	8.442	121	19.260	19.553	18.946	186	29.604	29.900	29.291
56	8.917	9.204	8.605	122	19.419	19.712	19.106	187	29.763	30.059	29.450
57	9.077	9.362	8.760	123	19.578	19.872	19.264	188	29.922	30.218	29.610
58	9.235	9.522	8.924	124	19.737	20.031	19.425	189	30.082	30.377	29.768
59	9.395	9.682	9.078	125	19.896	20.190	19.582	190	30.241	30.536	29.928
60	9.554	9.840	9.241	126	20.056	20.349	19.743	191	30.400	30.696	30.086
61	9.713	10.000	9.397	127	20.215	20.508	19.900	192	30.559	30.855	30.246
62	9.872	10.159	9.559	128	20.374	20.667	20.061	193	30.718	31.014	30.404
63	10.031	10.319	9.715	129	20.533	20.827	20.219	194	30.877	31.173	30.565
64	10.190	10.478	9.872	130	20.692	20.986	20.379	195	31.037	31.332	30.723
65	10.349	10.637	10.033	131	20.851	21.145	20.537	196	31.196	31.491	30.878
66	10.508	10.796	10.195	132	21.010	21.304	20.698	197	31.355	31.651	31.042
67	10.667	10.955	10.352	133	21.169	21.463	20.855	198	31.514	31.810	31.202
68	10.826	11.115	10.514	134	21.329	21.623	21.016	199	31.673	31.969	31.359
69	10.985	11.274	10.670	135	21.488	21.782	21.174	200	31.832	32.128	31.520
70	11.145	11.433	10.832								

SPROCKETS

No. 50
5/8" Pitch

**Sprocket
Diameters**

Martin

ROLLER CHAIN SPROCKET DIAMETERS

No. Teeth	Pitch Diameter	Outside Diameter	Caliper Diameter	No. Teeth	Pitch Diameter	Outside Diameter	Caliper Diameter	No. Teeth	Pitch Diameter	Outside Diameter	Caliper Diameter
5	1.063	1.235	.611	71	14.129	14.491	13.726	136	27.059	27.426	26.659
6	1.250	1.458	.850	72	14.329	14.690	13.929	137	27.258	27.626	26.856
7	1.441	1.673	1.104	73	14.528	14.889	14.124	138	27.457	27.824	27.057
8	1.633	1.884	1.233	74	14.726	15.088	14.326	139	27.656	28.024	27.254
9	1.828	2.093	1.400	75	14.925	15.287	14.522	140	27.854	28.223	27.454
10	2.023	2.299	1.623	76	15.124	15.486	14.724	141	28.053	28.421	27.652
11	2.219	2.504	1.796	77	15.323	15.685	14.920	142	28.253	28.621	27.853
12	2.415	2.708	2.015	78	15.522	15.884	15.122	143	28.451	28.819	28.050
13	2.612	2.911	2.193	79	15.721	16.083	15.318	144	28.650	29.018	28.250
14	2.809	3.113	2.409	80	15.919	16.283	15.519	145	28.849	28.218	28.447
15	3.006	3.315	2.590	81	16.119	16.481	15.715	146	29.048	29.416	28.608
16	3.204	3.517	2.804	82	16.318	16.681	15.918	147	29.247	29.615	28.845
17	3.401	3.718	2.987	83	16.516	16.879	16.113	148	29.446	29.814	29.046
18	3.599	3.919	3.159	84	16.715	17.079	16.315	149	29.645	30.013	29.243
19	3.798	4.121	3.384	85	16.914	17.278	16.511	150	29.844	30.213	29.444
20	3.995	4.321	3.595	86	17.113	17.476	16.713	151	30.043	30.411	29.641
21	4.194	4.522	3.782	87	17.312	17.676	16.909	152	30.241	30.610	29.841
22	4.392	4.722	3.992	88	17.511	17.874	17.111	153	30.441	30.809	30.039
23	4.590	4.923	4.179	89	17.709	18.074	17.307	154	30.639	31.008	30.239
24	4.788	5.123	4.388	90	17.909	18.273	17.509	155	30.838	31.207	30.437
25	4.987	5.323	4.577	91	18.108	18.472	17.705	156	31.038	31.406	30.638
26	5.185	5.523	4.785	92	18.306	18.671	17.906	157	31.236	31.605	30.835
27	5.384	5.723	4.975	93	18.505	18.870	18.103	158	31.435	31.804	31.035
28	5.582	5.922	5.182	94	18.704	19.069	18.304	159	31.634	32.003	31.233
29	5.781	6.122	5.371	95	18.903	19.268	18.501	160	31.833	32.202	31.433
30	5.979	6.321	5.579	96	19.102	19.467	18.702	161	32.032	32.401	31.630
31	6.178	6.521	5.770	97	19.301	19.666	18.898	162	32.231	32.600	31.831
32	6.376	6.721	5.976	98	19.500	19.865	19.100	163	32.430	32.799	32.082
33	6.575	6.921	6.168	99	19.699	20.064	19.296	164	32.629	32.998	32.229
34	6.774	7.120	6.374	100	19.898	20.263	19.498	165	32.828	33.197	32.426
35	6.973	7.319	6.565	101	20.096	20.462	19.694	166	33.027	33.396	32.627
36	7.171	7.519	6.771	102	20.296	20.661	19.896	167	33.226	33.595	32.824
37	7.370	7.718	6.963	103	20.494	20.860	20.092	168	33.424	33.794	33.024
38	7.569	7.918	7.169	104	20.693	21.059	20.293	169	33.624	33.993	33.223
39	7.768	8.117	7.361	105	20.893	21.258	20.490	170	33.823	34.192	33.423
40	7.966	8.316	7.566	106	21.091	21.457	20.691	171	34.021	34.391	33.620
41	8.165	8.516	7.759	107	21.290	21.656	20.888	172	34.220	34.589	33.820
42	8.364	8.715	7.964	108	21.489	21.855	21.089	173	34.419	34.789	34.018
43	8.563	8.914	8.157	109	21.688	22.054	21.286	174	34.618	34.988	34.218
44	8.761	9.114	8.361	110	21.887	22.253	21.487	175	34.817	35.186	34.416
45	8.960	9.313	8.554	111	22.086	22.452	21.684	176	35.016	35.386	34.616
46	9.159	9.512	8.759	112	22.284	22.651	21.884	177	35.215	35.584	34.814
47	9.358	9.711	8.952	113	22.484	22.850	22.081	178	35.414	35.783	35.014
48	9.556	9.911	9.156	114	22.683	23.049	22.283	179	35.613	35.983	35.211
49	9.755	10.110	9.350	115	22.881	23.248	22.479	180	35.812	36.181	35.412
50	9.954	10.309	9.554	116	23.080	23.447	22.680	181	36.011	36.380	35.609
51	10.153	10.508	9.748	117	23.279	23.646	22.827	182	36.209	36.579	35.809
52	10.351	10.708	9.951	118	23.478	23.845	23.078	183	36.409	36.778	36.007
53	10.550	10.907	10.146	119	23.677	24.044	23.275	184	36.608	36.977	36.208
54	10.749	11.106	10.349	120	23.876	24.243	23.476	185	36.806	37.176	36.405
55	10.948	11.305	10.543	121	24.075	24.442	23.673	186	37.005	37.375	36.605
56	11.147	11.504	10.747	122	24.274	24.641	23.874	187	37.204	37.574	36.803
57	11.346	11.703	10.941	123	24.473	24.840	24.071	188	37.403	37.773	37.003
58	11.544	11.903	11.144	124	24.672	25.039	24.272	189	37.602	37.972	37.201
59	11.743	12.102	11.339	125	24.871	25.238	24.469	190	37.801	38.171	37.401
60	11.942	12.301	11.542	126	25.069	25.437	24.669	191	38.000	38.370	37.599
61	12.141	12.500	11.737	127	25.269	25.636	24.867	192	38.199	38.569	37.799
62	12.340	12.699	11.940	128	25.468	25.834	25.068	193	38.398	38.768	37.998
63	12.539	12.898	12.135	129	25.666	26.034	25.264	194	38.597	38.967	38.197
64	12.738	13.098	12.338	130	25.865	26.233	25.465	195	38.796	39.166	38.394
65	12.936	13.296	12.533	131	26.064	26.432	25.662	196	38.994	39.364	38.594
66	13.135	13.496	12.735	132	26.263	26.631	25.863	197	39.194	39.564	38.792
67	13.334	13.694	12.930	133	26.462	26.829	26.060	198	39.393	39.763	38.993
68	13.533	13.894	13.133	134	26.661	27.029	26.261	199	39.591	39.961	39.190
69	13.732	14.093	13.328	135	26.860	27.228	26.458	200	39.791	40.161	39.391
70	13.931	14.292	13.531								

SPROCKETS



Sprocket Diameters

No. 60

3/4" Pitch

ROLLER CHAIN SPROCKET DIAMETERS

No. Teeth	Pitch Diameter	Outside Diameter	Caliper Diameter	No. Teeth	Pitch Diameter	Outside Diameter	Caliper Diameter	No. Teeth	Pitch Diameter	Outside Diameter	Caliper Diameter
5	1.276	1.482	.745	71	16.955	17.389	16.482	136	32.471	32.912	32.002
6	1.500	1.749	1.031	72	17.195	17.628	16.726	137	32.709	33.151	32.238
7	1.729	2.007	1.216	73	17.433	17.867	16.960	138	32.948	33.389	32.479
8	1.960	2.261	1.491	74	17.672	18.106	17.203	139	33.187	33.629	32.716
9	2.193	2.511	1.691	75	17.910	18.344	17.437	140	33.425	33.867	32.956
10	2.427	2.759	1.958	76	18.149	18.584	17.680	141	33.664	34.106	33.193
11	2.663	3.005	2.166	77	18.388	18.822	17.915	142	33.903	34.345	33.434
12	2.898	3.249	2.429	78	18.626	19.061	18.157	143	34.142	34.583	33.670
13	3.134	3.493	2.642	79	18.865	19.300	18.392	144	34.380	34.822	33.911
14	3.371	3.736	2.902	80	19.103	19.539	18.634	145	34.619	35.061	34.148
15	3.608	3.978	3.119	81	19.343	19.778	18.870	146	34.858	35.300	34.389
16	3.845	4.220	3.380	82	19.581	20.017	19.112	147	35.096	35.538	34.625
17	4.082	4.462	3.595	83	19.820	20.255	19.347	148	35.335	35.777	34.866
18	4.319	4.703	3.850	84	20.058	20.495	19.589	149	35.574	36.016	35.103
19	4.557	4.945	4.072	85	20.297	20.733	19.824	150	35.813	36.255	35.344
20	4.794	5.186	4.325	86	20.536	20.972	20.067	151	36.051	36.494	35.580
21	5.033	5.426	4.549	87	20.774	21.211	20.302	152	36.309	36.732	35.821
22	5.270	5.666	4.801	88	21.013	21.449	20.544	153	36.529	36.971	36.058
23	5.508	5.907	5.026	89	21.251	21.689	20.779	154	36.767	37.210	36.298
24	5.746	6.147	5.277	90	21.491	21.927	21.022	155	37.006	37.448	36.535
25	5.984	6.387	5.503	91	21.729	22.166	21.257	156	37.245	37.688	36.776
26	6.222	6.627	5.753	92	21.968	22.405	21.499	157	37.484	37.926	37.013
27	6.461	6.867	5.980	93	22.206	22.644	21.734	158	37.722	38.165	37.253
28	6.698	7.106	6.229	94	22.445	22.883	21.976	159	37.961	38.404	37.490
29	6.937	7.346	6.458	95	22.684	23.121	22.212	160	38.200	38.642	37.731
30	7.175	7.586	6.706	96	22.922	23.360	22.453	161	38.438	38.881	37.968
31	7.413	7.826	6.935	97	23.162	23.599	22.689	162	38.677	39.120	38.208
32	7.652	8.065	7.183	98	23.400	23.838	22.931	163	38.916	39.359	38.445
33	7.890	8.305	7.412	99	23.639	24.077	23.167	164	39.155	39.597	38.686
34	8.129	8.544	7.660	100	23.877	24.316	23.408	165	39.393	39.836	38.922
35	8.367	8.783	7.889	101	24.116	24.554	23.644	166	39.632	40.075	39.163
36	8.606	9.023	8.137	102	24.355	24.793	23.886	167	39.871	40.314	39.400
37	8.844	9.262	8.367	103	24.593	25.032	24.121	168	40.109	40.553	39.640
38	9.083	9.501	8.614	104	24.832	25.271	24.363	169	40.349	40.791	39.877
39	9.321	9.740	8.844	105	25.071	25.510	24.599	170	40.587	41.030	40.118
40	9.560	9.980	9.091	106	25.310	25.748	24.841	171	40.826	41.269	40.355
41	9.798	10.219	9.321	107	25.548	25.987	25.076	172	41.064	41.507	40.595
42	10.037	10.458	9.568	108	25.787	26.226	25.318	173	41.303	41.747	40.832
43	10.275	10.697	9.799	109	26.026	26.465	25.554	174	41.542	41.985	41.073
44	10.514	10.937	10.045	110	26.264	26.704	25.795	175	41.780	42.224	41.310
45	10.752	11.176	10.276	111	26.503	26.942	26.031	176	42.020	42.463	41.551
46	10.991	11.414	10.522	112	26.741	27.181	26.272	177	42.258	42.701	41.787
47	11.229	11.654	10.754	113	26.981	27.420	26.507	178	42.497	42.940	42.028
48	11.468	11.893	10.999	114	27.219	27.659	26.750	179	42.735	43.179	42.265
49	11.706	12.132	11.231	115	27.458	27.898	26.986	180	42.974	43.418	42.505
50	11.945	12.371	11.476	116	27.696	28.136	27.227	181	43.213	43.656	42.742
51	12.183	12.610	11.708	117	27.935	28.375	27.464	182	43.451	43.895	42.982
52	12.422	12.849	11.953	118	28.174	28.614	27.705	183	43.691	44.134	43.220
53	12.660	13.088	12.186	119	28.412	28.853	27.941	184	43.929	44.372	43.460
54	12.899	13.327	12.430	120	28.652	29.091	28.183	185	44.168	44.612	43.697
55	13.137	13.566	12.663	121	28.890	29.330	28.418	186	44.406	44.850	43.937
56	13.376	13.805	12.907	122	29.129	29.569	28.660	187	44.645	45.089	44.174
57	13.615	14.044	13.140	123	29.367	29.808	28.896	188	44.884	45.328	44.415
58	13.853	14.283	13.384	124	29.606	30.047	29.137	189	45.122	45.566	44.652
59	14.092	14.522	13.618	125	29.845	30.285	29.373	190	45.362	45.805	44.893
60	14.330	14.761	13.861	126	30.083	30.524	29.614	191	45.600	46.044	45.129
61	14.570	15.000	14.095	127	30.323	30.763	29.851	192	45.839	46.283	45.370
62	14.808	15.239	14.339	128	30.561	31.001	30.092	193	46.077	46.521	45.607
63	15.047	15.478	14.573	129	30.800	31.241	30.328	194	46.316	46.760	45.847
64	15.285	15.717	14.816	130	31.038	31.479	30.569	195	46.555	46.999	46.084
65	15.524	15.956	15.050	131	31.277	31.718	30.806	196	46.793	47.237	46.324
66	15.762	16.195	15.293	132	31.516	31.957	31.047	197	47.033	47.477	46.562
67	16.001	16.433	15.528	133	31.754	32.195	31.283	198	47.271	47.715	46.802
68	16.240	16.673	15.771	134	31.993	32.435	31.524	199	47.510	47.954	47.039
69	16.478	16.911	16.005	135	32.232	32.673	31.761	200	47.749	48.193	47.280
70	16.717	17.150	16.248								

SPROCKETS

No. 80 1" Pitch

Sprocket Diameters

ROLLER CHAIN SPROCKET DIAMETERS

No. Teeth	Pitch Diameter	Outside Diameter	Caliper Diameter	No. Teeth	Pitch Diameter	Outside Diameter	Caliper Diameter	No. Teeth	Pitch Diameter	Outside Diameter	Caliper Diameter
5	1.701	1.976	.993	71	22.607	23.185	21.977	136	43.294	43.882	42.669
6	2.000	2.332	1.375	72	22.926	23.504	22.301	137	43.612	44.201	42.984
7	2.305	2.676	1.622	73	23.244	23.822	22.613	138	43.931	44.519	43.306
8	2.613	3.014	1.988	74	23.562	24.141	22.937	139	44.249	44.838	43.621
9	2.924	3.348	2.254	75	23.880	24.459	23.250	140	44.567	45.156	43.942
10	3.236	3.678	2.611	76	24.198	24.778	23.573	141	44.885	45.474	44.258
11	3.550	4.006	2.888	77	24.517	25.096	23.887	142	45.204	45.793	44.579
12	3.864	4.332	3.239	78	24.835	25.415	24.210	143	45.522	46.111	44.894
13	4.179	4.657	3.523	79	25.153	25.733	24.523	144	45.840	46.429	45.215
14	4.494	4.981	3.869	80	25.471	26.052	24.846	145	46.158	46.748	45.531
15	4.810	5.304	4.158	81	25.790	26.370	25.160	146	46.477	47.066	45.852
16	5.126	5.627	4.501	82	26.108	26.689	25.483	147	46.795	47.384	46.167
17	5.442	5.949	4.794	83	26.426	27.007	25.796	148	47.113	47.703	46.488
18	5.759	6.271	5.134	84	26.744	27.326	26.119	149	47.432	48.021	46.804
19	6.076	6.593	5.430	85	27.062	27.644	26.433	150	47.750	48.340	47.125
20	6.392	6.914	5.767	86	27.381	27.962	26.756	151	48.068	48.658	47.441
21	6.710	7.235	6.066	87	27.699	28.281	27.069	152	48.386	48.976	47.761
22	7.027	7.555	6.402	88	28.017	28.599	27.392	153	48.705	49.295	48.077
23	7.344	7.876	6.702	89	28.335	28.918	27.706	154	49.023	49.613	48.398
24	7.661	8.196	7.036	90	28.654	29.236	28.029	155	49.341	49.931	48.714
25	7.979	8.516	7.338	91	28.972	29.555	28.343	156	49.660	50.250	49.035
26	8.296	8.836	7.671	92	29.290	29.873	28.665	157	49.978	50.568	49.351
27	8.614	9.156	7.974	93	29.608	30.192	28.979	158	50.296	50.886	49.671
28	8.931	9.475	8.306	94	29.927	30.510	29.302	159	50.615	51.205	49.987
29	9.249	9.795	8.611	95	30.245	30.828	29.616	160	50.933	51.523	50.308
30	9.567	10.114	8.942	96	30.563	31.147	29.938	161	51.251	51.841	50.624
31	9.884	10.434	9.247	97	30.882	31.465	30.252	162	51.569	52.160	50.944
32	10.202	10.753	9.577	98	31.200	31.784	30.575	163	51.888	52.478	51.260
33	10.520	11.073	9.883	99	31.518	32.102	30.889	164	52.206	52.796	51.581
34	10.838	11.392	10.213	100	31.836	32.421	31.211	165	52.524	53.115	51.897
35	11.156	11.711	10.520	101	32.154	32.739	31.526	166	52.843	53.433	52.218
36	11.471	12.030	10.849	102	32.473	33.057	31.848	167	53.161	53.752	52.533
37	11.792	12.349	11.156	103	32.791	33.376	32.162	168	53.479	54.070	52.854
38	12.110	12.668	11.485	104	33.109	33.694	32.484	169	53.798	54.388	53.170
39	12.428	12.987	11.792	105	33.428	34.013	32.799	170	54.116	54.707	53.491
40	12.746	13.306	12.121	106	33.746	34.331	33.121	171	54.434	55.025	53.807
41	13.064	13.625	12.429	107	34.064	34.649	33.435	172	54.752	55.343	54.127
42	13.382	13.944	12.757	108	34.382	34.968	33.757	173	55.071	55.662	54.443
43	13.700	14.263	13.065	109	34.701	35.286	34.072	174	55.389	55.980	54.764
44	14.018	14.582	13.393	110	35.019	35.605	34.394	175	55.707	56.298	55.080
45	14.336	14.901	13.702	111	35.337	35.923	34.709	176	56.026	56.617	55.401
46	14.654	15.219	14.029	112	35.655	36.241	35.030	177	56.344	56.935	55.717
47	14.972	15.538	14.338	113	35.974	36.560	35.345	178	56.662	57.253	56.037
48	15.290	15.857	14.665	114	36.292	36.878	35.667	179	56.980	57.572	56.353
49	15.608	16.176	14.975	115	36.610	37.197	35.982	180	57.299	57.890	56.674
50	15.926	16.495	15.301	116	36.928	37.515	36.303	181	57.617	58.208	56.990
51	16.244	16.813	15.611	117	37.274	37.833	36.618	182	57.935	58.527	57.310
52	16.562	17.132	15.937	118	37.565	38.152	36.940	183	58.254	58.845	57.626
53	16.880	17.451	16.248	119	37.883	38.470	37.255	184	58.572	59.163	57.947
54	17.198	17.769	16.573	120	38.202	38.788	37.577	185	58.890	59.482	58.263
55	17.516	18.088	16.884	121	38.520	39.107	37.892	186	59.208	59.800	58.583
56	17.835	18.407	17.210	122	38.838	39.425	38.213	187	59.527	60.118	58.900
57	18.153	18.725	17.521	123	39.156	39.744	38.528	188	59.845	60.437	59.220
58	18.471	19.044	17.846	124	39.457	40.062	38.850	189	60.163	60.755	59.536
59	18.789	19.363	18.157	125	39.793	40.380	39.165	190	60.482	61.073	59.857
60	19.107	19.681	18.482	126	40.111	40.699	39.486	191	60.800	61.392	60.173
61	19.426	20.000	18.794	127	40.430	41.017	39.801	192	61.118	61.710	60.493
62	19.744	20.318	19.119	128	40.748	41.335	40.123	193	61.436	62.028	60.809
63	20.062	20.637	19.431	129	41.066	41.654	40.438	194	61.755	62.347	61.130
64	20.380	20.956	19.755	130	41.384	41.972	40.759	195	62.073	62.665	61.447
65	20.698	21.274	20.067	131	41.703	42.291	41.075	196	62.391	62.983	61.756
66	21.016	21.593	20.391	132	42.021	42.609	41.396	197	62.710	63.302	62.083
67	21.335	21.911	20.704	133	42.339	42.927	41.711	198	63.028	63.620	62.403
68	21.653	22.230	21.028	134	42.657	43.246	42.032	199	63.346	63.938	62.719
69	21.971	22.548	21.340	135	42.976	43.564	42.348	200	63.665	64.257	63.040
70	22.289	22.867	21.664								

SPROCKETS



Sprocket Diameters

No. 100 1¼" Pitch

ROLLER CHAIN SPROCKET DIAMETERS

No. Teeth	Pitch Diameter	Outside Diameter	Caliper Diameter	No. Teeth	Pitch Diameter	Outside Diameter	Caliper Diameter	No. Teeth	Pitch Diameter	Outside Diameter	Caliper Diameter
5	2.126	2.470	1.273	71	28.259	28.981	27.502	136	54.118	54.853	53.368
6	2.500	2.915	1.750	72	28.658	29.380	27.908	137	54.515	55.251	53.762
7	2.881	3.345	2.059	73	29.055	29.778	28.298	138	54.914	55.649	54.164
8	3.266	3.768	2.516	74	29.453	30.176	28.703	139	55.311	56.048	54.558
9	3.655	4.185	2.849	75	29.850	30.574	29.094	140	55.709	56.445	54.959
10	4.045	4.598	3.295	76	30.248	30.973	29.498	141	56.106	56.843	55.353
11	4.438	5.008	3.639	77	30.646	31.370	29.890	142	56.505	57.241	55.755
12	4.830	5.415	4.080	78	31.044	31.769	30.294	143	56.903	57.639	56.149
13	5.224	5.821	4.435	79	31.441	32.166	30.685	144	57.300	58.036	56.550
14	5.618	6.226	4.868	80	31.839	32.565	31.089	145	57.698	58.435	56.945
15	6.013	6.630	5.229	81	32.238	32.963	31.481	146	58.096	58.833	57.346
16	6.408	7.034	5.658	82	32.635	33.361	31.885	147	58.494	59.230	57.741
17	6.803	7.436	6.024	83	33.033	33.759	32.277	148	58.891	59.629	58.141
18	7.199	7.839	6.449	84	33.430	34.158	32.680	149	59.290	60.026	58.536
19	7.595	8.241	6.819	85	33.828	34.555	33.072	150	59.688	60.425	58.938
20	7.990	8.643	7.240	86	34.226	34.953	33.476	151	60.085	60.823	59.332
21	8.388	9.044	7.613	87	34.624	35.351	33.868	152	60.483	61.220	59.733
22	8.784	9.444	8.034	88	35.134	35.749	34.384	153	60.881	61.619	60.128
23	9.180	9.845	8.409	89	35.419	36.148	34.664	154	61.279	62.016	60.529
24	9.576	10.245	8.827	90	35.818	36.545	35.068	155	61.676	62.414	60.924
25	9.974	10.645	9.204	91	36.215	36.944	35.460	156	62.075	62.813	61.325
26	10.370	11.045	9.620	92	36.613	37.341	35.863	157	62.473	63.210	61.719
27	10.768	11.445	9.999	93	37.010	37.740	36.255	158	62.870	63.608	62.120
28	11.164	11.844	10.414	94	37.409	38.138	36.659	159	63.269	64.006	62.515
29	11.561	12.244	10.794	95	37.806	38.535	37.051	160	63.666	64.404	62.916
30	11.959	12.643	11.209	96	38.204	38.934	37.454	161	64.064	64.801	63.311
31	12.355	13.043	11.590	97	38.603	39.331	37.847	162	64.461	65.200	63.711
32	12.753	13.441	12.003	98	39.000	39.730	38.250	163	64.860	65.598	64.107
33	13.150	13.841	12.385	99	39.398	40.128	38.643	164	65.258	65.995	64.508
34	13.548	14.240	12.798	100	39.795	40.526	39.045	165	65.655	66.394	64.902
35	13.945	14.639	13.181	101	40.193	40.924	39.438	166	66.054	66.791	65.304
36	14.343	15.038	13.593	102	40.591	41.321	39.841	167	66.451	67.190	65.698
37	14.740	15.436	13.976	103	40.989	41.720	40.234	168	66.849	67.588	66.099
38	15.138	15.835	14.388	104	41.386	42.118	40.636	169	67.248	67.985	66.494
39	15.535	16.234	14.772	105	41.785	42.516	41.030	170	67.645	68.384	66.895
40	15.933	16.633	15.183	106	42.183	42.914	41.433	171	68.043	68.781	67.290
41	16.330	17.031	15.567	107	42.580	43.311	41.826	172	68.440	69.179	67.690
42	16.728	17.430	15.978	108	42.978	43.710	42.228	173	68.839	69.578	68.086
43	17.125	17.829	16.363	109	43.376	44.108	42.621	174	69.236	69.975	68.486
44	17.523	18.228	16.773	110	43.774	44.506	43.024	175	69.634	70.373	68.881
45	17.920	18.626	17.159	111	44.171	44.904	43.420	176	70.033	70.771	69.283
46	18.318	19.024	17.568	112	44.569	45.301	43.819	177	70.430	71.169	69.677
47	18.715	19.423	17.954	113	44.968	45.700	44.213	178	70.828	71.566	70.078
48	19.113	19.821	18.363	114	45.365	46.098	44.615	179	71.225	71.965	70.473
49	19.510	20.220	18.750	115	45.763	46.496	45.009	180	71.624	72.363	70.874
50	19.908	20.619	19.158	116	46.160	46.894	45.410	181	72.021	72.760	71.269
51	20.305	21.016	19.546	117	46.559	47.291	45.804	182	72.419	73.159	71.669
52	20.703	21.415	19.953	118	46.956	47.690	46.206	183	72.818	73.556	72.064
53	21.100	21.814	20.341	119	47.354	48.088	46.600	184	73.215	73.954	72.465
54	21.498	22.211	20.748	120	47.753	48.485	47.003	185	73.613	74.353	72.860
55	21.895	22.610	21.137	121	48.150	48.884	47.396	186	74.010	74.750	73.260
56	22.294	23.009	21.544	122	48.548	49.281	47.798	187	74.409	75.148	73.656
57	22.691	23.406	21.932	123	48.945	49.680	48.192	188	74.806	75.546	74.056
58	23.089	23.805	22.339	124	49.344	50.078	48.594	189	75.204	75.944	74.452
59	23.486	24.204	22.728	125	49.741	50.475	48.987	190	75.603	76.341	74.853
60	23.884	24.601	23.134	126	50.139	50.874	49.389	191	76.000	76.740	75.247
61	24.283	25.000	23.524	127	50.538	51.271	49.783	192	76.398	77.138	75.648
62	24.680	25.398	23.930	128	50.935	51.669	50.185	193	76.795	77.535	76.043
63	25.078	25.796	24.320	129	51.333	52.068	50.579	194	77.194	77.934	76.444
64	25.475	26.195	24.725	130	51.730	52.465	50.980	195	77.591	78.331	76.839
65	25.873	26.593	25.115	131	52.129	52.864	51.375	196	77.989	78.729	77.239
66	26.270	26.991	25.520	132	52.526	53.261	51.776	197	78.388	79.128	77.635
67	26.669	27.389	25.911	133	52.924	53.659	52.170	198	78.785	79.525	78.035
68	27.066	27.788	26.316	134	53.321	54.058	52.571	199	79.183	79.923	78.430
69	27.464	28.185	26.707	135	53.720	54.455	52.966	200	79.581	80.321	78.831
70	27.861	28.584	27.111								

SPROCKETS

No. 120

1½" Pitch

Sprocket Diameters



ROLLER CHAIN SPROCKET DIAMETERS

No. Teeth	Pitch Diameter	Outside Diameter	Caliper Diameter	No. Teeth	Pitch Diameter	Outside Diameter	Caliper Diameter	No. Teeth	Pitch Diameter	Outside Diameter	Caliper Diameter
5	2.552	2.964	1.552	71	33.911	34.778	33.028	136	64.941	65.823	64.066
6	3.000	3.498	2.125	72	34.389	35.256	33.514	137	65.418	66.302	64.539
7	3.458	4.014	2.496	73	34.866	35.733	33.983	138	65.897	66.779	65.022
8	3.920	4.521	3.045	74	35.343	36.212	34.468	139	66.374	67.257	65.494
9	4.386	5.022	3.444	75	35.820	36.689	34.938	140	66.851	67.734	65.976
10	4.854	5.517	3.979	76	36.297	37.167	35.422	141	67.328	68.211	66.449
11	5.325	6.009	4.392	77	36.776	37.644	35.892	142	67.806	68.690	66.931
12	5.796	6.498	4.921	78	37.253	38.123	36.378	143	68.283	69.167	67.404
13	6.269	6.986	5.347	79	37.730	38.600	36.847	144	68.760	69.644	67.885
14	6.741	7.472	5.866	80	38.207	39.078	37.332	145	69.237	70.122	68.359
15	7.215	7.956	6.300	81	38.685	39.555	37.802	146	69.716	70.599	68.841
16	7.689	8.441	6.814	82	39.162	40.034	38.287	147	70.193	71.076	69.314
17	8.163	8.924	7.254	83	39.639	40.511	38.757	148	70.670	71.555	69.795
18	8.639	9.407	7.764	84	40.116	40.989	39.241	149	71.148	72.032	70.269
19	9.114	9.890	8.207	85	40.593	41.466	39.712	150	71.625	72.510	70.750
20	9.588	10.371	8.713	86	41.072	41.943	40.197	151	72.102	72.987	71.224
21	10.065	10.853	9.161	87	41.549	42.422	40.667	152	72.579	73.464	71.704
22	10.541	11.333	9.666	88	42.026	42.899	41.151	153	73.058	73.943	72.178
23	11.016	11.814	10.115	89	42.503	43.377	41.622	154	73.535	74.420	72.660
24	11.492	12.294	10.617	90	42.981	43.854	42.106	155	74.012	74.897	73.133
25	11.969	12.774	11.070	91	43.458	44.333	42.576	156	74.490	75.375	73.615
26	12.444	13.254	11.569	92	43.935	44.810	43.060	157	74.967	75.852	74.088
27	12.921	13.734	12.024	93	44.412	45.288	43.531	158	75.444	76.329	74.569
28	13.397	14.213	12.522	94	44.891	45.765	44.016	159	75.923	76.808	75.043
29	13.874	14.693	12.978	95	45.368	46.242	44.48	160	76.400	77.285	75.525
30	14.351	15.171	13.476	96	45.845	46.721	44.970	161	76.877	77.762	75.998
31	14.826	15.651	13.933	97	46.323	47.198	45.441	162	77.354	78.240	76.479
32	15.303	16.130	14.428	98	46.800	47.676	45.925	163	77.832	78.717	76.953
33	15.780	16.610	14.887	99	47.277	48.153	46.396	164	78.309	79.194	77.434
34	16.257	17.088	15.382	100	47.754	48.632	46.879	165	78.786	79.673	77.908
35	16.734	17.567	15.842	101	48.231	49.109	47.351	166	79.265	80.150	78.390
36	17.211	18.045	16.336	102	48.710	49.586	47.835	167	79.742	80.628	78.863
37	17.688	18.524	16.797	103	49.187	50.064	48.306	168	80.219	81.105	79.344
38	18.165	19.002	17.290	104	49.664	50.541	48.789	169	80.697	81.582	79.818
39	18.642	19.481	17.751	105	50.142	51.020	49.261	170	81.174	82.061	80.299
40	19.119	19.959	18.244	106	50.619	51.497	49.744	171	81.651	82.538	80.773
41	19.596	20.438	18.706	107	51.096	51.974	50.216	172	82.128	83.015	81.253
42	20.073	20.916	19.198	108	51.573	52.452	50.698	173	82.607	83.493	81.728
43	20.550	21.395	19.661	109	52.052	52.929	51.171	174	83.084	83.970	82.209
44	21.027	21.873	20.152	110	52.529	53.408	51.654	175	83.561	84.447	82.683
45	21.504	22.352	20.615	111	53.006	53.885	52.125	176	84.039	84.926	83.164
46	21.981	22.829	21.106	112	53.483	54.362	52.608	177	84.501	85.403	83.637
47	22.458	23.307	21.570	113	53.961	54.840	53.080	178	84.993	85.880	84.118
48	22.935	23.786	22.060	114	54.438	55.317	53.563	179	85.470	86.358	84.592
49	23.412	24.264	22.525	115	54.915	55.796	54.035	180	85.949	86.835	85.074
50	23.889	24.743	23.014	116	55.392	56.273	54.517	181	86.426	87.312	85.547
51	24.366	25.220	23.480	117	55.871	56.750	54.990	182	86.903	87.791	86.028
52	24.843	25.698	23.968	118	56.348	57.228	55.473	183	87.381	88.268	86.502
53	25.320	26.177	24.434	119	56.825	57.705	55.945	184	87.858	88.745	86.983
54	25.797	26.654	24.922	120	57.303	58.182	56.428	185	88.335	89.223	87.457
55	26.274	27.132	25.389	121	57.780	58.661	56.900	186	88.812	89.700	87.937
56	26.753	27.611	25.878	122	58.257	59.138	57.382	187	89.291	90.177	88.412
57	27.230	28.088	26.344	123	58.734	59.616	57.855	188	89.768	90.656	88.893
58	27.707	28.566	26.832	124	59.213	60.093	58.338	189	90.245	91.133	89.367
59	28.184	29.045	27.299	125	59.690	60.570	58.810	190	90.723	91.610	89.848
60	28.661	29.522	27.786	126	60.167	61.049	59.292	191	91.200	92.088	90.322
61	29.139	30.000	28.254	127	60.645	61.526	59.765	192	91.677	92.565	90.802
62	29.616	30.477	28.741	128	61.122	62.003	60.247	193	92.154	93.042	91.277
63	30.093	30.956	29.208	129	61.599	62.481	60.720	194	92.633	93.521	91.758
64	30.570	31.434	29.695	130	62.076	62.958	61.201	195	93.110	93.998	92.232
65	31.047	31.911	30.163	131	62.555	63.437	61.674	196	93.587	94.475	92.712
66	31.524	32.390	30.649	132	63.032	63.914	62.157	197	94.065	94.953	93.187
67	32.003	32.867	31.118	133	63.509	64.391	62.629	198	94.542	95.430	93.667
68	32.480	33.345	31.605	134	63.986	64.869	63.111	199	95.019	95.907	94.141
69	32.957	33.822	32.073	135	64.464	65.346	63.584	200	95.498	96.386	94.623
70	33.434	34.301	32.559								

SPROCKETS



Sprocket Diameters

No. 140

1³/₄" Pitch

ROLLER CHAIN SPROCKET DIAMETERS

No. Teeth	Pitch Diameter	Outside Diameter	Caliper Diameter	No. Teeth	Pitch Diameter	Outside Diameter	Caliper Diameter	No. Teeth	Pitch Diameter	Outside Diameter	Caliper Diameter
5	2.977	3.458	1.832	71	39.562	40.574	38.553	136	75.765	76.794	74.765
6	3.500	4.081	2.500	72	40.121	41.132	39.121	137	76.321	77.352	75.316
7	4.034	4.683	2.932	73	40.677	41.689	39.667	138	76.879	77.908	75.879
8	4.573	5.275	3.573	74	41.234	42.247	40.234	139	77.436	78.467	76.431
9	5.117	5.859	4.039	75	41.790	42.803	40.781	140	78.008	79.023	77.008
10	5.663	6.437	4.663	76	42.347	43.362	41.347	141	78.549	79.580	77.545
11	6.213	7.011	5.148	77	42.905	43.918	41.895	142	79.107	80.138	78.107
12	6.762	7.581	5.762	78	43.461	44.476	42.461	143	79.664	80.694	78.484
13	7.313	8.150	6.259	79	44.018	45.033	43.009	144	80.220	81.251	79.220
14	7.865	8.717	6.865	80	44.574	45.591	43.574	145	80.777	81.809	79.773
15	8.418	9.282	7.371	81	45.133	46.148	44.123	146	81.335	82.366	80.335
16	8.971	9.847	7.971	82	45.689	46.706	44.689	147	81.891	82.922	80.887
17	9.524	10.411	8.483	83	46.246	47.262	45.237	148	82.448	83.480	81.448
18	10.078	10.974	9.078	84	46.802	47.821	45.802	149	83.006	84.037	82.000
19	10.633	11.538	9.596	85	47.359	48.377	46.351	150	83.563	84.595	82.563
20	11.186	12.100	10.186	86	47.917	48.934	46.917	151	84.119	85.152	83.115
21	11.743	12.661	10.709	87	48.473	49.492	47.465	152	84.676	85.708	83.676
22	12.297	13.221	11.297	88	49.030	50.048	48.030	153	85.234	86.266	84.229
23	12.852	13.783	11.822	89	49.586	50.607	48.579	154	85.790	86.823	84.790
24	13.407	14.343	12.407	90	50.145	51.163	49.145	155	86.347	87.379	85.343
25	13.963	14.903	12.935	91	50.701	51.721	49.693	156	86.905	87.938	85.905
26	14.518	15.463	13.518	92	51.258	52.278	50.258	157	87.462	88.494	86.457
27	15.075	16.023	14.049	93	51.814	52.836	50.807	158	88.018	89.051	87.018
28	15.629	16.581	14.629	94	52.372	53.393	51.372	159	88.576	89.609	87.571
29	16.186	17.141	15.162	95	52.929	53.949	51.921	160	89.133	90.165	88.133
30	16.742	17.700	15.742	96	53.485	54.507	52.485	161	89.689	90.722	88.685
31	17.297	18.260	16.276	97	54.044	55.064	53.035	162	90.246	91.280	89.246
32	17.854	18.818	16.854	98	54.600	55.622	53.600	163	90.804	91.837	89.799
33	18.410	19.378	17.389	99	55.157	56.179	54.150	164	91.361	92.393	90.361
34	18.967	19.936	17.967	100	55.713	56.737	54.713	165	91.917	92.951	90.913
35	19.523	20.494	18.503	101	56.270	57.293	55.264	166	92.475	93.508	91.475
36	20.080	21.053	19.080	102	56.828	57.850	55.828	167	93.032	94.066	92.027
37	20.636	21.611	19.617	103	57.384	58.408	56.378	168	93.588	94.623	92.588
38	21.193	22.169	20.193	104	57.941	58.965	56.941	169	94.147	95.179	93.141
39	21.749	22.727	20.730	105	58.499	59.523	57.492	170	94.703	95.737	93.703
40	22.306	23.286	21.306	106	59.056	60.079	58.056	171	95.260	96.294	94.255
41	22.862	23.844	21.844	107	59.612	60.636	58.606	172	95.816	96.850	94.816
42	23.419	24.402	22.419	108	60.169	61.194	59.169	173	96.374	97.409	95.370
43	23.975	24.960	22.958	109	60.727	61.751	59.720	174	96.931	97.965	95.931
44	24.532	25.519	23.532	110	61.283	62.309	60.283	175	97.487	98.522	96.484
45	25.088	26.077	24.072	111	61.840	62.865	60.834	176	98.046	99.080	97.046
46	25.645	26.633	24.645	112	62.396	63.422	61.396	177	98.602	99.636	97.598
47	26.201	27.192	25.186	113	62.955	63.980	61.948	178	99.159	100.193	98.159
48	26.758	27.750	25.758	114	63.511	64.537	62.511	179	99.715	100.751	98.712
49	27.314	28.308	26.300	115	64.068	65.095	63.062	180	100.273	101.308	99.273
50	27.871	28.866	26.871	116	64.624	65.651	63.624	181	100.830	101.864	99.826
51	28.427	29.423	27.414	117	65.182	66.208	64.176	182	101.386	102.422	100.386
52	28.984	29.981	27.984	118	65.739	66.766	64.739	183	101.945	102.979	100.940
53	29.540	30.539	28.528	119	66.295	67.323	65.290	184	102.501	103.535	101.501
54	30.097	31.096	29.097	120	66.854	67.879	65.854	185	103.058	104.094	102.054
55	30.653	31.654	29.641	121	67.410	68.437	66.404	186	103.614	104.650	102.614
56	31.211	32.212	30.211	122	67.967	68.994	66.967	187	104.172	105.207	103.168
57	31.768	32.769	30.755	123	68.523	69.552	67.518	188	104.729	105.765	103.729
58	32.324	33.327	31.324	124	69.081	70.109	68.081	189	105.285	106.321	104.282
59	32.881	33.885	31.869	125	69.638	70.665	68.632	190	105.844	106.878	104.844
60	33.437	34.442	32.437	126	70.194	71.223	69.194	191	106.400	107.436	105.396
61	33.996	35.000	32.983	127	70.753	71.780	69.746	192	106.957	107.993	105.957
62	34.552	35.557	33.552	128	71.309	72.336	70.309	193	107.513	108.549	106.510
63	35.109	36.115	34.097	129	71.866	72.893	70.860	194	108.071	109.107	107.071
64	35.665	36.673	34.665	130	72.422	73.451	71.422	195	108.628	109.664	107.624
65	36.222	37.230	35.211	131	72.980	74.009	71.974	196	109.184	110.220	108.184
66	36.778	37.788	35.778	132	73.537	74.566	72.537	197	109.743	110.779	108.738
67	37.336	38.344	36.325	133	74.093	75.122	73.088	198	110.299	111.335	109.299
68	37.893	38.903	36.893	134	74.650	75.681	73.650	199	110.856	111.892	109.853
69	38.449	39.459	37.439	135	75.208	76.237	74.202	200	111.414	112.450	110.414
70	39.006	40.017	38.006								

SPROCKETS

No. 160

2" Pitch

Sprocket Diameters

Martin

ROLLER CHAIN SPROCKET DIAMETERS

No. Teeth	Pitch Diameter	Outside Diameter	Caliper Diameter	No. Teeth	Pitch Diameter	Outside Diameter	Caliper Diameter	No. Teeth	Pitch Diameter	Outside Diameter	Caliper Diameter
5	3.402	3.952	2.111	71	45.214	46.370	44.079	136	86.588	87.764	85.463
6	4.000	4.664	2.875	72	45.852	47.008	44.727	137	87.224	88.402	86.094
7	4.610	5.352	3.369	73	46.488	47.644	45.352	138	87.862	89.038	86.737
8	5.226	6.028	4.101	74	47.124	48.282	45.999	139	88.498	89.676	87.367
9	5.848	6.696	4.635	75	47.760	48.918	46.625	140	89.134	90.312	88.009
10	6.472	7.356	5.347	76	48.396	49.556	47.271	141	89.770	90.948	88.640
11	7.100	8.012	5.902	77	49.034	50.192	47.898	142	90.408	91.586	89.283
12	7.728	8.664	6.603	78	49.670	50.830	48.545	143	91.044	92.222	89.913
13	8.358	9.314	7.171	79	50.306	51.466	49.171	144	91.680	92.858	90.555
14	8.988	9.962	7.863	80	50.942	52.104	49.817	145	92.316	93.496	91.187
15	9.620	10.608	8.442	81	51.580	52.740	50.444	146	92.945	94.132	91.829
16	10.252	11.254	9.127	82	52.216	53.378	51.091	147	93.590	94.768	92.460
17	10.844	11.898	9.713	83	52.852	54.014	51.718	148	94.226	95.406	93.101
18	11.518	12.542	10.393	84	53.488	54.652	52.363	149	94.864	96.042	93.733
19	12.152	13.186	10.985	85	54.124	55.288	52.991	150	95.500	96.680	94.375
20	12.784	13.828	11.659	86	54.762	55.924	53.637	151	96.136	97.316	95.006
21	13.420	14.470	12.256	87	55.398	56.562	54.264	152	96.772	97.952	95.647
22	14.054	15.110	12.929	88	56.034	57.198	54.909	153	97.410	98.590	96.280
23	14.688	15.752	13.529	89	56.670	57.836	55.537	154	98.046	99.226	96.921
24	15.322	16.392	14.197	90	57.308	58.472	56.183	155	98.682	99.862	97.553
25	15.958	17.032	14.801	91	57.944	59.110	56.810	156	99.320	100.500	98.195
26	16.592	17.672	15.467	92	58.580	59.746	57.455	157	99.956	101.136	98.826
27	17.228	18.312	16.073	93	59.216	60.384	58.083	158	100.592	101.772	99.467
28	17.862	18.950	16.737	94	59.854	61.020	58.729	159	101.230	102.410	100.099
29	18.498	19.590	17.346	95	60.490	61.656	59.357	160	101.866	103.046	100.741
30	19.134	20.228	18.009	96	61.126	62.294	60.001	161	102.502	103.682	101.372
31	19.768	20.868	18.619	97	61.764	62.930	60.630	162	103.138	104.320	102.013
32	20.404	21.506	19.279	98	62.400	63.568	61.275	163	103.776	104.956	102.646
33	21.040	22.146	19.891	99	63.036	64.204	61.903	164	104.412	105.592	103.287
34	21.676	22.784	20.551	100	63.672	64.842	62.547	165	105.048	106.230	103.919
35	22.312	23.422	21.164	101	64.308	65.478	63.176	166	105.686	106.866	104.561
36	22.948	24.060	21.823	102	64.946	66.114	63.821	167	106.322	107.504	105.192
37	23.584	24.698	22.437	103	65.582	66.752	64.449	168	106.958	108.140	105.833
38	24.220	25.336	23.095	104	66.218	67.388	65.093	169	107.596	108.776	106.465
39	24.856	25.974	23.710	105	66.856	68.026	65.723	170	108.232	109.414	107.107
40	25.492	26.612	24.367	106	67.492	68.662	66.367	171	108.868	110.050	107.738
41	26.128	27.250	24.983	107	68.128	69.298	66.996	172	109.504	110.686	108.379
42	26.764	27.888	25.639	108	68.764	69.936	67.639	173	110.142	111.324	109.012
43	27.400	28.526	26.256	109	69.400	70.572	68.269	174	110.778	111.960	109.653
44	28.036	29.164	26.911	110	70.038	70.210	68.913	175	111.414	112.596	110.285
45	28.672	29.802	27.529	111	70.674	71.846	69.542	176	112.052	113.234	110.927
46	29.308	30.438	28.183	112	71.310	72.482	70.185	177	112.688	113.870	111.558
47	29.944	31.076	28.802	113	71.948	73.120	70.815	178	113.324	114.506	112.199
48	30.580	31.714	29.455	114	72.584	73.756	71.459	179	113.960	115.144	112.831
49	31.216	32.352	30.075	115	73.220	74.394	72.089	180	114.598	115.780	113.473
50	31.852	32.990	30.727	116	73.856	75.030	72.731	181	115.234	116.416	114.105
51	32.488	33.626	31.348	117	74.494	75.666	73.362	182	115.870	117.054	114.745
52	33.124	34.264	31.999	118	75.130	76.304	74.005	183	116.508	117.690	115.388
53	33.760	34.902	32.621	119	75.766	76.940	74.645	184	117.144	118.326	116.019
54	34.396	35.538	33.271	120	76.404	77.576	75.279	185	117.780	118.964	116.651
55	35.032	36.176	33.894	121	77.040	78.214	75.908	186	118.416	119.600	117.291
56	35.670	36.814	34.545	122	77.676	78.850	76.551	187	119.054	120.236	117.924
57	36.306	37.450	35.167	123	78.312	79.488	77.181	188	119.690	120.874	118.565
58	36.942	38.088	35.817	124	78.950	80.124	77.825	189	120.326	121.510	119.197
59	37.578	38.726	36.440	125	79.586	80.760	78.455	190	120.964	122.146	119.839
60	38.214	39.362	37.089	126	80.222	81.398	79.097	191	121.600	122.784	120.471
61	38.852	40.000	37.713	127	80.860	82.034	79.728	192	122.236	123.420	121.111
62	39.488	40.636	38.363	128	81.496	82.670	80.371	193	122.872	124.056	121.744
63	40.124	41.274	38.986	129	82.132	83.308	81.001	194	123.510	124.694	122.385
64	40.760	41.912	39.635	130	82.768	83.944	81.643	195	124.146	125.330	123.017
65	41.396	42.548	40.259	131	83.406	84.582	82.274	196	124.781	125.966	123.656
66	42.032	43.186	40.907	132	84.042	85.218	82.917	197	125.420	126.604	124.290
67	42.670	43.822	41.532	133	84.678	85.854	83.547	198	126.056	127.240	124.931
68	43.306	44.460	42.181	134	85.314	86.492	84.189	199	126.692	127.876	125.564
69	43.942	45.096	42.806	135	85.952	87.128	84.820	200	127.330	128.514	126.205
70	44.578	45.734	43.453								

SPROCKETS



Sprocket Diameters

No. 180 2 1/4" Pitch

ROLLER CHAIN SPROCKET DIAMETERS

No. Teeth	Pitch Diameter	Outside Diameter	Caliper Diameter	No. Teeth	Pitch Diameter	Outside Diameter	Caliper Diameter	No. Teeth	Pitch Diameter	Outside Diameter	Caliper Diameter
5	3.828	4.446	2.234	71	50.866	52.166	49.448	136	97.412	98.735	96.006
6	4.500	5.247	3.094	72	51.583	52.884	50.177	137	98.128	99.452	96.715
7	5.186	6.021	3.650	73	52.299	53.600	50.880	138	98.844	100.166	97.438
8	5.879	6.782	4.473	74	53.015	54.317	51.609	139	99.560	100.886	98.148
9	6.579	7.533	5.073	75	53.730	55.033	52.313	140	100.276	101.601	98.870
10	7.281	8.276	5.875	76	54.446	55.751	53.040	141	100.992	102.317	99.580
11	7.986	9.014	6.499	77	55.162	56.466	53.745	142	101.708	103.034	100.302
12	8.693	9.747	7.287	78	55.879	57.184	54.473	143	102.425	103.750	101.012
13	9.402	10.478	7.927	79	56.594	57.899	55.177	144	103.140	104.465	101.734
14	10.112	11.207	8.706	80	57.310	58.617	55.904	145	103.857	105.183	102.445
15	10.822	11.934	9.357	81	58.027	59.333	56.610	146	104.573	105.899	103.167
16	11.533	12.661	10.127	82	58.743	60.055	57.337	147	105.289	106.614	103.877
17	12.245	13.385	10.787	83	59.459	60.766	58.042	148	106.005	108.332	104.599
18	12.957	14.110	11.551	84	60.175	61.484	58.769	149	106.721	108.047	105.309
19	13.670	14.834	12.217	85	60.891	62.199	59.474	150	107.438	108.765	106.032
20	14.383	15.557	12.977	86	61.607	62.915	60.201	151	108.154	109.481	106.742
21	15.096	16.279	13.648	87	62.323	63.632	60.907	152	108.870	110.196	107.464
22	15.810	16.999	14.404	88	63.039	63.348	61.633	153	109.586	110.914	108.174
23	16.524	17.721	15.079	89	63.755	65.066	62.339	154	110.302	111.629	108.896
24	17.238	18.441	15.832	90	64.471	65.781	63.065	155	111.018	112.345	109.607
25	17.952	19.161	16.511	91	65.187	66.499	63.771	156	111.734	113.063	110.328
26	18.666	19.881	17.260	92	65.903	67.214	64.497	157	112.451	113.778	111.039
27	19.381	20.601	17.942	93	66.619	67.932	65.203	158	113.167	114.494	111.761
28	20.096	21.319	18.690	94	67.335	68.648	65.929	159	113.883	115.211	112.471
29	20.810	22.039	19.374	95	68.051	69.363	66.636	160	114.599	115.927	113.193
30	21.525	22.757	20.119	96	68.767	70.081	67.361	161	115.315	116.642	113.904
31	22.240	23.477	20.806	97	69.483	70.796	68.068	162	116.031	117.360	114.625
32	22.955	24.194	21.549	98	70.199	71.514	68.793	163	116.747	118.076	115.336
33	23.670	24.914	22.237	99	70.916	72.230	69.500	164	117.464	118.791	116.058
34	24.385	25.632	22.979	100	71.631	72.947	70.225	165	118.180	119.509	116.768
35	25.101	26.350	23.669	101	72.348	73.663	70.933	166	118.896	120.224	117.490
36	25.816	27.068	24.410	102	73.064	74.378	71.658	167	119.612	120.942	118.201
37	26.531	27.785	25.101	103	73.780	75.096	72.365	168	120.328	121.658	118.922
38	27.246	28.503	25.840	104	74.496	75.812	73.090	169	121.044	122.373	119.633
39	27.962	29.221	26.533	105	75.212	76.529	73.798	170	121.760	123.091	120.354
40	28.677	29.939	27.271	106	75.928	77.245	74.522	171	122.477	123.806	121.065
41	29.393	30.656	27.965	107	76.644	77.960	75.230	172	123.193	124.522	121.787
42	30.108	31.374	28.702	108	77.360	78.678	75.954	173	123.909	125.240	122.498
43	30.824	32.092	29.397	109	78.073	79.394	76.662	174	124.625	125.955	123.219
44	31.539	32.810	30.133	110	78.792	80.111	77.386	175	125.341	126.671	123.930
45	32.255	33.527	30.830	111	79.508	80.827	78.095	176	126.057	127.388	124.651
46	32.971	34.243	31.565	112	80.225	81.542	78.819	177	126.774	128.104	125.363
47	33.686	34.961	32.262	113	80.931	82.260	79.527	178	127.490	128.819	126.084
48	34.402	35.678	32.996	114	81.657	82.976	80.251	179	128.206	129.537	126.795
49	35.118	36.396	33.694	115	82.373	83.693	80.959	180	128.922	130.253	127.516
50	35.834	37.114	34.428	116	83.089	84.409	81.683	181	129.638	130.968	128.227
51	36.549	37.829	35.126	117	83.805	85.124	82.392	182	130.354	131.686	128.948
52	37.265	38.547	35.859	118	84.521	85.842	83.115	183	131.071	132.401	129.660
53	37.981	39.265	36.558	119	85.237	86.558	83.824	184	131.787	133.117	130.381
54	38.696	39.980	37.290	120	85.953	87.273	84.547	185	132.503	133.835	131.092
55	39.412	40.698	37.990	121	86.670	87.991	85.256	186	133.219	134.550	131.813
56	40.128	41.416	38.722	122	87.386	88.706	85.980	187	133.935	135.266	132.524
57	40.844	42.131	39.422	123	88.102	89.424	86.689	188	134.651	135.983	133.245
58	41.560	42.849	40.154	124	88.818	90.140	87.412	189	135.367	136.699	133.957
59	42.276	43.567	40.855	125	89.534	90.855	88.121	190	136.084	137.414	134.678
60	42.991	44.282	41.585	126	90.250	91.573	88.844	191	136.800	138.132	135.389
61	43.707	45.000	42.287	127	90.966	92.288	89.553	192	137.516	138.848	136.110
62	44.423	45.716	43.017	128	91.682	93.004	90.276	193	138.232	139.563	136.822
63	45.139	46.433	43.719	129	92.399	93.722	90.986	194	138.948	140.281	137.542
64	45.855	47.151	44.449	130	93.115	94.437	91.709	195	139.664	140.996	138.254
65	46.571	47.867	45.151	131	93.831	95.155	92.418	196	140.381	141.712	138.975
66	47.287	48.584	45.881	132	94.547	95.870	93.141	197	141.097	142.430	139.686
67	48.003	49.300	46.584	133	95.263	96.586	93.850	198	141.813	143.145	140.407
68	48.719	50.018	47.313	134	95.979	97.304	94.573	199	142.529	143.861	141.119
69	49.435	50.733	48.016	135	96.695	98.019	95.283	200	143.245	144.578	141.839
70	50.151	51.451	48.745								

SPROCKETS

No. 200
2½" Pitch

**Sprocket
Diameters**

Martin

ROLLER CHAIN SPROCKET DIAMETERS

No. Teeth	Pitch Diameter	Outside Diameter	Caliper Diameter	No. Teeth	Pitch Diameter	Outside Diameter	Caliper Diameter	No. Teeth	Pitch Diameter	Outside Diameter	Caliper Diameter
5	4.253	4.940	2.482	71	56.518	57.962	54.942	136	108.235	109.705	106.672
6	5.000	5.830	3.438	72	57.315	58.760	55.752	137	109.030	110.502	107.461
7	5.760	6.690	4.055	73	58.110	59.555	56.533	138	109.827	111.297	108.264
8	6.533	7.535	4.970	74	58.905	60.352	57.342	139	110.622	112.095	109.052
9	7.310	8.370	5.636	75	59.700	61.147	58.125	140	111.418	112.890	109.855
10	8.090	9.195	6.527	76	60.495	61.945	58.932	141	112.212	113.685	110.644
11	8.875	10.015	7.220	77	61.292	62.740	59.716	142	113.010	114.482	111.447
12	9.660	10.830	8.097	78	62.087	63.537	60.524	143	113.805	115.277	112.235
13	10.447	11.642	8.807	79	62.882	64.332	61.307	144	114.600	116.072	113.037
14	11.235	12.452	9.672	80	63.678	65.130	62.115	145	115.395	116.870	113.827
15	12.025	13.260	10.396	81	64.475	65.925	62.899	146	116.192	117.665	114.629
16	12.815	14.068	11.252	82	65.270	66.722	63.707	147	116.988	118.460	115.418
17	13.605	14.872	11.985	83	66.065	67.517	64.490	148	117.783	119.257	116.220
18	14.397	15.678	12.834	84	66.860	68.315	65.297	149	118.580	120.052	117.010
19	15.190	16.478	13.574	85	67.655	69.110	66.082	150	119.375	120.850	117.812
20	15.980	17.285	14.417	86	68.452	69.905	66.889	151	120.170	121.645	118.601
21	16.775	18.088	15.164	87	69.247	70.702	67.673	152	120.965	122.440	119.402
22	17.567	18.888	16.004	88	70.043	71.497	68.480	153	121.762	123.237	120.193
23	18.360	19.690	16.754	89	70.838	72.295	69.265	154	122.558	124.032	120.995
24	19.153	20.490	17.590	90	71.635	73.090	70.072	155	123.354	124.827	121.784
25	19.947	21.290	18.345	91	72.430	73.887	70.856	156	124.150	125.624	122.587
26	20.740	22.090	19.177	92	73.225	74.682	71.662	157	124.945	126.420	123.376
27	21.535	22.890	19.935	93	74.020	75.480	72.448	158	125.740	127.215	124.177
28	22.327	23.688	20.764	94	74.817	76.275	73.254	159	126.537	128.012	124.967
29	23.123	24.488	21.526	95	75.612	77.070	74.039	160	127.332	128.807	125.769
30	23.917	25.285	22.354	96	76.408	77.867	74.845	161	128.127	129.602	126.559
31	24.710	26.085	23.117	97	77.205	78.662	75.631	162	128.923	130.400	127.360
32	25.505	26.882	23.942	98	78.000	79.460	76.437	163	129.720	131.195	128.150
33	26.300	27.682	24.708	99	78.795	80.255	77.222	164	130.515	131.990	128.952
34	27.095	28.480	25.532	100	79.590	81.052	78.027	165	131.310	132.787	129.742
35	27.890	29.280	26.300	101	80.385	81.847	78.814	166	132.107	133.582	130.544
36	28.685	30.075	27.122	102	81.182	82.642	79.619	167	132.903	134.380	131.333
37	29.480	30.872	27.890	103	81.977	83.440	80.405	168	133.697	135.175	132.134
38	30.275	31.670	28.712	104	82.773	84.235	81.210	169	134.495	135.970	132.925
39	31.070	32.468	29.481	105	83.570	85.032	81.997	170	135.290	136.767	133.727
40	31.865	33.265	30.302	106	84.365	85.827	82.802	171	136.085	137.562	134.516
41	32.660	34.062	31.072	107	85.160	86.622	83.588	172	136.880	138.357	135.317
42	33.455	34.860	31.892	108	85.955	87.420	84.392	173	137.677	139.155	136.108
43	34.250	35.658	32.663	109	86.753	88.215	85.180	174	138.472	139.950	136.909
44	35.045	36.455	33.482	110	87.547	89.012	85.984	175	139.268	140.745	137.700
45	35.840	37.252	34.254	111	88.342	89.808	86.771	176	140.065	141.542	138.502
46	36.635	38.047	35.072	112	89.137	90.603	87.574	177	140.860	142.329	139.291
47	37.430	38.845	35.846	113	89.935	91.400	88.363	178	141.655	143.132	140.092
48	38.225	39.642	36.662	114	90.730	92.195	89.167	179	142.450	143.930	140.883
49	39.020	40.440	37.437	115	91.525	92.992	89.954	180	143.247	144.725	141.684
50	39.815	41.238	38.252	116	92.320	93.787	90.757	181	144.042	145.520	142.474
51	40.610	42.032	39.028	117	93.117	94.582	91.546	182	144.838	146.318	143.275
52	41.405	42.830	39.842	118	93.912	95.380	92.349	183	145.635	147.113	144.066
53	42.200	43.627	40.619	119	94.707	96.175	93.137	184	146.430	147.908	144.867
54	42.995	44.422	41.432	120	95.505	96.970	93.942	185	147.225	148.705	145.657
55	43.790	45.220	42.211	121	96.300	97.767	94.729	186	148.020	149.500	146.457
56	44.587	46.018	43.024	122	97.095	98.562	95.532	187	148.817	150.295	147.249
57	45.383	46.812	43.802	123	97.890	99.360	96.320	188	149.612	151.093	148.049
58	46.177	47.610	44.614	124	98.687	100.155	97.124	189	150.408	151.888	148.840
59	46.973	48.408	45.393	125	99.482	100.950	97.912	190	151.205	152.683	149.642
60	47.768	49.202	46.205	126	100.278	101.747	98.715	191	152.000	153.480	150.432
61	48.565	50.000	46.964	127	101.075	102.542	99.503	192	152.795	154.275	151.232
62	49.360	50.795	47.797	128	101.870	103.337	100.307	193	153.590	155.070	152.023
63	50.155	51.593	48.576	129	102.665	104.135	101.095	194	154.387	155.868	152.824
64	50.950	52.390	49.387	130	103.460	104.930	101.897	195	155.183	156.663	153.615
65	51.745	53.185	50.167	131	104.257	105.727	102.686	196	155.977	157.458	154.414
66	52.540	53.982	50.977	132	105.052	106.522	103.489	197	156.775	158.255	155.206
67	53.337	54.777	51.759	133	105.847	107.317	104.278	198	157.570	159.050	156.007
68	54.132	55.575	52.569	134	106.643	108.115	105.080	199	158.365	159.845	156.798
69	54.927	56.370	53.350	135	107.440	108.910	105.869	200	159.162	160.643	157.599
70	55.723	57.167	54.160								

SPROCKETS



Sprocket Diameters

No. 240 3" Pitch

ROLLER CHAIN SPROCKET DIAMETERS

No. Teeth	Pitch Diameter	Outside Diameter	Caliper Diameter	No. Teeth	Pitch Diameter	Outside Diameter	Caliper Diameter	No. Teeth	Pitch Diameter	Outside Diameter	Caliper Diameter
6	6.000	7.00	4.125	45	43.007	44.70	41.105	83	79.278	81.02	77.388
7	6.914	8.03	4.866	46	43.961	45.66	42.086	84	80.233	81.98	78.358
8	7.839	9.04	5.964	47	44.915	46.61	43.013	85	81.188	82.93	79.298
9	8.771	10.04	6.764	48	45.869	47.57	43.994	86	82.142	83.89	80.267
10	9.708	11.03	7.833	49	46.824	48.53	44.925	87	83.097	84.84	81.207
11	10.649	12.02	8.666	50	47.778	49.49	45.903	88	84.052	85.80	82.177
12	11.591	13.00	9.716	51	48.732	50.44	46.833	89	85.006	86.75	83.116
13	12.536	13.97	10.568	52	49.687	51.40	47.812	90	85.961	87.71	84.086
14	13.482	14.94	11.607	53	50.641	52.35	48.744	91	86.916	88.67	85.026
15	14.429	15.91	12.473	54	51.595	53.31	49.720	92	87.871	89.62	85.996
16	15.377	16.88	13.502	55	52.550	54.26	50.654	93	88.825	90.58	86.938
17	16.327	17.85	14.383	56	53.504	55.22	51.629	94	89.780	91.53	87.905
18	17.276	18.81	15.401	57	54.458	56.18	52.562	95	90.735	92.48	88.848
19	18.227	19.78	16.289	58	55.413	57.13	53.538	96	91.690	93.44	89.815
20	19.177	20.74	17.302	59	56.368	58.09	54.473	97	92.645	94.40	90.758
21	20.129	21.71	18.197	60	57.322	59.04	55.447	98	93.599	95.35	91.724
22	21.080	22.67	19.205	61	58.277	60.00	56.384	99	94.554	96.31	92.667
23	22.032	23.63	20.106	62	59.231	60.95	57.356	100	95.507	97.26	93.634
24	22.984	24.59	21.109	63	60.185	61.91	58.292	101	96.463	98.22	94.676
25	23.936	25.55	22.013	64	61.140	62.87	59.265	102	97.418	99.17	95.543
26	24.889	26.51	23.014	65	62.095	63.82	60.202	103	98.373	100.13	96.486
27	25.841	27.47	23.921	66	63.049	64.78	61.174	104	99.328	101.08	97.453
28	26.794	28.43	24.919	67	64.004	65.73	62.111	105	100.283	102.04	98.396
29	27.747	29.39	25.833	68	64.958	66.69	63.083	106	101.237	102.99	99.362
30	28.700	30.34	26.825	69	65.913	67.64	64.023	107	102.192	103.95	100.305
31	29.654	31.30	27.740	70	66.868	68.60	64.993	108	103.147	104.90	101.272
32	30.607	32.26	28.732	71	67.822	69.56	65.932	109	104.102	105.86	102.215
33	31.560	33.22	29.649	72	68.777	70.51	66.902	110	105.056	106.82	103.181
34	32.514	34.18	30.639	73	69.731	71.45	67.841	111	106.011	107.77	104.124
35	33.467	35.13	31.559	74	70.686	72.42	68.811	112	106.966	108.72	105.091
36	34.421	36.09	32.546	75	71.641	73.38	69.751	113	107.922	109.68	106.035
37	35.375	37.05	33.467	76	72.595	74.33	70.720	114	108.876	110.63	107.001
38	36.329	38.00	34.454	77	73.550	75.29	71.660	115	109.830	111.59	107.943
39	37.283	38.96	35.378	78	74.505	76.25	72.630	116	110.786	112.55	108.911
40	38.237	39.92	36.362	79	75.459	77.20	73.569	117	111.740	113.50	109.820
41	39.191	40.88	37.286	80	76.414	78.16	74.539	118	112.695	114.46	110.810
42	40.145	41.83	38.270	81	77.369	79.11	75.479	119	113.650	115.41	111.750
43	41.099	42.79	39.197	82	78.323	80.07	76.448	120	114.605	116.36	112.730
44	42.053	43.75	40.178								

SPROCKETS

Horsepower Table



SPROCKETS

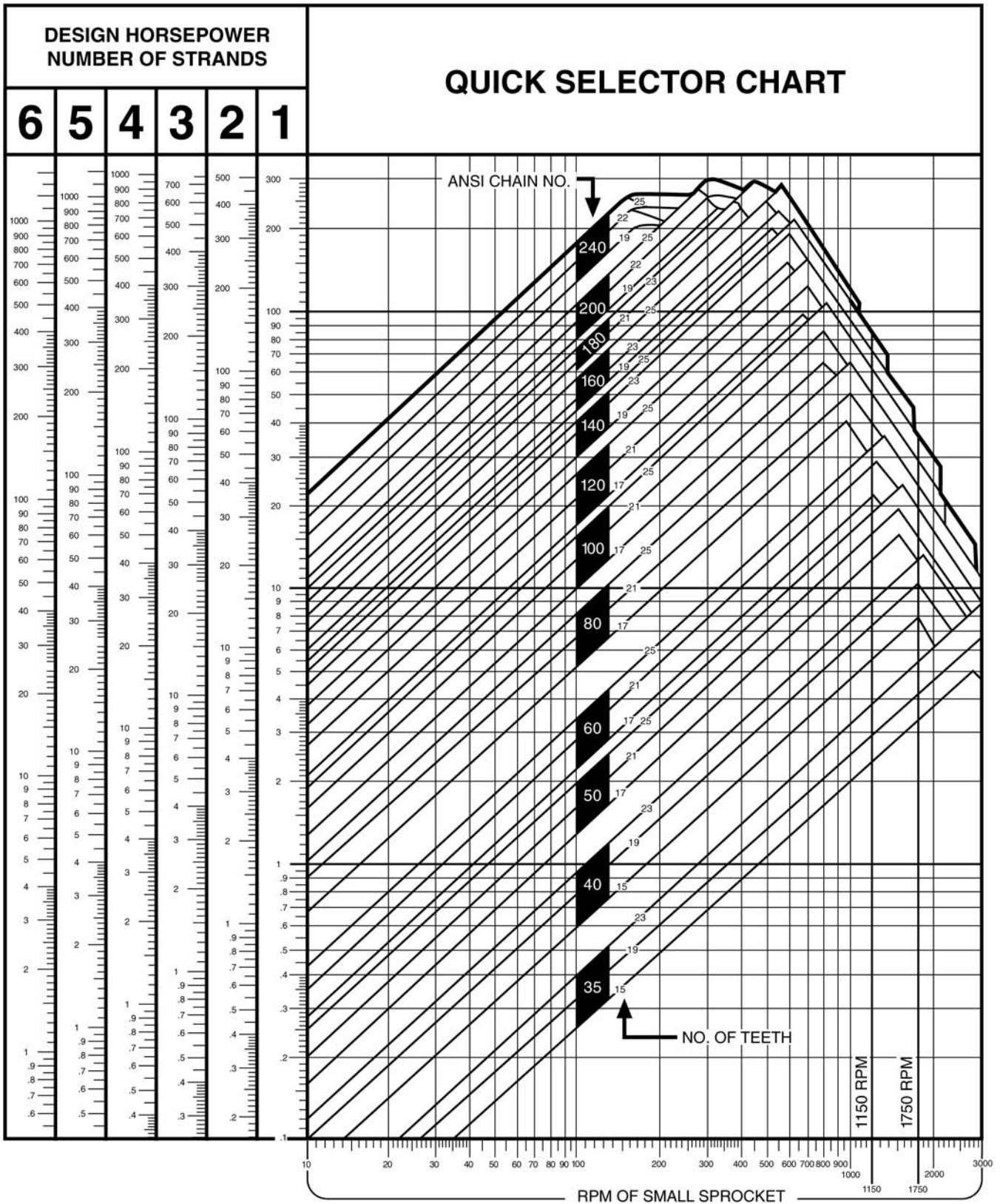

DOUBLE PITCH CHAIN

Sloping Lines Represent Horsepower Ratings
for Chains with 17 Tooth Sprockets

QUICK SELECTOR CHART

RECOMMENDED RANGES OF CHAIN CAPACITIES

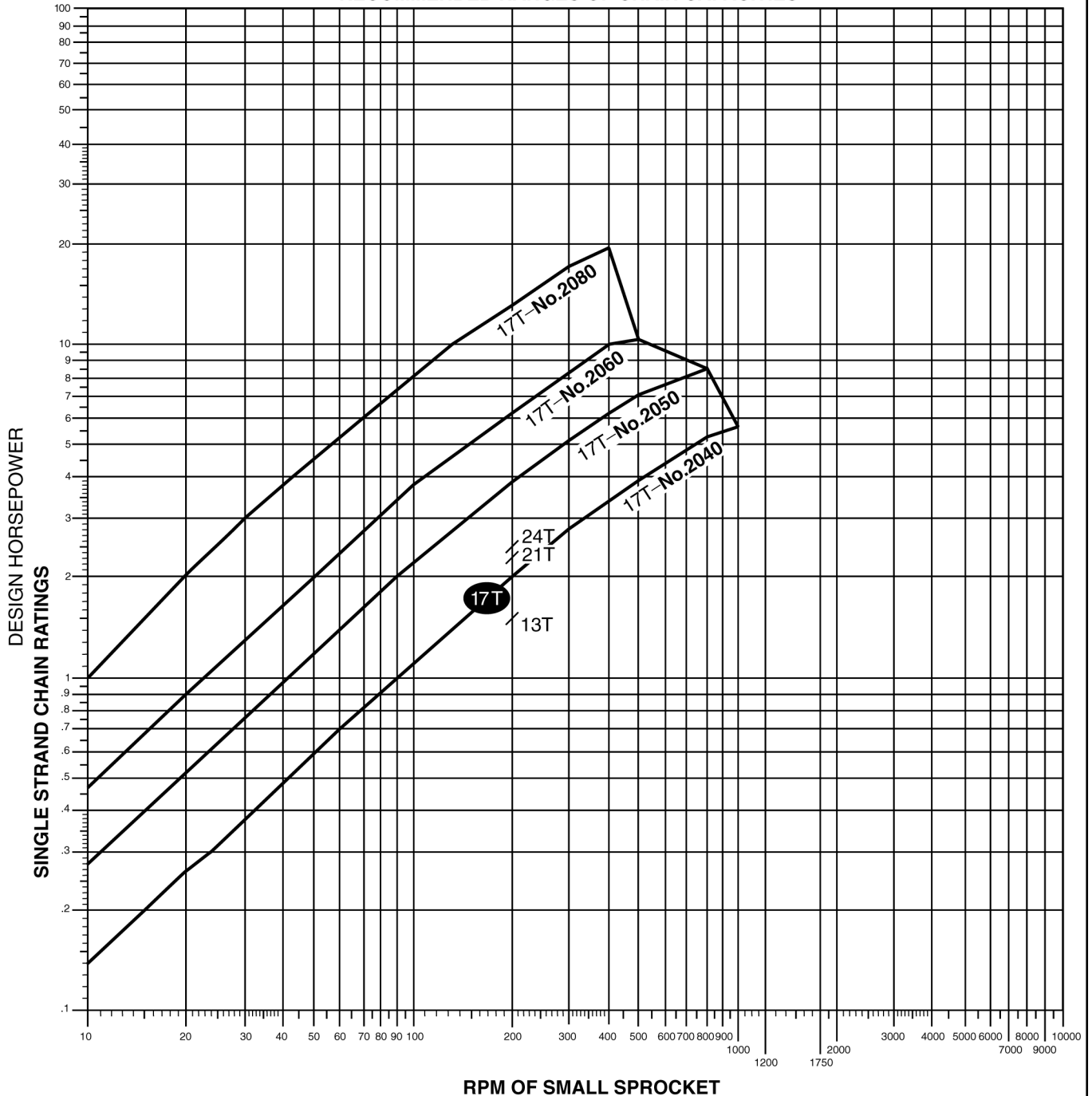

SPROCKETS

Horsepower Ratings Single Strand Roller Chain



(For Multiple Strand Ratings See Chart on Page E-187)

SPROCKETS

1/4" Pitch No. 25																				
No. of Teeth Small Sprocket	REVOLUTIONS PER MINUTE — SMALL SPROCKET																			
	100	500	900	1200	1800	2500	3000	3500	4000	4500	5000	5500	6000	6500	7000	7500	8000	8500	9000	10000
11	0.05	0.23	0.39	0.50	0.73	0.98	1.15	1.32	1.38	1.16	0.99	0.86	0.75	0.67	0.60	0.54	0.49	0.45	0.41	0.35
12	0.06	0.25	0.43	0.55	0.80	1.07	1.26	1.45	1.57	1.32	1.12	0.97	0.86	0.76	0.68	0.61	0.56	0.51	0.47	0.40
13	0.06	0.27	0.47	0.60	0.87	1.17	1.38	1.58	1.77	1.49	1.27	1.10	0.96	0.86	0.77	0.69	0.63	0.57	0.53	0.45
14	0.07	0.30	0.50	0.65	0.94	1.27	1.49	1.71	1.93	1.66	1.42	1.23	1.08	0.96	0.86	0.77	0.70	0.64	0.59	0.50
15	0.07	0.32	0.54	0.70	1.01	1.36	1.61	1.85	2.08	1.84	1.57	1.36	1.20	1.06	0.95	0.86	0.78	0.71	0.65	0.56
16	0.08	0.34	0.58	0.76	1.09	1.46	1.72	1.98	2.23	2.03	1.73	1.50	1.32	1.17	1.05	0.94	0.86	0.78	0.72	0.61
17	0.08	0.37	0.62	0.81	1.16	1.56	1.84	2.11	2.38	2.22	1.90	1.64	1.44	1.28	1.14	1.03	0.94	0.86	0.79	0.67
18	0.09	0.39	0.66	0.86	1.24	1.66	1.96	2.25	2.53	2.42	2.07	1.79	1.57	1.39	1.25	1.12	1.02	0.93	0.86	0.73
19	0.09	0.41	0.70	0.91	1.31	1.76	2.07	2.38	2.69	2.62	2.24	1.94	1.70	1.51	1.35	1.22	1.11	1.01	0.93	0.79
20	0.10	0.44	0.74	0.96	1.38	1.86	2.19	2.52	2.84	2.83	2.42	2.10	1.84	1.63	1.46	1.32	1.20	1.09	1.00	0.86
21	0.11	0.46	0.78	1.01	1.46	1.96	2.31	2.66	2.99	3.05	2.60	2.26	1.98	1.76	1.57	1.42	1.29	1.17	1.08	0.92
22	0.11	0.48	0.82	1.07	1.53	2.06	2.43	2.79	3.15	3.27	2.79	2.42	2.12	1.88	1.69	1.52	1.38	1.26	1.16	0.99
23	0.12	0.51	0.86	1.12	1.61	2.16	2.55	2.93	3.30	3.50	2.98	2.59	2.27	2.01	1.80	1.62	1.47	1.35	1.24	1.06
24	0.13	0.53	0.90	1.17	1.69	2.27	2.67	3.07	3.46	3.73	3.18	2.76	2.42	2.15	1.92	1.73	1.57	1.44	1.32	1.12
25	0.13	0.56	0.94	1.22	1.76	2.37	2.79	3.21	3.61	3.96	3.38	2.93	2.57	2.28	2.04	1.84	1.67	1.53	1.40	1.20
26	0.14	0.58	0.98	1.28	1.84	2.47	2.91	3.34	3.77	4.19	3.59	3.11	2.73	2.42	2.17	1.95	1.77	1.62	1.49	1.27
28	0.15	0.63	1.07	1.38	1.99	2.68	3.15	3.62	4.09	4.54	4.01	3.47	3.05	2.70	2.42	2.18	1.98	1.81	1.66	1.42
30	0.16	0.68	1.15	1.49	2.15	2.88	3.40	3.90	4.40	4.89	4.45	3.85	3.38	3.00	2.68	2.42	2.20	2.01	1.84	1.57
32	0.17	0.73	1.23	1.60	2.30	3.09	3.64	4.18	4.72	5.25	4.90	4.25	3.73	3.30	2.96	2.67	2.42	2.21	2.03	1.73
35	0.19	0.80	1.36	1.76	2.53	3.41	4.01	4.61	5.20	5.78	5.60	4.86	4.26	3.78	3.38	3.05	2.77	2.53	2.32	1.98
40	0.22	0.92	1.57	2.03	2.93	3.93	4.64	5.32	6.00	6.68	6.85	5.93	5.21	4.62	4.13	3.73	3.38	3.09	2.83	2.42
45	0.25	1.05	1.78	2.31	3.32	4.47	5.26	6.05	6.82	7.58	8.17	7.08	6.21	5.51	4.93	4.45	4.04	3.69	3.38	2.89
Lubrication	Type A	Type B							Type C											

3/8" Pitch No. 35																				
No. of Teeth Small Sprocket	REVOLUTIONS PER MINUTE — SMALL SPROCKET																			
	100	500	900	1200	1800	2500	3000	3500	4000	4500	5000	5500	6000	6500	7000	7500	8000	8500	9000	10000
11	0.18	0.77	1.31	1.70	2.45	3.30	2.94	2.33	1.91	1.60	1.37	1.18	1.04	0.92	0.82	0.74	0.67	0.62	0.57	0.48
12	0.20	0.85	1.44	1.87	2.70	3.62	3.35	2.66	2.17	1.82	1.56	1.35	1.18	1.05	0.94	0.85	0.77	0.70	0.64	0.55
13	0.22	0.93	1.57	2.04	2.94	3.95	3.77	3.00	2.45	2.05	1.75	1.52	1.33	1.18	1.06	0.95	0.87	0.79	0.73	0.62
14	0.24	1.01	1.71	2.21	3.18	4.28	4.22	3.35	2.74	2.30	1.96	1.70	1.49	1.32	1.18	1.07	0.97	0.88	0.81	0.69
15	0.25	1.08	1.84	2.38	3.43	4.61	4.68	3.71	3.04	2.55	2.17	1.88	1.65	1.47	1.31	1.18	1.07	0.98	0.90	0.77
16	0.27	1.16	1.97	2.55	3.68	4.94	5.15	4.09	3.35	2.81	2.40	2.08	1.82	1.62	1.45	1.30	1.18	1.08	0.99	0.85
17	0.29	1.24	2.10	2.73	3.93	5.28	5.64	4.48	3.67	3.07	2.62	2.27	2.00	1.77	1.58	1.43	1.30	1.18	1.09	0.93
18	0.31	1.32	2.24	2.90	4.18	5.61	6.15	4.88	3.99	3.35	2.86	2.48	2.17	1.93	1.73	1.56	1.41	1.29	1.18	1.01
19	0.33	1.40	2.37	3.07	4.43	5.95	6.67	5.29	4.33	3.63	3.10	2.69	2.36	2.09	1.87	1.69	1.53	1.40	1.28	1.10
20	0.35	1.48	2.51	3.25	4.68	6.29	7.20	5.72	4.68	3.92	3.35	2.90	2.55	2.26	2.02	1.82	1.65	1.51	1.39	1.18
21	0.37	1.56	2.64	3.42	4.93	6.63	7.75	6.15	5.03	4.22	3.60	3.12	2.74	2.43	2.17	1.96	1.78	1.62	1.49	1.27
22	0.38	1.64	2.78	3.60	5.19	6.97	8.21	6.59	5.40	4.52	3.86	3.35	2.94	2.61	2.33	2.10	1.91	1.74	1.60	1.37
23	0.40	1.72	2.92	3.78	5.44	7.31	8.62	7.05	5.77	4.83	4.13	3.58	3.14	2.79	2.49	2.25	2.04	1.86	1.71	1.46
24	0.42	1.80	3.05	3.96	5.70	7.66	9.02	7.51	6.15	5.15	4.40	3.81	3.35	2.97	2.66	2.40	2.17	1.99	1.82	1.56
25	0.44	1.88	3.19	4.13	5.95	8.00	9.43	7.99	6.54	5.48	4.68	4.05	3.56	3.16	2.82	2.55	2.31	2.11	1.94	1.65
26	0.46	1.96	3.33	4.31	6.21	8.35	9.84	8.47	6.93	5.18	4.96	4.30	3.77	3.35	3.00	2.70	2.45	2.24	2.05	1.75
28	0.50	2.12	3.61	4.67	6.73	9.05	10.7	9.47	7.75	6.49	5.55	4.81	4.22	3.74	3.35	3.02	2.74	2.50	2.30	1.96
30	0.54	2.29	3.89	5.03	7.25	9.74	11.5	10.5	8.59	7.20	6.15	5.33	4.68	4.15	3.71	3.35	3.04	2.77	2.55	2.17
32	0.58	2.45	4.17	5.40	7.77	10.4	12.3	11.6	9.47	7.93	6.77	5.87	5.15	4.57	4.09	3.69	3.35	3.06	2.81	...
35	0.64	2.70	4.59	5.95	8.56	11.5	13.6	13.2	10.8	9.08	7.75	6.72	5.90	5.23	4.68	4.22	3.83	3.50	3.21	...
40	0.73	3.12	5.30	6.87	9.89	13.3	15.7	16.2	13.2	11.1	9.47	8.21	7.20	6.39	5.72	5.15	4.68
45	0.83	3.55	6.02	7.80	11.2	15.1	17.8	19.3	15.8	13.2	11.3	9.79	8.59	7.62	6.82
Lubrication	Type A	Type B							Type C											

1/2" Pitch No. 41																	
No. of Teeth Small Sprocket	REVOLUTIONS PER MINUTE — SMALL SPROCKET																
	50	100	200	400	500	700	900	1200	1800	2400	3000	3500	4000	5000	6000	7000	8000
11	0.13	0.24	0.44	0.82	1.01	1.37	1.71	1.71	0.93	0.61	0.43	0.34	0.28	0.20	0.15	0.12	0.10
12	0.14	0.26	0.49	0.91	1.11	1.50	1.88	1.95	1.06	0.69	0.49	0.39	0.32	0.23	0.17	0.14	0.11
13	0.15	0.28	0.53	0.99	1.21	1.63	2.05	2.20	1.20	0.78	0.56	0.44	0.36	0.26	0.20	0.16	0.13
14	0.16	0.31	0.57	1.07	1.31	1.77	2.22	2.46	1.34	0.87	0.62	0.49	0.40	0.29	0.22	0.17	0.14
15	0.18	0.33	0.62	1.15	1.41	1.91	2.39	2.73	1.49	0.96	0.69	0.55	0.45	0.32	0.24	0.19	0.16
16	0.19	0.36	0.66	1.24	1.51	2.05	2.57	3.01	1.64	1.06	0.76	0.60	0.49	0.35	0.27	0.21	0.17
17	0.20	0.38	0.71	1.32	1.61	2.18	2.74	3.29	1.79	1.16	0.83	0.66	0.54	0.39	0.29	0.23	0.19
18	0.22	0.40	0.75	1.40	1.72	2.32	2.91	3.59	1.95	1.27	0.91	0.72	0.59	0.42	0.32	0.25	...
19	0.23	0.43	0.80	1.49	1.82	2.46	3.09	3.89	2.12	1.38	0.98	0.78	0.64	0.46	0.35	0.28	...
20	0.24	0.45	0.84	1.57	1.92	2.60	3.26	4.20	2.29	1.49	1.06	0.84	0.69	0.49	0.38	0.30	...
21	0.26	0.48	0.89	1.66	2.03	2.74	3.44	4.46	2.46	1.60	1.14	0.91	0.74	0.53	0.40	0.32	...
22	0.27	0.50	0.93	1.74	2.13	2.89	3.62	4.69	2.64	1.71	1.23	0.97	0.80	0.57	0.43	0.34	...
23	0.28	0.53	0.98	1.83	2.24	3.03	3.80	4.92	2.82	1.83	1.31	1.04	0.85	0.61	0.46	0.37	...
24	0.29	0.55	1.03	1.92	2.34	3.17	3.97	5.15	3.01	1.95	1.40	1.11	0.91	0.65	0.49	0.39	...
25	0.31	0.57	1.07	2.00	2.45	3.31	4.15	5.38	3.20	2.08	1.49	1.18	0.96	0.69	0.53
26	0.32	0.60	1.12	2.09	2.55	3.46	4.33	5.61	3.39	2.20	1.58	1.25	1.02	0.73	0.56
28	0.35	0.65	1.21	2.26	2.77	3.74	4.69	6.08	3.79	2.46	1.76	1.40	1.14	0.82	0.62
30	0.38	0.70	1.31	2.44	2.98												



Horsepower Ratings Single Strand Roller Chain

For Multiple Strand Ratings See Chart at Bottom

1/2" Pitch No. 40																	
No. of Teeth Small Sprocket	REVOLUTIONS PER MINUTE — SMALL SPROCKET																
	50	100	200	400	500	700	900	1200	1800	2400	3000	3500	4000	5000	6000	7000	8000
11	0.23	0.43	0.80	1.50	1.83	2.48	3.11	4.63	4.66	3.03	2.17	1.72	1.41	1.01	0.77	0.61	0.50
12	0.25	0.47	0.88	1.65	2.01	2.73	3.42	5.09	5.31	3.45	2.47	1.96	1.60	1.15	0.87	0.69	0.57
13	0.28	0.52	0.96	1.80	2.20	2.97	3.73	5.55	5.99	3.89	2.79	2.21	1.81	1.29	0.98	0.78	0.64
14	0.30	0.56	1.04	1.95	2.38	3.22	4.04	6.01	6.70	4.35	3.11	2.47	2.02	1.45	1.10	0.87	0.71
15	0.32	0.60	1.12	2.10	2.56	3.47	4.35	6.47	7.43	4.82	3.45	2.74	2.24	1.60	1.22	0.97	0.79
16	0.35	0.65	1.20	2.25	2.75	3.72	4.66	6.94	8.18	5.31	3.80	3.02	2.47	1.77	1.34	1.07	0.87
17	0.37	0.69	1.29	2.40	2.93	3.97	4.98	7.41	8.96	5.82	4.17	3.31	2.71	1.94	1.47	1.17	0.96
18	0.39	0.73	1.37	2.55	3.12	4.22	5.30	7.88	9.76	6.34	4.54	3.60	2.95	2.11	1.60	1.27	...
19	0.42	0.78	1.45	2.71	3.31	4.48	5.62	8.36	10.5	6.88	4.92	3.91	3.20	2.29	1.74	1.38	...
20	0.44	0.82	1.53	2.86	3.50	4.73	5.94	8.83	11.1	7.43	5.31	4.22	3.45	2.47	1.88	1.49	...
21	0.46	0.87	1.62	3.02	3.69	4.99	6.26	9.31	11.7	7.99	5.72	4.54	3.71	2.66	2.02	1.60	...
22	0.49	0.91	1.70	3.17	3.88	5.25	6.58	9.79	12.3	8.57	6.13	4.87	3.98	2.85	2.17	1.72	...
23	0.51	0.96	1.78	3.33	4.07	5.51	6.90	10.3	12.9	9.16	6.55	5.20	4.26	3.05	2.32	1.84	...
24	0.54	1.00	1.87	3.48	4.26	5.76	7.23	10.8	13.5	9.76	6.99	5.54	4.54	3.25	2.47	1.96	...
25	0.56	1.05	1.95	3.64	4.45	6.02	7.55	11.2	14.1	10.4	7.43	5.89	4.82	3.45	2.63
26	0.58	1.09	2.04	3.80	4.64	6.28	7.88	11.7	14.7	11.0	7.88	6.25	5.12	3.66	2.79
28	0.63	1.18	2.20	4.11	5.03	6.81	8.54	12.7	15.9	12.3	8.80	6.99	5.72	4.09	3.11
30	0.68	1.27	2.38	4.43	5.42	7.33	9.20	13.7	17.2	13.6	9.76	7.75	6.34	4.54	3.45
32	0.73	1.36	2.55	4.75	5.81	7.86	9.86	14.7	18.4	15.0	10.8	8.64	6.99	5.00
35	0.81	1.50	2.81	5.24	6.40	8.66	10.9	16.2	20.3	17.2	12.3	9.76	7.99	5.76
40	0.93	1.74	3.24	6.05	7.39	10.0	12.5	18.7	23.4	21.0	15.0	11.9	9.76	6.99
45	1.06	1.97	3.68	6.87	8.40	11.4	14.2	21.2	26.6	25.1	17.9	14.2	11.7
Lubrication	Type A			Type B					Type C								

5/8" Pitch No. 50																		
No. of Teeth Small Sprocket	REVOLUTIONS PER MINUTE — SMALL SPROCKET																	
	50	100	300	500	900	1200	1400	1800	2100	2400	2700	3000	3500	4000	4500	5000	5500	6000
11	0.45	0.84	2.25	3.57	6.06	7.85	8.13	5.58	4.42	3.62	3.04	2.59	2.06	1.68	1.41	1.20	1.04	0.92
12	0.49	0.92	2.47	3.92	6.65	8.62	9.26	6.35	5.04	4.13	3.46	2.95	2.34	1.92	1.61	1.37	1.19	1.04
13	0.54	1.00	2.70	4.27	7.25	9.40	10.4	7.16	5.69	4.65	3.90	3.33	2.64	3.16	1.81	1.55	1.34	...
14	0.58	1.09	2.92	4.63	7.86	10.2	11.7	8.01	6.35	5.20	4.36	3.72	2.95	2.42	2.03	1.73	1.50	...
15	0.73	1.17	3.15	4.99	8.47	11.0	12.6	8.88	7.05	5.77	4.83	4.13	3.27	2.68	2.25	1.92	1.66	...
16	0.67	1.26	3.38	5.35	9.08	11.8	13.5	9.78	7.76	6.35	5.32	4.55	3.61	2.95	2.47	2.11	1.83	...
17	0.72	1.34	3.61	5.71	9.69	12.6	14.4	10.7	8.50	6.96	5.83	4.98	3.95	3.23	2.71	2.31	2.01	...
18	0.76	1.43	3.83	6.07	10.3	13.4	15.3	11.7	9.26	7.58	6.35	5.42	4.30	3.52	2.95	2.52
19	0.81	1.51	4.07	6.44	10.9	14.2	16.3	12.7	10.0	8.22	6.89	5.88	4.67	3.82	3.20	2.73
20	0.86	1.60	4.30	6.80	11.5	15.0	17.2	13.7	10.8	8.88	7.44	6.35	5.04	4.13	3.46	2.95
21	0.90	1.69	4.53	7.17	12.2	15.8	18.1	14.7	11.7	9.55	8.01	6.84	5.42	4.44	3.72	3.18
22	0.95	1.77	4.76	7.54	12.8	16.6	19.1	15.8	12.5	10.2	8.59	7.39	5.82	4.76	3.99	3.41
23	1.00	1.86	5.00	7.91	13.4	17.4	20.0	16.9	13.4	11.0	9.18	7.84	6.22	5.09	4.27
24	1.04	1.95	5.23	8.29	14.1	18.2	20.9	18.0	14.3	11.7	9.78	8.35	6.33	5.42	4.55
25	1.09	2.03	5.47	8.66	14.7	19.0	21.9	19.1	15.2	12.4	10.4	8.88	7.05	5.77	4.83
26	1.14	2.12	5.70	9.03	15.3	19.9	22.8	20.3	16.1	13.2	11.0	9.42	7.47	6.12	5.13
28	1.23	2.30	6.18	9.79	16.6	21.5	24.7	22.6	18.0	14.7	12.3	10.5	8.35	6.84	5.73
30	1.33	2.49	6.66	10.5	17.9	23.2	26.6	25.1	19.9	16.3	13.7	11.7	9.26	7.58
32	1.42	2.66	7.14	11.3	19.2	24.9	28.6	27.7	22.0	18.0	15.1	12.9	10.2	8.35
35	1.57	2.93	7.86	12.5	21.1	27.4	31.5	31.6	25.1	20.6	17.2	14.7	11.7	9.55
40	1.81	3.38	9.08	14.4	24.4	31.6	36.3	38.7	30.7	25.1	21.0	18.0	14.3
45	2.06	3.84	10.3	16.3	27.7	35.9	41.3	46.1	36.6	30.0	25.1	21.4
Lubrication	Type A	Type B			Type C													

Type A Manual Lubrication
 Type B Bath or Disc Lubrication
 Type C Oil Stream Lubrication

Multiple Strand Factors

No. Strands	Strand Factor
1	1.0
2	1.9
3	2.8
4	3.7

SPROCKETS

Horsepower Ratings Single Strand Roller Chain



For Multiple Strand Ratings See Chart Page E-189

SPROCKETS

3/4" Pitch No. 60																
No. of Teeth Small Sprocket	REVOLUTIONS PER MINUTE — SMALL SPROCKET															
	50	100	200	500	700	900	1200	1400	1600	1800	2000	2500	3000	3500	4000	4500
11	0.77	1.44	2.69	6.13	8.30	10.4	11.9	9.41	7.70	6.45	5.51	3.94	3.00	2.38	1.95	1.63
12	0.85	1.58	2.95	6.74	9.12	11.4	13.5	10.7	8.77	7.35	6.28	4.49	3.42	2.71	2.22	1.86
13	0.92	1.73	3.22	7.34	9.94	12.5	15.2	12.1	9.89	8.29	7.08	5.06	3.85	3.06	2.50	...
14	1.00	1.87	3.49	7.96	10.8	13.5	17.0	13.5	11.1	9.26	7.91	5.66	4.31	3.42	2.80	...
15	1.08	2.01	3.76	8.57	11.6	14.5	18.8	15.0	12.3	10.3	8.77	6.28	4.77	3.79	3.10	...
16	1.16	2.16	4.03	9.19	12.4	15.6	20.2	16.5	13.5	11.3	9.66	6.91	5.26	4.17	3.42	...
17	1.24	2.31	4.30	9.81	13.3	16.7	21.6	18.1	14.8	12.4	10.6	7.57	5.76	4.57	3.74	...
18	1.31	2.45	4.58	10.4	14.1	17.7	22.9	19.7	16.1	13.5	11.5	8.25	6.28	4.98	4.08	...
19	1.39	2.60	4.85	11.1	15.0	18.8	24.3	21.4	17.5	14.6	12.5	8.95	6.81	5.40	4.42	...
20	1.47	2.75	5.13	11.7	15.8	19.8	25.7	23.1	18.9	15.8	13.5	9.66	7.35	5.83
21	1.55	2.90	5.40	12.3	16.7	20.9	27.1	24.8	20.3	17.0	14.5	10.4	7.91	6.28
22	1.63	3.05	5.68	13.0	17.5	22.0	28.5	26.6	21.8	18.2	15.6	11.1	8.48	6.73
23	1.71	3.19	5.96	13.6	18.4	23.1	29.9	28.4	23.3	19.5	16.7	11.9	9.07	7.19
24	1.79	3.35	6.24	14.2	19.3	24.1	31.3	30.3	24.8	20.8	17.8	12.7	9.66	7.67
25	1.87	3.50	6.52	14.9	20.1	25.3	32.7	32.2	26.4	22.1	18.9	13.5	10.3	8.15
26	1.95	3.65	6.81	15.5	21.0	26.4	34.1	34.2	28.0	23.4	20.0	14.3	10.9	8.65
28	2.12	3.95	7.37	16.8	22.8	28.5	37.0	38.2	31.3	26.2	22.4	16.0	12.2
30	2.28	4.26	7.94	18.1	24.5	30.8	39.8	42.4	34.7	29.1	24.8	17.8	13.5
32	2.45	4.56	8.52	19.4	26.3	33.0	42.7	46.7	38.2	32.0	27.3	19.6	14.9
35	2.69	5.03	9.38	21.4	29.0	36.3	47.1	53.4	43.7	36.6	31.3	22.4	17.0
40	3.11	5.81	10.8	23.7	33.5	42.0	54.4	62.5	53.4	44.7	38.2	27.3
45	3.53	6.60	12.3	28.1	38.0	47.7	61.7	70.9	63.7	53.4	45.6	32.6
Lubrication	Type A	Type B				Type C										

1" Pitch No. 80																				
No. of Teeth Small Sprocket	REVOLUTIONS PER MINUTE — SMALL SPROCKET																			
	25	50	100	200	300	400	500	700	900	1000	1200	1400	1600	1800	2000	2200	2400	2700	3000	3400
11	0.97	1.80	3.36	6.28	9.04	11.7	14.3	19.4	23.0	19.6	14.9	11.8	9.69	8.12	6.93	6.01	5.27	4.42	3.77	1.70
12	1.06	1.98	3.69	6.89	9.93	12.9	15.7	21.3	26.2	22.3	17.0	13.5	11.0	9.25	7.90	6.85	6.01	5.04	4.30	...
13	1.16	2.16	4.03	7.52	10.8	14.0	17.1	23.2	29.1	25.2	19.2	15.2	12.5	10.4	8.91	7.72	6.78	5.68	4.85	...
14	1.25	2.34	4.36	8.14	11.7	15.2	18.6	25.1	31.5	28.2	21.4	17.0	13.9	11.7	9.96	8.83	7.57	6.35	5.42	...
15	1.35	2.52	4.70	8.77	12.6	16.4	20.0	27.1	34.0	31.2	23.8	18.9	15.4	12.9	11.0	9.57	8.40	7.04	6.01	...
16	1.45	2.70	5.04	9.41	13.5	17.6	21.5	29.0	36.4	34.4	26.2	20.8	17.0	14.2	12.2	10.5	9.25	7.76	6.62	...
17	1.55	2.88	5.38	10.0	14.5	18.7	22.9	31.0	38.9	37.7	28.7	22.7	18.6	15.6	13.3	11.5	10.1	8.49	7.25	...
18	1.64	3.07	5.72	10.7	15.4	19.9	24.4	33.0	41.4	41.1	31.2	24.8	20.3	17.0	14.5	12.6	11.0	9.25	7.90	...
19	1.74	3.25	6.07	11.3	16.3	21.1	25.8	35.0	43.8	44.5	33.9	26.9	22.0	18.4	15.7	13.6	12.0	10.0	8.57	...
20	1.84	3.44	6.41	12.0	17.2	22.3	27.3	37.0	46.3	48.1	36.6	29.0	23.8	19.9	17.0	14.7	12.9	10.8
21	1.94	3.62	6.76	12.6	18.2	23.5	28.8	39.0	48.9	51.7	39.4	31.2	25.6	21.4	18.3	15.9	13.9	11.7
22	2.04	3.81	7.11	13.3	19.1	24.8	30.3	41.0	51.4	55.5	42.2	33.5	27.4	23.0	19.6	17.0	14.9	12.5
23	2.14	4.00	7.46	13.9	20.1	26.0	31.8	43.0	53.9	59.3	45.1	35.8	29.3	24.6	21.0	18.2	15.9	13.4
24	2.24	4.19	7.81	14.6	21.0	27.2	33.2	45.0	56.4	62.0	48.1	38.2	31.2	26.2	22.3	19.4	17.0	14.2
25	2.34	4.37	8.16	15.2	21.9	28.4	34.7	47.0	59.0	64.8	51.1	40.6	33.2	27.8	23.8	20.6	18.1	15.1
26	2.45	4.56	8.52	15.9	22.9	29.7	36.2	49.1	61.5	67.6	54.2	43.0	35.2	29.5	25.2	21.8	19.2	16.1
28	2.65	4.94	9.23	17.2	24.8	32.1	39.3	53.2	66.7	73.3	60.6	48.1	39.4	33.0	28.2	24.4	21.4
30	2.85	5.33	9.94	18.5	26.7	34.6	42.3	57.3	71.8	78.9	67.2	53.3	43.6	36.6	31.2	27.1	23.8
32	3.06	5.71	10.7	19.9	28.6	37.1	45.4	61.4	77.0	84.6	74.0	58.7	48.1	40.3	34.4	29.8	26.2
35	3.37	6.29	11.7	21.9	31.6	40.9	50.0	67.6	84.8	93.3	84.7	67.2	55.0	46.1	39.4	34.1
40	3.89	7.27	13.6	25.3	36.4	47.2	57.7	78.1	98.0	108	103	82.1	67.2	56.3	48.1	40.0
45	4.42	8.25	15.4	28.7	41.4	53.6	65.6	88.7	111	122	123	98.0	80.2	67.2	54.1
Lubrication	Type A	Type B				Type C														

1 1/4" Pitch No. 100																							
No. of Teeth Small Sprocket	REVOLUTIONS PER MINUTE — SMALL SPROCKET																						
	10	25	50	100	200	300	400	500	600	700	800	900	1000	1100	1200	1300	1400	1600	1800	2000	2200	2400	2600
11	0.81	1.85	3.45	6.44	12.0	17.3	22.4	27.4	32.3	37.1	32.8	27.5	23.4	20.3	17.8	15.8	14.2	11.6	9.71	8.29	7.19	6.31	1.29
12	0.89	2.03	3.79	7.08	13.2	19.0	24.6	30.1	35.5	40.8	37.3	31.3	26.7	23.2	20.3	18.0	16.1	13.2	11.1	9.45	8.19	7.19	...
13	0.97	2.22	4.13	7.72	14.4	20.7	26.9	32.8	38.7	44.5	42.1	35.3	30.1	26.1	22.9	20.3	18.2	14.9	12.5	10.6	9.23	8.10	...
14	1.05	2.40	4.48	8.36	15.6	22.5	29.1	35.6	41.9	48.2	47.0	39.4	33.7	29.2	25.6	22.7	20.3	16.6	13.9	11.9	10.3	9.06	...
15	1.13	2.59	4.83	9.01	16.8	24.2	31.4	38.3	45.2	51.9	52.2	43.7	37.3	32.4	28.4	25.2	22.5	18.4	15.5	13.2	11.4	10.0	...
16	1.22	2.77	5.17	9.66	18.0	26.0	33.6	41.1	48.4	55.6	57.5	48.2	41.1	35.7	31.3	27.7	24.8	20.3	17.0	14.5	12.8	11.1	...
17	1.30	2.96	5.52	10.3	19.2	27.7	35.9	43.9	51.7	59.4	63.0	52.8	45.0	39.0	34.3	30.4	27.2	22.3	18.7	15.9	13.8	0.79	...
18	1.38	3.15	5.88	11.0	20.5	29.5	38.2	46.7	55.0	63.2	68.6	57.5	49.1	42.5	37.3	33.1	29.6	24.2	20.3	17.4	15.0
19	1.46	3.34	6.23	11.6	21.7	31.2	40.5	49.5	58.3	67.0	74.4	62.3	53.2	46.1	40.5	35.9	32.1	26.3	22.0	18.8	16.3
20	1.55	3.53	6.58	12.3	22.9	33.0	42.8	52.3	61.6	70.8	79.8	67.3	57.5	49.8	43.7	38.8	34.7	28.4	23.8	20.3	17.6
21	1.63	3.72	6.94	13.0	24.2	34.8	45.1	55.1	65.0	74.6	84.2	72.4	61.8	53.6	47.0	41.7	37.3	30.6	25.6	21.9	19.0
22	1.71	3.91	7.30	13.6	25.4	36.6	47.4	58.0	68.3	78.5	88.5	77.7	66.3	57.5	50.4	44.7	40.0	32.8	27.5	23.4	20.3
23	1.80	4.10	7.66	14.3	26.7	38.4	49.8	60.8	71.7	82.3	92.8	83.0	70.9	61.4	53.9	47.8	42.8	35.0	29.4	25.1	21.7
24	1.88	4.30	8.02	15.0	27.9	40.2	52.1	63.7	75.0	86.2	97.2	88.5	75.6	65.5	57.5	51.0	45.6	37.3	31.3	26.7
25	1.97	4.49	8.38	15.6	29.2	42.0	54.4	66.6	78.4	90.1	102	94.1	80.3	69.6	61.1	54.2	48.5	39.7	33.3	28.4
26	2.05	4.68	8.74	16.3	30.4	43.8	56.8	69.4	81.8	94.0	106	99.8	85.2	73.8	64.8	57.5	51.4	42.1	35.3	30.1
28	2.22	5.07	9.47	17.7	33.0	47.5	61.5	75.2	88.6	102	115	112	95.2	82.5	72.4	64.2	57.5	47.0	39.4	33.7
30	2.40	5.47	10.2	19.0	35.5	51.2	66.3	81.0	95.5	110	124	124	106	91.5	80.3	71.2	63.7	52.2	43.7	37.4
32	2.57	5.86	10.9	20.4	38.1	54.9	71.1	86.9															



Horsepower Ratings Single Strand Roller Chain

For Multiple Strand Ratings See Chart at Bottom

1 1/2" Pitch No. 120																									
No. of Teeth Small Sprocket	REVOLUTIONS PER MINUTE — SMALL SPROCKET																								
	10	25	50	100	150	200	300	400	500	600	700	800	900	1000	1100	1200	1300	1400	1500	1600	1700	1800	1900	2000	2100
11	1.37	3.12	5.83	10.9	15.7	20.3	29.2	37.9	46.3	54.6	46.3	37.9	31.8	27.1	23.5	20.6	18.3	16.4	13.8	14.4	12.2	11.2	10.4	9.59	...
12	1.50	3.43	6.40	11.9	17.2	22.3	32.1	41.6	50.9	59.9	52.8	43.2	36.2	30.9	26.8	23.5	20.9	18.7	16.8	15.3	13.9	12.8	11.8	10.9	...
13	1.64	3.74	6.98	13.0	18.8	24.3	35.0	45.4	55.5	65.3	59.5	48.7	40.8	34.9	30.2	26.5	23.5	21.0	19.0	17.2	15.7	14.4	13.3	12.3	...
14	1.78	4.05	7.56	14.1	20.3	26.3	37.9	49.1	60.1	70.8	66.5	54.4	45.6	39.0	33.8	29.6	26.3	23.5	21.2	19.2	17.6	16.1	14.9	8.94	...
15	1.91	4.37	8.15	15.2	21.9	28.4	40.9	53.0	64.7	76.3	73.8	60.4	50.6	43.2	37.4	32.9	29.1	26.1	23.5	21.3	19.5	17.0	16.5
16	2.05	4.68	8.74	16.3	23.5	30.4	43.8	56.8	69.4	81.8	81.3	66.5	55.7	47.6	41.2	36.2	32.1	28.7	25.9	23.5	21.5	19.7	18.2
17	2.19	5.00	9.33	17.4	25.1	32.5	46.8	60.6	74.1	87.3	89.0	72.8	61.0	52.1	45.2	39.6	35.2	31.5	28.4	25.8	23.5	21.6	19.9
18	2.33	5.32	9.92	18.5	26.7	34.6	49.8	64.5	78.8	92.9	97.0	79.4	66.5	56.8	49.2	43.2	38.3	34.3	30.9	28.1	25.6	23.5	11.3
19	2.47	5.64	10.5	19.6	28.3	36.6	52.8	68.4	83.6	98.5	105	86.1	72.1	61.6	53.4	46.8	41.5	37.2	33.5	30.4	27.8	25.5
20	2.61	5.96	11.1	20.7	29.9	38.7	55.8	72.2	88.3	104	114	92.9	77.9	66.5	57.6	50.6	44.9	40.1	36.2	32.9	30.0	27.5
21	2.75	6.28	11.7	21.9	31.5	40.8	58.8	76.2	98.1	110	122	100	83.8	71.6	62.0	54.4	48.3	43.2	39.0	35.4	32.3	29.6
22	2.90	6.60	12.3	23.0	33.1	42.9	61.8	80.1	97.9	115	131	107	89.9	76.7	66.5	58.4	51.8	46.3	41.8	37.9	34.6	16.6
23	3.04	6.93	12.9	24.1	34.8	45.0	64.9	84.0	103	121	139	115	96.1	82.0	71.1	62.4	55.3	49.5	44.6	40.5	37.0
24	3.18	7.25	13.5	25.3	36.4	47.1	67.9	88.0	108	127	146	122	102	87.4	75.8	66.5	59.0	52.8	47.6	43.2	39.4
25	3.32	7.58	14.1	26.4	38.0	49.3	71.0	91.9	112	132	152	130	109	92.9	80.6	70.7	62.7	56.1	50.6	45.9	41.3
26	3.47	7.91	14.8	27.5	39.7	51.4	74.0	95.9	117	138	159	138	115	98.6	85.4	75.0	66.5	59.5	53.7	48.7	26.6
28	3.76	8.57	16.0	29.8	43.0	55.7	80.2	104	127	150	172	154	129	110	95.5	83.8	74.3	66.5	60.0	54.4
30	4.05	9.23	17.2	32.1	46.3	60.0	86.4	112	137	161	185	171	143	122	106	92.9	82.4	73.8	66.5	42.4
32	4.34	9.90	18.5	34.5	49.6	64.3	92.6	120	147	173	199	188	158	135	117	102	90.8	81.3	73.3
35	4.78	10.9	20.3	38.0	54.7	70.9	102	132	162	190	219	215	180	154	133	117	104	92.9	47.7
50	5.52	12.6	23.5	43.9	63.2	81.8	118	153	187	220	253	263	220	188	163	143	127	59.5
45	6.27	14.3	26.7	49.8	71.7	92.9	134	173	212	250	287	314	263	224	195	171	80.0
Lubrication	Type A	Type B										Type C													

1 3/4" Pitch No. 140																									
No. of Teeth Small Sprocket	REVOLUTIONS PER MINUTE — SMALL SPROCKET																								
	10	25	50	100	150	200	250	300	350	400	450	500	550	600	700	800	900	1000	1100	1200	1300	1400	1500	1600	1700
11	2.12	4.83	9.02	16.8	24.2	31.4	38.4	45.2	52.0	58.6	65.2	71.6	75.2	66.0	52.4	42.9	35.9	30.7	26.6	23.3	20.7	18.5	16.7	15.2	...
12	2.33	5.31	9.91	18.5	26.6	34.5	42.2	49.7	57.1	64.4	71.6	78.7	85.7	75.2	59.7	48.9	41.0	35.0	30.3	26.6	23.6	21.1	19.0	17.3	...
13	2.54	5.79	10.8	20.2	29.0	37.6	46.0	54.2	62.2	70.2	78.0	85.8	93.5	84.8	67.3	55.1	46.2	39.4	34.2	30.0	26.5	23.8	21.5	19.5	...
14	2.75	6.27	11.7	21.8	31.5	40.8	49.8	58.7	67.4	76.0	84.5	93.0	101	94.8	75.2	61.6	51.6	44.1	38.2	33.5	29.7	26.6	24.0	21.8	...
15	2.96	6.76	12.6	23.5	33.9	43.9	53.7	63.2	72.7	81.9	91.1	100	109	105	83.4	68.3	57.2	48.9	42.4	37.2	33.0	29.5	26.6
16	3.18	7.24	13.5	25.2	36.3	47.1	57.5	67.8	77.9	87.8	97.7	107	117	116	91.9	75.2	63.1	53.8	46.7	41.0	36.3	32.5	29.3
17	3.39	7.73	14.4	26.9	38.8	50.3	61.4	72.4	83.2	93.8	104	115	125	127	101	82.4	69.1	59.0	51.1	44.9	39.8	35.6	32.1
18	3.61	8.23	15.4	28.6	41.3	53.5	65.3	77.0	88.5	99.8	111	122	133	138	110	89.8	75.2	64.2	55.7	48.9	43.3	38.8	35.0
19	3.82	8.72	16.3	30.4	43.7	56.7	60.3	81.6	93.8	106	118	129	141	150	119	97.4	81.6	69.7	50.4	53.0	47.0	42.1	37.9
20	4.04	9.22	17.2	32.1	46.2	59.9	73.2	86.3	99.1	112	124	137	149	161	128	105	88.1	75.2	65.2	57.2	50.8	45.4
21	4.26	9.72	18.1	33.8	48.7	63.1	77.2	91.0	104	118	131	144	157	170	138	113	94.8	80.9	70.2	61.6	54.6	48.9
22	4.48	10.2	19.1	35.6	51.3	66.4	81.2	95.6	110	124	138	151	165	178	148	121	102	86.8	75.2	66.0	58.6	52.4
23	4.70	10.7	20.0	37.3	53.8	69.7	85.2	100	115	130	145	159	173	187	158	130	109	92.8	80.4	70.6	62.6	56.0
24	4.92	11.2	20.9	39.1	56.3	72.9	89.2	105	121	136	151	166	181	196	169	138	116	98.9	85.7	75.2	66.7	59.7
25	5.14	11.7	21.9	40.8	58.8	76.2	93.2	110	126	142	158	174	189	205	180	147	123	105	91.1	80.0	70.9	63.5
26	5.37	12.2	22.8	42.6	61.4	79.5	97.2	115	132	148	165	181	198	214	190	156	131	112	96.7	84.8	75.2
28	5.81	13.3	24.7	46.2	66.5	86.2	105	124	143	161	179	197	214	232	213	174	146	125	108	94.8	84.1
30	6.26	14.3	26.7	49.7	71.6	92.8	113	134	154	173	193	212	231	249	236	193	162	138	120	105	93.2
32	6.71	15.3	28.6	53.3	76.8	99.5	122	143	165	186	206	227	247	267	260	213	178	152	132	116
35	7.40	16.9	31.5	58.7	84.6	110	134	158	181	205	227	250	272	295	297	243	204	174	151	130
40	8.54	19.5	36.4	67.9	97.7	127	155	182	210	236	263	289	315	340	363	297	249	213	178
45	9.70	22.1	41.3	79.1	111	144	176	207	238	268	298	328	357	387	434	355	297	237	92.7
Lubrication	Type A	Type B										Type C													

Type A Manual Lubrication
Type B Bath or Disc Lubrication
Type C Oil Stream Lubrication

Multiple Strand Factors

No. Strands	Strand Factor
1	1.0
2	1.9
3	2.8
4	3.7

SPROCKETS

Horsepower Ratings Single Strand Roller Chain



For Multiple Strand Ratings See Chart Page E-191

2" Pitch No. 160																								
No. of Teeth Small Sprocket	REVOLUTIONS PER MINUTE — SMALL SPROCKET																							
	10	25	50	100	150	200	250	300	350	400	450	500	550	600	650	700	750	800	850	900	1000	1100	1200	1300
11	3.07	7.01	13.1	24.4	35.2	45.6	55.7	65.6	75.4	85.0	94.5	96.6	83.7	73.5	65.2	58.3	52.6	47.7	43.6	40.0	34.1	29.6	26.0	23.0
12	3.38	7.70	14.4	26.8	38.6	50.1	61.2	72.1	82.8	93.4	104	110	95.4	83.7	74.2	66.4	59.9	54.4	49.6	45.6	38.9	33.7	29.6	26.3
13	3.68	8.40	15.7	29.2	42.1	54.6	66.7	78.6	90.3	102	113	124	108	94.4	83.7	74.9	67.5	61.3	56.0	51.4	43.9	38.0	33.4	29.6
14	3.99	9.10	17.0	31.7	45.6	59.1	72.3	85.2	97.8	110	123	135	120	105	93.6	83.7	75.5	68.5	62.6	57.4	49.0	42.5	37.3	33.1
15	4.30	9.80	18.3	34.1	49.2	63.7	77.9	91.7	105	119	132	145	133	117	104	92.8	83.7	76.0	69.4	63.7	45.4	47.1	41.4	...
16	4.61	10.5	19.6	36.6	52.7	68.3	83.5	98.4	113	127	142	156	147	129	114	102	92.2	83.7	76.4	70.2	59.9	51.9	45.6	...
17	4.92	11.2	20.9	39.1	56.3	72.9	89.1	105	121	136	151	166	161	141	125	112	101	91.7	83.7	75.8	65.6	56.9	49.9	...
18	5.23	11.9	22.3	41.6	59.9	77.6	94.8	112	128	145	161	177	175	154	136	122	110	99.9	91.2	83.7	71.5	62.0	54.4	...
19	5.55	12.7	23.6	44.1	63.5	82.2	101	118	136	153	171	188	190	167	148	132	119	108	98.9	90.8	77.6	67.2	59.0	...
20	5.86	13.4	25.0	46.6	67.1	86.9	106	125	144	162	180	198	205	180	160	143	129	117	93.1	83.7	72.6	63.7
21	6.18	14.1	26.3	49.1	70.7	91.6	112	132	152	171	190	209	221	194	172	154	139	126	115	105	90.1	78.1	68.5	...
22	6.50	14.8	27.7	51.6	74.4	96.3	118	139	159	180	200	220	237	208	184	165	149	135	123	113	96.6	83.7
23	6.82	15.6	29.0	54.2	78.0	101	124	146	167	189	210	231	251	222	197	176	159	144	132	121	103	98.5
24	7.14	16.3	30.4	56.7	81.7	106	129	152	175	197	220	241	263	237	210	188	169	154	140	129	110	95.4
25	7.46	17.0	31.8	59.3	85.4	111	135	159	183	206	229	252	275	252	223	200	180	164	149	137	117	101
26	7.78	17.8	33.1	61.8	89.1	115	141	166	191	215	239	263	287	267	237	212	191	173	158	145	124	108
28	8.43	19.2	35.9	67.0	96.5	125	153	180	207	233	259	285	311	298	265	237	214	194	177	162	139	120
30	9.08	20.7	38.7	72.2	104	135	165	194	223	251	279	307	335	331	293	263	237	215	196	180	154
32	9.74	22.2	41.5	77.4	111	144	176	208	239	269	300	329	359	365	323	289	261	237	216	198	169
35	10.7	24.5	45.7	85.2	123	159	194	229	263	297	330	363	395	417	370	331	298	271	247	227	180
40	12.4	28.3	52.8	98.5	142	184	225	265	304	343	381	419	457	494	452	404	365	331	302	257
45	14.1	32.1	59.9	112	161	209	255	301	345	389	433	476	519	561	538	482	418	348	271	189
Lubrication	Type A	Type B										Type C												

2 1/4" Pitch No. 180																								
No. of Teeth Small Sprocket	REVOLUTIONS PER MINUTE — SMALL SPROCKET																							
	10	25	50	100	150	200	250	300	350	400	450	500	550	600	650	750	800	850	900	950	1000	1050	1100	1150
11	4.24	9.68	18.1	33.7	48.6	62.9	76.9	90.6	104	117	124	106	92.0	80.7	71.6	57.8	52.4	47.9	43.9	40.5	37.5	34.9	32.5	...
12	4.66	10.6	19.8	37.0	53.4	69.1	84.5	99.6	114	129	142	121	105	92.0	81.6	65.8	59.7	54.6	50.1	46.2	42.8	39.7	37.1	...
13	5.08	11.6	21.6	40.4	58.2	75.4	92.1	109	125	141	156	136	118	104	92.0	74.2	67.4	61.5	55.5	52.1	48.2	44.8
14	5.51	12.6	23.4	43.7	63.0	81.6	99.8	118	135	152	169	152	132	116	103	82.9	75.3	68.7	63.1	58.2	53.9	50.1
15	5.93	13.5	25.3	47.1	67.9	88.0	108	127	146	164	182	169	146	129	114	92.0	83.5	76.2	70.0	64.5	59.7	55.5
16	6.36	14.5	27.1	50.5	72.8	94.3	115	136	156	176	196	186	161	142	126	101	92.0	84.0	77.1	71.1	65.8	61.2
17	6.79	15.5	28.9	54.0	77.7	101	123	145	167	188	209	204	177	155	138	111	101	92.0	84.4	77.9	72.1
18	7.22	16.5	30.8	57.4	82.7	107	131	154	177	200	222	222	193	169	150	121	110	100	92.0	84.8	78.5
19	7.66	17.5	32.6	60.8	87.6	114	139	164	188	212	236	241	209	183	163	131	119	109	99.8	90.8	85.2
20	8.10	18.5	34.5	64.3	92.6	120	147	173	199	224	249	260	226	198	175	142	129	117	108	99.3	92.0
21	8.53	19.5	36.3	67.8	97.6	126	155	182	209	236	262	280	243	213	189	152	138	126	116	107	99.0
22	8.97	20.5	38.2	71.3	103	133	163	192	220	248	276	300	260	228	203	163	148	135	124	115
23	9.41	21.5	40.1	74.8	108	140	171	201	231	260	290	318	278	244	216	175	159	145	133	123
24	9.86	22.5	42.0	78.3	113	146	179	210	242	273	303	333	296	260	231	186	169	154	142	131
25	10.3	23.5	43.9	81.8	118	153	187	220	253	285	317	348	315	277	245	198	180	164	151	139
26	10.7	24.5	45.7	85.4	123	159	195	229	264	297	331	363	334	293	260	210	191	174	160
28	11.6	26.6	49.6	92.5	133	173	211	249	286	322	358	394	374	328	291	235	213	194	178
30	12.5	28.6	53.4	99.6	144	186	227	268	308	347	386	424	414	364	322	260	236	216	198
32	13.4	30.7	57.2	107	154	199	244	287	330	372	414	455	466	401	355	287	260	238
35	14.8	33.8	63.1	118	170	220	268	316	363	410	456	501	522	458	406	328	291	220
40	17.7	39.0	72.9	136	196	254	310	365	420	473	526	579	575	524	465	324	244
45	19.4	44.3	82.7	154	222	288	352	415	477	538	598	631	578	514	441	271
Lubrication	Type A	Type B										Type C												

2 1/2" Pitch No. 200																		
No. of Teeth Small Sprocket	REVOLUTIONS PER MINUTE — SMALL SPROCKET																	
	10	15	20	30	40	50	70	100	150	200	250	300	350	400	450	550	650	
11	5.64	8.12	10.5	15.1	19.6	24.0	32.5	44.8	64.5	83.5	102	120	138	156	135	100	87.8	77.9
12	6.19	8.92	11.6	16.6	21.6	26.4	35.7	49.2	70.8	91.8	112	132	152	171	154	114	100	...
13	6.75	9.72	12.6	18.1	23.5	28.7	38.9	53.6	77.2	100	122	144	168	187	174	129	113	...
14	7.31	10.5	13.6	19.7	25.5	31.1	42.1	58.1	83.7	108	132	156	179	202	194	144	126	...
15	7.88	11.3	14.7	21.2	27.4	33.5	45.4	62.6	90.1	117	143	168	183	218	215	159	140	...
16	8.45	12.2	15.8	22.7	29.4	36.0	48.7	67.1	96.6	125	153	180	207	234	237	176	154	...
17	9.02	13.0	16.8	24.2	31.4	38.4	52.0	71.6	103	134	163	193	221	249	260	192	169	...
18	9.59	13.8	17.9	25.8	33.4	40.8	55.3	76.2	110	142	174	205	235	265	283	209	184	...
19	10.2	14.6	19.0	27.3	35.4	43.3	58.6	80.8	116	151	184	217	249	281	307	227	198	...
20	10.7	15.5	20.1	28.9	37.4	45.8	61.9	85.4	123	159	195	229	264	297	331	245
21	11.3	16.3	21.1	30.5	39.5	48.2	65.3	90.0	130	168	205	242	278	313	348	264
22	11.9	17.2	22.2	32.0	41.5	50.7	68.7	94.6	136	177	216	254	292	330	366	283
23	12.5	18.0	23.3	33.6	43.5	53.2	72.0	99.3	143	185	226	267	307	346	384	303
24	13.1	18.9	24.4	35.2	45.6	55.7	75.4	104	150	194	237	279	321	362	402</			



Horsepower Ratings Single Strand Roller Chain

For Multiple Strand Ratings See Chart at Bottom

3" Pitch No. 240																				
No. of Teeth Small Sprocket	REVOLUTIONS PER MINUTE — SMALL SPROCKET																			
	5	10	15	20	25	30	40	50	60	80	100	125	150	175	200	250	300	350	400	450
11	4.86	9.08	13.1	16.9	20.7	24.4	31.6	38.6	45.5	59.0	72.1	88.1	104	119	135	164	194	223	187	156
12	5.34	9.97	14.4	18.6	22.7	26.8	34.7	42.4	50.0	64.8	79.2	96.8	114	131	148	181	213	245	218	...
13	5.83	10.9	15.7	20.3	24.8	29.2	37.9	46.3	54.5	70.6	86.4	106	124	143	161	197	232	267	240	...
14	6.31	11.8	17.0	22.0	26.9	31.7	41.0	50.1	59.1	76.5	93.6	114	135	155	175	213	251	289	268	...
15	6.80	12.7	18.3	23.7	28.9	34.1	44.2	54.0	63.6	82.4	101	123	145	167	188	230	274	311	297	...
16	7.29	13.6	19.6	25.4	31.0	36.6	47.4	57.9	68.2	88.4	108	132	156	179	202	247	290	334	328	...
17	7.78	14.5	20.9	27.1	33.1	39.0	50.6	61.8	72.9	94.4	115	141	166	191	215	263	310	356	359	...
18	8.28	15.4	22.3	28.8	35.2	41.5	53.8	65.8	77.5	100	123	150	177	203	229	280	330	379	377	...
19	8.78	16.4	23.6	30.6	37.4	44.0	57.0	69.7	82.2	106	130	159	187	215	243	297	360	402	393	...
20	9.28	17.3	24.9	32.3	39.5	46.5	60.3	73.7	86.8	112	138	168	198	228	257	314	370	423	407	...
21	9.78	18.2	26.3	34.1	41.6	49.0	63.5	77.7	91.5	119	145	177	209	240	270	331	390	439	421	...
22	10.3	19.2	27.6	35.8	43.8	51.6	66.8	81.7	96.2	125	152	186	220	252	284	348	410	454	435	...
23	10.8	20.1	29.0	37.6	45.9	54.1	70.1	85.7	101	131	160	195	230	265	298	365	430	469	448	...
24	11.3	21.1	30.4	39.3	48.1	56.7	73.4	89.7	106	137	167	205	241	277	312	282	450	483
25	11.8	22.0	31.7	41.1	50.3	59.2	76.7	93.8	110	143	175	214	252	290	327	399	470	496
26	12.3	23.0	33.1	42.9	52.4	61.8	80.0	97.8	115	149	183	223	263	302	341	416	491	509

American Standard No. 2040																	
No. of Effective Teeth in Small Sprocket	REVOLUTIONS PER MINUTE — SMALL SPROCKET																
	25	50	100	150	200	300	400	500	600	700	800	900	1000	1100	1200	1300	
11	.202	.379	.687	.958	1.19	1.41	1.59	1.89	2.14	2.32							
12	.223	.419	.766	1.07	1.34	1.58	1.81	2.16	2.46	2.71	2.88						
13	.243	.458	.842	1.18	1.48	1.76	2.00	2.44	2.79	3.08	3.31	3.48					
14	.263	.497	.914	1.28	1.63	1.93	2.20	2.67	3.09	3.44	3.70	3.91	4.10				
15	.283	.535	.989	1.39	1.76	2.09	2.40	2.93	3.38	3.77	4.08	4.32	4.52	4.67			
16	.303	.572	1.06	1.49	1.89	2.25	2.59	3.17	3.67	4.09	4.44	4.73	4.96	5.13			
17	.322	.611	1.13	1.59	2.02	2.41	2.77	3.41	3.95	4.41	4.80	5.10	5.38	5.57	5.72		
18	.342	.648	1.20	1.70	2.15	2.57	2.94	3.63	4.21	4.71	5.13	5.48	5.76	5.97	6.15		
19	.361	.687	1.27	1.80	2.28	2.72	3.14	3.86	4.49	5.02	5.48	5.85	6.17	6.41	6.61	6.70	
20	.380	.720	1.34	1.90	2.40	2.87	3.29	4.07	4.72	5.29	5.76	6.17	6.50	6.77	6.98	7.13	
21	.399	.758	1.41	1.99	2.52	3.01	3.47	4.27	4.97	5.57	6.07	6.50	6.86	7.13	7.35	7.50	
22	.419	.794	1.48	2.08	2.64	3.15	3.63	4.48	5.20	5.83	6.37	6.81	7.18	7.48	7.71	7.87	
23	.437	.829	1.54	2.18	2.76	3.30	3.79	4.68	5.42	6.09	6.64	7.11	7.49	7.80	8.04	8.21	
24	.456	.866	1.60	2.27	2.88	3.44	3.96	4.87	5.67	6.35	6.92	7.40	7.80	8.12	8.37	8.54	
25	.475	.902	1.67	2.36	3.00	3.58	4.11	5.07	5.90	6.60	7.19	7.73	8.10	8.42	8.67	8.84	
30	.568	1.076	1.99	2.81	3.56	4.24	4.86	5.95	6.93	7.76	8.40	8.90	9.38	9.72	9.95	10.09	
35	.657	1.247	2.30	3.24	4.09	4.86	5.56	6.81	7.86	8.71	9.42	9.99	10.43	10.72	10.93	10.97	
40	.748	1.413	2.80	3.65	4.59	5.44	6.22	7.57	8.67	9.60	10.31	10.86	11.23	11.49	11.61		
Lubrication type	1			2				3									

American Standard No. 2050																	
No. of Effective Teeth in Small Sprocket	REVOLUTIONS PER MINUTE — SMALL SPROCKET																
	25	50	100	150	200	250	300	350	400	450	500	550	600	700	800	900	
11	.385	.72	1.29	1.78	2.19	2.56	2.85	3.12	3.33	3.53							
12	.428	.80	1.44	1.99	2.48	2.90	3.26	3.58	3.86	4.10	4.31						
13	.457	.87	1.59	2.20	2.74	3.23	3.65	4.03	4.36	4.66	4.91	5.11	5.30				
14	.506	.95	1.73	2.41	3.01	3.55	4.02	4.45	4.84	5.17	5.48	5.73	5.96				
15	.544	1.02	1.87	2.61	3.27	3.86	4.39	4.88	5.31	5.68	6.02	6.31	6.57	6.94			
16	.582	1.09	2.00	2.81	3.52	4.16	4.74	5.26	5.73	6.16	6.55	6.87	7.19	7.61			
17	.620	1.16	2.14	2.99	3.77	4.46	5.09	5.66	6.17	6.63	7.05	7.42	7.75	8.24	8.62		
18	.658	1.23	2.27	3.19	4.01	4.75	5.41	6.03	6.58	7.09	7.54	7.94	8.31	8.84	9.28		
19	.696	1.31	2.41	3.39	4.25	5.05	5.76	6.42	7.00	7.55	8.04	8.46	8.87	9.42	9.90		
20	.732	1.38	2.54	3.56	4.48	5.32	6.07	6.75	7.38	7.95	8.46	8.92	9.35	9.97	10.49		
21	.769	1.45	2.66	3.75	4.70	5.59	6.38	7.10	7.77	8.37	8.90	9.39	9.84	10.50	11.06	11.44	
22	.806	1.52	2.79	3.92	4.92	5.86	6.69	7.45	8.14	8.76	9.33	9.84	10.31	11.01	11.59	12.00	
23	.842	1.58	2.91	4.09	5.16	6.12	6.98	7.78	8.50	9.15	9.74	10.27	10.76	11.50	12.10	12.52	
24	.879	1.65	3.05	4.27	5.37	6.38	7.28	8.10	8.85	9.54	10.16	10.70	11.21	11.97	12.59	13.03	
25	.914	1.72	3.17	4.45	5.59	6.62	7.58	8.42	9.20	9.91	10.55	11.12	11.64	12.42	13.05	13.50	
30	1.092	2.06	3.77	5.28	6.63	7.84	8.93	9.92	10.82	11.62	12.35	12.99	13.57	14.39	15.06	15.48	
36	1.267	2.38	4.35	6.07	7.59	8.96	10.18	11.27	12.26	13.14	13.92	14.59	15.17	16.00	16.62	16.94	
40	1.44	2.70	4.91	6.82	8.51	10.00	11.33	12.51	13.57	14.49	15.28	15.95	16.57	17.29	17.78		
Lubrication type	1			2				3									

Type 1: Manual drip (4 to 10 drops per minute), or splash.
 Type 2: Rapid drip (20 drops per minute minimum), splash, or disc.
 Type 3: Disc or forced.

No. Strands	Strand Factor
2	1.7
3	2.5
4	3.3

SPROCKETS

Horsepower Ratings Single Strand Roller Chain



For Multiple Strand Ratings See Chart at Bottom

American Standard No. 2060																	
No. of Effective Teeth In Small Sprocket	REVOLUTIONS PER MINUTE — SMALL SPROCKET																
	25	50	75	100	125	150	200	250	300	350	400	450	500	550	600	650	700
11	.66	1.21	1.70	2.15	2.54	2.93	3.58	4.12	4.56	4.93							
12	.73	1.34	1.90	2.41	2.85	3.30	4.05	4.70	5.24	5.71	6.08						
13	.79	1.48	2.09	2.65	3.15	3.65	4.52	5.27	5.91	6.46	6.92	7.32					
14	.86	1.60	2.27	2.90	3.45	4.00	4.97	5.79	6.54	7.17	7.72	8.18	8.58				
15	.92	1.72	2.45	3.14	3.74	4.34	5.39	6.32	7.14	7.86	8.48	9.01	9.48				
16	.99	1.85	2.64	3.36	4.01	4.66	5.82	6.82	7.73	8.52	9.21	9.80	10.34	10.77			
17	1.05	1.97	2.82	3.59	4.28	4.98	6.22	7.32	8.29	9.14	9.91	10.56	11.14	11.64	12.06		
18	1.12	2.10	2.99	3.82	4.56	5.31	6.63	7.82	8.85	9.78	10.60	11.31	11.96	12.50	12.97		
19	1.18	2.23	3.17	4.05	4.83	5.62	7.03	8.29	9.42	10.41	11.29	12.08	12.76	13.35	13.87	14.30	
20	1.25	2.34	3.34	4.26	5.09	5.93	7.41	8.74	9.92	10.97	11.91	12.74	13.46	14.08	14.64	15.10	
21	1.31	2.46	3.51	4.49	5.36	6.24	7.80	9.19	10.43	11.55	12.52	13.40	14.14	14.83	15.42	15.90	
22	1.37	2.58	3.67	4.70	5.62	6.54	8.16	9.62	10.93	12.08	13.13	14.04	14.84	15.55	16.15	16.67	
23	1.44	2.69	3.83	4.90	5.86	6.83	8.53	10.06	11.42	12.62	13.71	14.67	15.49	16.22	16.87	17.38	17.83
24	1.50	2.80	4.00	5.11	6.11	7.12	8.90	10.47	11.90	13.16	14.28	15.27	16.14	16.89	17.56	18.11	18.57
25	1.56	2.92	4.17	5.32	6.36	7.41	9.27	10.89	12.37	13.67	14.84	15.86	16.76	17.53	18.21	18.79	19.24
30	1.86	3.48	4.96	6.32	7.55	8.78	10.94	12.76	14.55	16.05	17.38	18.54	19.53	20.38	21.11	21.70	22.16
35	2.16	4.03	5.73	7.29	8.67	10.06	12.52	14.67	16.54	18.17	19.61	20.80	21.88	22.73	23.40	23.99	
40	2.45	4.55	6.46	8.20	9.70	11.31	13.99	16.33	18.35	20.08	21.57	22.84	23.86	24.64	25.42		
Lubrication Type	1						2						3				

American Standard No. 2080																	
No. of Effective Teeth In Small Sprocket	REVOLUTIONS PER MINUTE — SMALL SPROCKET																
	10	20	30	40	50	60	70	80	90	100	150	200	250	300	350	400	450
11	.66	1.24	1.78	2.26	2.76	3.20	3.60	3.99	4.38	4.78	6.36	7.60					
12	.72	1.37	1.96	2.52	3.08	3.56	4.03	4.48	4.92	5.36	7.20	8.68	9.82				
13	.79	1.49	2.15	2.77	3.36	3.91	4.44	4.95	5.45	5.93	8.02	9.73	11.08				
14	.85	1.62	2.33	3.01	3.66	4.26	4.85	5.42	5.96	6.49	8.82	10.75	12.29	13.60			
15	.91	1.74	2.52	3.25	3.95	4.60	5.25	5.86	6.45	7.03	9.60	11.74	13.46	14.94			
16	.98	1.87	2.70	3.48	4.24	4.94	5.64	6.29	6.93	7.56	10.36	12.70	14.59	16.24	17.65		
17	1.04	1.99	2.88	3.71	4.52	5.28	6.02	6.72	7.40	8.09	11.10	13.63	15.69	17.50	19.04		
18	1.11	2.11	3.05	3.94	4.80	5.61	6.40	7.14	7.87	8.60	11.82	14.53	16.76	18.72	20.38	21.77	
19	1.17	2.23	3.23	4.17	5.09	5.94	6.77	7.56	8.33	9.10	12.52	15.40	17.80	19.90	21.67	23.18	
20	1.23	2.35	3.40	4.40	5.36	6.26	7.13	7.98	8.78	9.60	13.20	16.25	18.81	21.04	22.91	24.52	
21	1.29	2.47	3.57	4.62	5.62	6.58	7.49	8.39	9.23	10.09	13.87	17.08	19.79	22.14	24.11	25.80	
22	1.36	2.58	3.74	4.84	5.90	6.89	7.84	8.79	9.67	10.57	14.53	17.90	20.74	23.20	25.27	27.03	
23	1.42	2.70	3.90	5.06	6.16	7.20	8.19	9.18	10.10	11.05	15.18	18.71	21.66	24.23	26.40	28.22	
24	1.48	2.82	4.05	5.27	6.43	7.51	8.54	9.56	10.53	11.52	15.82	19.51	22.55	25.23	27.50	29.38	30.98
25	1.54	2.92	4.20	5.48	6.69	7.81	8.89	9.94	10.95	11.98	16.45	20.30	23.42	26.20	28.57	30.52	32.16
30	1.84	3.50	5.02	6.54	7.96	9.29	10.59	11.74	12.97	14.23	19.46	23.91	27.52	30.70	33.56	35.52	37.26
35	2.14	4.07	5.82	7.56	9.19	10.71	12.21	13.48	14.92	16.35	22.26	27.23	31.21	34.65	37.57	39.66	
40	2.43	4.61	6.60	8.55	10.38	12.09	13.76	15.17	16.80	18.36	24.88	30.28	34.52	38.09	40.96	43.07	
Lubrication Type	1						2						3				

Type 1: Manual drip (4 to 10 drops per minute), or splash.
 Type 2: Rapid drip (20 drops per minute minimum), splash, or disc.
 Type 3: Disc or forced.

No. Strands	Strand Factor
2	1.7
3	2.5
4	3.3

SPROCKETS